

# AQUALISA UNITY Q™

UTQ.A1.BV.  
DVF.W.23

WITH ADJUSTABLE HEAD AND WALL FIXED DRENCHER - HP/COMBI

## DIMENSIONAL DRAWINGS

### FIXED WALL DRENCHER

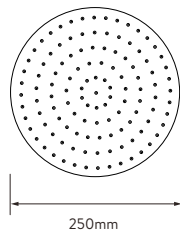
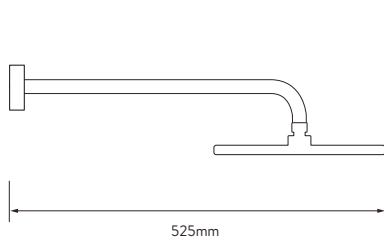

### CONTROLLER

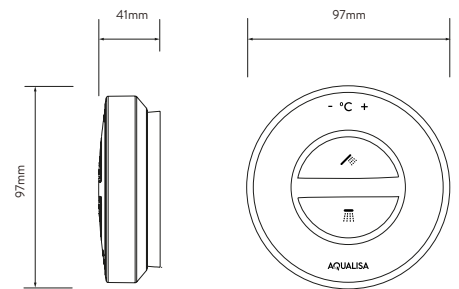

### SHOWER RAIL KIT

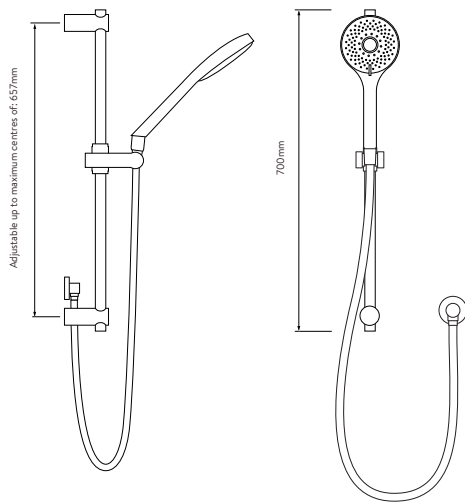

### SHOWER HEAD

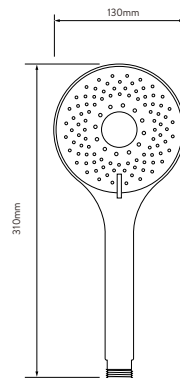

### AQUALISA SMARTVALVE™

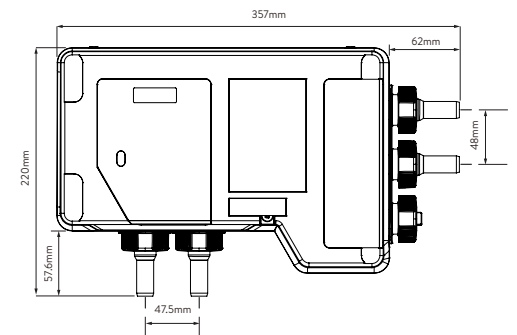

### SHOWER HOSE

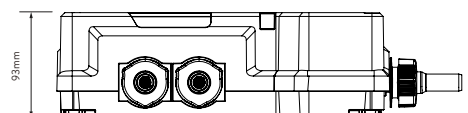
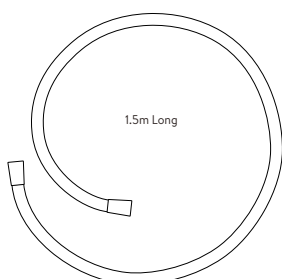

# AQUALISA

## UNITY Q™

UTQ.A1.BV.  
DVFW.23

WITH ADJUSTABLE HEAD AND WALL FIXED DRENCHER - HP/COMBI

### TECHNICAL SPECIFICATIONS

Minimum operating pressure	1 bar
Maximum operating pressure	5 bar
Peak operating pressure	7 bar
Aqualisa SmartValve™ inlet fitting connections	15mm push fit fittings, valve inlet centres 48mm, inlet supply positions – hot right, cold left
Aqualisa SmartValve™ and diverter outlet connections	15mm push fit
Permissible Aqualisa SmartValve™ and diverter siting locations	Loft, airing cupboard, under bath
Supply temperature	Cold inlet temperature 1°C (minimum) Cold inlet temperature 15°C (maximum) Hot inlet temperature 65°C (maximum)
Water system	HP / Combi / Boosted gravity
Features	One touch start/stop control
	LED display indicates when pre-selected temperature has been reached
	Wi-Fi & App compatible – control your product with your smart phone and smart home device e.g. Alexa
	App functions include start/stop, shower timer, user dashboard, usage tracker and help & support
	Aqualisa SmartValve™
	Digital diverter technology
	130mm Vita™ shower head with 3 spray patterns
Compatible with wired remote control	
Guarantee period	5-year guarantee - shower unit
	2-year guarantee - shower head and kit
Approvals	CE Marking
	UKCA
	BEAB