

How to install click Tiles

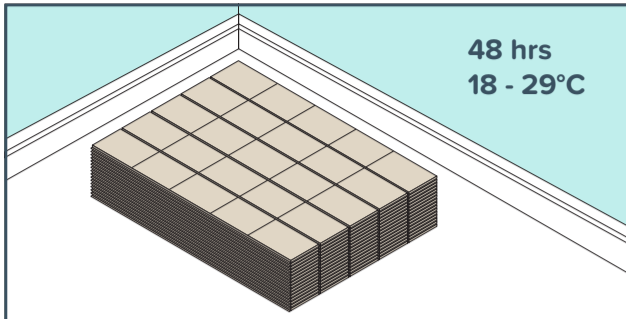

1. Acclimation Requirements - 48 hrs between 18 - 29°C. Check flooring for any damages to the tile or jointing lips. Dispose of damaged tiles. Read Instruction manual supplied in the box for preparation and in depth advise. Ensure that you plan out the cuts for both the width and length of your room. The final rows should be at least 1/3 of the width/length of the tile. If this is too narrow cut down the starting row width to ensure a reasonable width is achieved better stability.

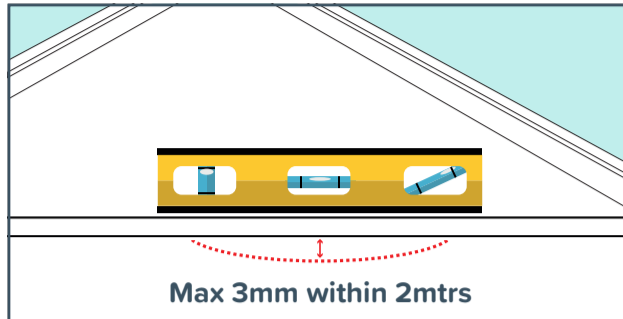

2. Subfloor Flatness Tolerances - Max 3mm within 2m (BS 8203 - SR1). Vacuum the floor to ensure the surface is free from debris. Can be used with In-floor Radiant underfloor heating. Source must be min 13mm below flooring. Max Operating floor temperature 29°C refer to instruction manual. Remove any skirting or trims prior to installation.

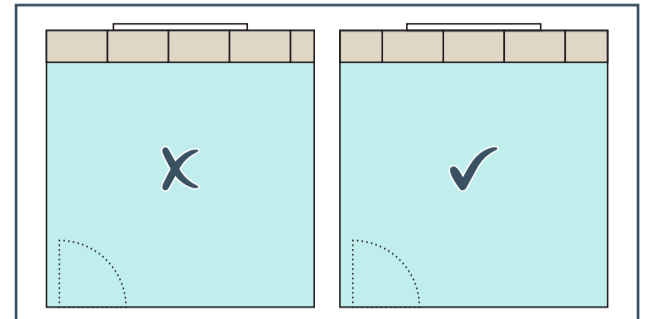

3. Lay your first row of click tiles out next to one another to determine the best fit. To achieve an even look, you may need to cut the first piece to a shorter length. It is advisable to set out your pieces so that the cuts lengths at each end are more than 20cm in length.

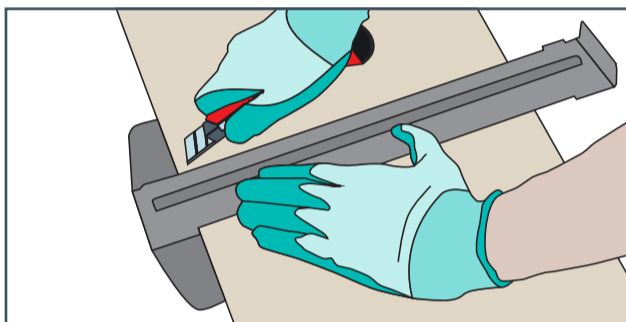

4. To cut your click tiles to size, measure and mark with a pencil. Using a T-square and utility knife, apply pressure and score along the line. Gently flex along the scored edge until it separates into two pieces.

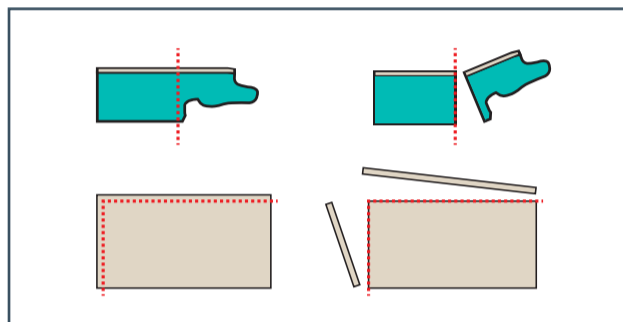

5. To achieve a perfect fit, always fit a cut edge next to walls rather than a locking profile. For pieces that sit in the corner of a room, this will mean cutting both the long and short edges to remove the locking profile.

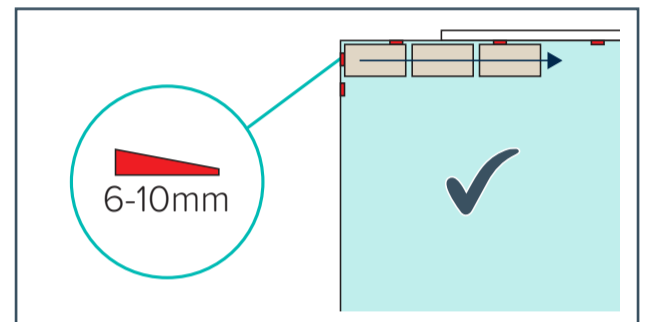

6. Begin installing click tiles from the left side of your room and always work to the right. Use spacer wedges next to any piece that meets a wall to ensure a 6-10mm expansion gap (dependent on room size) is left around the perimeter.

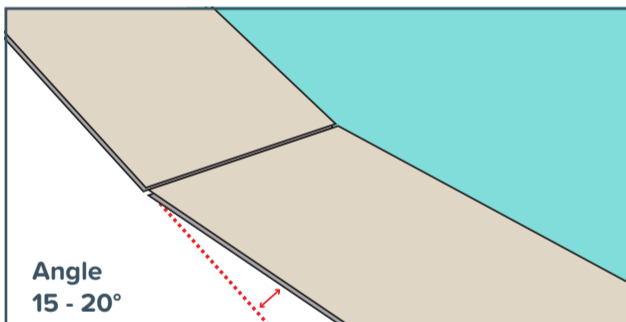

7. To start the first row, place the tiles against the wall and the groove joint facing away from the wall. To insert the short edges, insert the tongue into the groove at an angle of approximately 20°, with lightly applied pressure, lower the tile to engage the joint. Make sure seams are aligned, tight and with no separation. Use tapping block to align and seat where required. Continue to install further pieces until the first row is complete.

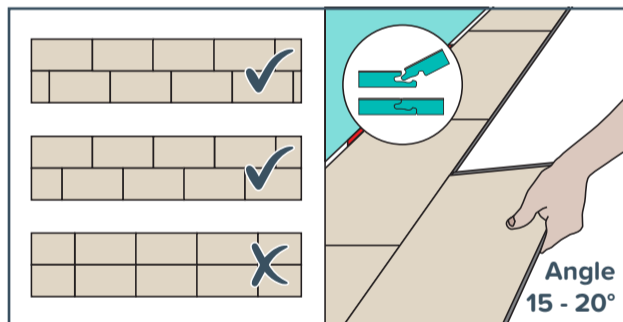

8. To fix the first tile of the second and consecutive rows, insert the long tongue side into the long groove side of the previous piece at an angle of around 20°. Gently apply inwards and downwards pressure until the joint closes. The tile can then be pushed / tapped flat to lock the joints into place. Always ensure the joints are staggered by at least a third.

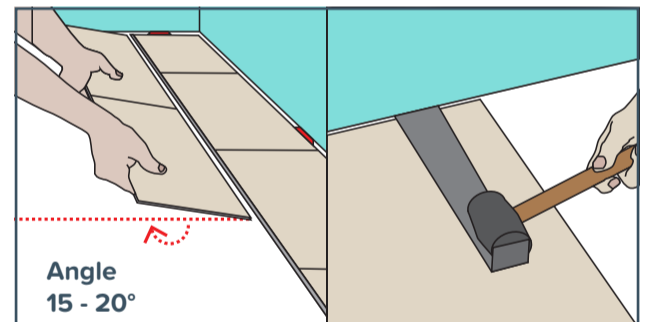

9. Continue to lay tiles along the row. Always connect the short edge first, then lift and angle the long edge into place. As you angle the long edge, the previous tile will lift at the same time. Slide/ Push the long joints together to ensure that there are no gaps before lowering the tile into position. A pull bar / tapping block can be used to ensure the tile joints are tight and seated correctly. The key to a successful install is to ensure the first two / three rows are correctly fitted with the joints aligned, secured and no gaps or broken joints. If you damage a joint, do not re-use the tile as this could lead to failures throughout the installation.

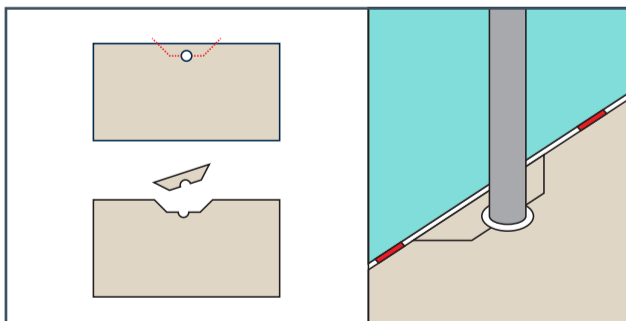

10. Click tiles can be easily fit around pipes by using a hole saw. Use a utility knife and cut a few centimeters away from the hole horizontally then at a 45° angle to the edge. Always leave a minimum expansion joint of 6-10mm around all pipes and objects. Reattach the pieces together using a vinyl seam sealer and wipe away any excess glue with a damp cloth.

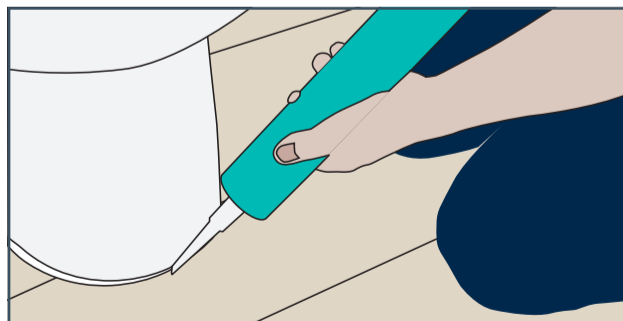

11. For splash areas such as bathrooms, waterproof skirting/ scotia/trims can be used. Cut the flooring around your WC base leaving a 6-10mm expansion joint. 100% silicone sealant can be used around the expansion gap of a WC or small wet areas (sink pedestal), but cannot be used in large areas as this will restrict the expansion and contraction of the tiles and cause the joints to fail.

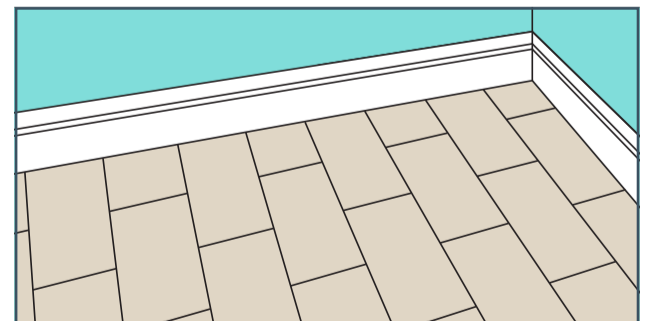

12. Continue to work left to right row by row. Once the floor is complete, remove the spacer wedges. Finish the look with skirting boards around the perimeter to conceal the expansion gaps. The skirting must be fixed to the walls and not the floors. Cut your flooring around heavy objects, furniture and pipework leaving a 6-10mm expansion joint (dependent on room size). All door thresholds must also have 6-10mm expansion joints incorporated to enable the flooring to expand and contract. Protect SPC Flooring from exposure to direct sunlight via the use of window-treatments or UV-tinting on windows.

DO-IT-YOURSELF INSTALLATION

IMPORTANT: Unilin Click System is installed without glue, nails, or other fasteners. The Individual tiles should not be fixed to the subfloor. It is designed to be installed as a floating floor and must be allowed to expand and contract freely. Do not install in any external areas or rooms that are prone to flooding or that are not temperature controlled. Permanent cabinets, vanities, islands, and similar items should be installed first, then, the flooring installed around them. Leave a minimum expansion gap around the perimeter of the room, and all permanent fitted items. Expansion gaps must also be implemented in all door/entrance thresholds.

Protect SPC Flooring from exposure to direct sunlight via the use of window / door- treatments or UV-tinting.

SPC Flooring is not recommended for heavy rolling or static loads. SPC flooring can be used with radiant heated floors, both electric and water piped systems. The distance from the heating system to the top surface of the floor must be at least 12mm. The floor temperature must not exceed 90 F. Before installing the floor, the heating system should be turned on to eliminate moisture.

Flooring transition strips must be used in areas larger than 37 linear ft. (11.3 Lm).

The SPC flooring comes complete with its own pre-attached underlay. Do not Install an additional underlay as this will causing damage to the tile joints and will void the warranty.

The edges (tongues and grooves) are engineered to lock together creating a secure bond along all four sides of each tile, making installation easier, faster, and cleaner while allowing your new floor to be used immediately after installation.

MATERIALS YOU MAY NEED:

- Patch/underlayment/embossing leveler - to level surface and patch cracks.
- Utility knife and straight edge.
- Measuring tape.
- Shears or tin snips for cutting around irregular shaped objects.
- Marker Pen, Gloves, Rubber Hammer.
- Unilin Click System tiles - make sure you purchase at least 10% extra to cover mistakes or for possible future replacements and repairs.

IMPORTANT: Purchase all tiles at the same time and check to make sure all item numbers match before leaving store.

SUITABLE AREAS:

Excellent for all areas of your home including kitchens, entryways, rec rooms, laundry rooms and commercial installations such as shops, salons, professional and business offices, entryways and break rooms.

SUITABLE SURFACES:

- Smooth surfaces that are flat, level, structurally sound and rigid. Flatness tolerance for all surfaces must be prepared to BS 8203:2017 – Class SR1. must not exceed 3mm in 2m (1/8" over 6') - with no abrupt height differences. High spots must be sanded or ground down and low areas filled.
- Clean surfaces that are free of dust, dirt, grease, paint, old adhesive residue, carpet staples and moisture.
- Plywood, chipboard, flakeboard, waferboard, particleboard or OSB.
- Concrete floors that are dry, and free of dust, solvents, grease, and oil. New concrete must be thoroughly dry and cured for at least six weeks.
- Ceramic and stone floors as long as they have been made smooth and level with a patch/underlayment/embossing leveler.

UNSUITABLE SURFACES :

- Carpet, foam underlayment or heavily cushioned floors.
- Concrete surfaces below grade where moisture may be a problem. Unilin Click System is waterproof and is not susceptible to water damage. However, excessive moisture in the subfloor beneath the tile may allow for the growth of mould or mildew (see concrete moisture test below).
- Heavily embossed floors, unless the embossed surface is filled with a suitable patch, underlayment, or embossing leveler.
- Floors that are not flat or level will cause flooring to buckle and break flooring mechanisms.

CONCRETE SUBFLOOR MOISTURE TESTING PROCEDURE:

If you are unsure whether moisture is a problem, cut a few two-foot square pieces of polyethylene and duct tape them to several areas of the concrete subfloor. Wait about 72 hours and then lift the corner of each test square. If the plastic is dry, then moisture is within the acceptable levels. If there is condensation on the underside of the plastic, or if the floor beneath is damp, then the moisture level may not be acceptable.

IMPORTANT: Store the Unilin Click System Tiles horizontally in the room where it will be installed for at least 48 hours prior to installation. Make sure the room temperature is between 18 degrees and 29 degrees Celsius for at least 48 hours prior to installation and for the life of the floor.

PREPARING THE SUBFLOOR:

CONCRETE FLOORS:

Concrete must be smooth, clean, flat, and free of moisture. Remove all dirt, grease, and adhesive residue. Sweep and vacuum the floor thoroughly. Fill all cracks and holes with a suitable patch/underlayment/embossing leveler per manufacturer's instructions.

WOOD FLOORS:

Securely nail all loose boards. Scrape, plane or fill uneven boards with a suitable patch, underlayment, or embossing leveler.

If the surface is still not smooth, then we recommend installing a 1/4" underlayment panel over the wood subfloor.

OLD FLOOR COVERINGS:

Tiles may be installed directly over any well-bonded, smooth surface. Tiles should not be installed over heavily cushioned floor materials. Tiles should not be installed over heavily embossed tiles unless the embossing has been filled in with a suitable patch, underlayment, or embossing leveler. Your Unilin Click System Tiles may even be installed over ceramic tiles if the surface is smooth, and the grout lines and any other irregularities are filled with a suitable patch/ underlayment/embossing leveler.

WARNING :

NEVER SAND EXISTING RESILIENT FLOOR, AS THE DUST MAY CONTAIN HARMFUL ASBESTOS FIBERS.

PATCHING OR LEVELING:

Patch, fill, level and smooth any holes, cracks, or surface irregularities. The floor must be level within 1/8" over 6' (3mm over 2m) in all directions. Make sure that the floor is smooth, clean, and completely free of wax, grease, oil or dust before laying the tiles. Any roughness or unevenness in the subfloor may eventually show through, detracting from the genuine appearance of your floor as well as causing excessive wearing in those areas.

BEFORE INSTALLING TILES:

Tiles and the room where the tiles are being installed must be maintained at a stable temperature of around 18°C - 29°C for at least 48 hours prior to, during and after installation. Installed tiles must always be maintained at a stable, controlled temperature of between 18°C and 29°C for the life of the product.

FOR BEST VISUAL RESULTS:

- Check to see that all pattern and item numbers are the same.
- Always mix tiles from several boxes to avoid installing tiles with similar patterns/colours next to each other.
A little time spent carefully selecting tiles from several boxes will significantly reduce the effect of any shade variations as well as increase the authenticity and beauty of your floor.
- Before installation, carefully inspect each tile for blemishes and visual defects. For visual defects: installation constitutes acceptance.

INSTALLING TILES:

LAYING THE FIRST THREE ROWS:

1. Remove wood skirting / mouldings around the perimeter of the floor.
2. Lay the long dimension of the tiles parallel to the long dimension of the room.
3. It is important to plan your layout to avoid an unbalanced installation with narrow tile widths or short end lengths at the walls. Always plan your layout to prevent having less than a half tile width at the side walls and no less than 12" lengths at the end walls.
4. Measure the width of the room at the front, middle and back and divide the widths of each measurement by the width of a tile. If the remainder is less than half the tile width, then the tiles on your starter row should be narrowed to make the last row approximately half the width of the tile. The width of the last tile should be approximately the same width as the first tile.

Please note: This may also be figured out by laying down loose tiles across the width of the room without securing them to each other and making the necessary adjustments.

5. Same for the length. Measure the length of the room wall and divide by the length of a tile. If the remainder is less than 12", then you need to cut the first tile down to make the remainder 12" or longer.

Begin installing the first row of tiles along the left side wall from the left front corner with the tongue side facing the wall. Lay down your first tile, then insert the tongue end of the second tile into the groove end of the first tile at an angle of approximately 20 degrees and push down. You should feel the tiles lock together. It is very important that the tiles line up perfectly, the joints are tight and do not pull apart, and the seams are tight without any gaps.

Expansion gaps required will depend on the size of the room:

- Minimum 6.35mm expansion gap for a room size up to 8.5 Linear Metres
- Minimum 8.3mm expansion gap for a room size up to 10 Linear Metres
- Minimum 10mm expansion gap for a room size up to 11.3 Linear Metres

Any rooms over 11.3Lm must use room divider braces (transition strips) to divide the floor into smaller area. Do not install product against wall, columns, or cabinets without leaving the correct expansion gaps.

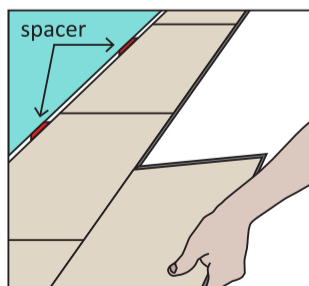

CUTTING THE LAST TILE IN THE FIRST ROW:

Mark the last tile, score it with a straight edge and utility knife, and break it at your scoring line.

INSTALLING THE FIRST AND SECOND TILE OF THE SECOND ROW:

- Insert the tongue on the side of the first tile of the second row into the groove of the first tile in the first row at an angle of approximately 20 degrees. With lightly applied pressure, click the tongue into the groove. Make sure the seams are tight with no separations or gaps.

- Interlock the end of the second tile with end of the first tile, leaving the second tile long side tongue just over the first-row tile groove. Then at a very low angle, slide/push the lengths together. Check to make sure there are no gaps in the end or long side seams.

The seams must be tight with no separation at the ends or along the side.

- Continue laying tiles, one row at a time.
- Pause, check, then recheck the first three rows again to make sure everything is straight and square without any gaps in the seams. These three rows are the foundation for the rest of your floor.
- Don't forget to keep the gap as above. Your flooring will expand and contract with temperature changes within the home as well as direct sunlight.
- To fit tiles around obstacles, make a pattern of the area on paper or cardboard, trace the pattern onto the tile and cut.
- To fit a partial tile on the last row, first place a loose tile (B) directly over the last whole tile (A) closest to the wall. Then butt another tile (C) against the wall overlapping tile (B) and mark tile (B) where it is to be cut (see Illustration #1). Do not cut on floor, as you may cut through and damage new tiles. Check to see if the fit is acceptable, then click lock the tile (B) into place.

ILLUSTRATION 1

SIDE ELEVATION

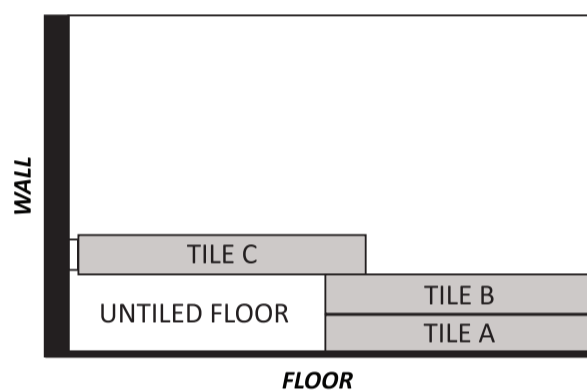

When you are done, remove all spacers along the walls and install moldings over the tiles. When installing the moldings, always fasten them to the wall, not to the tile.

CARE AND MAINTENANCE OF YOUR NEW FLOOR:

Your new floor is now ready to show with pride! You may wash the floor immediately. Always use chair protectors, mats and rugs to help prevent scratching. Regular sweeping or vacuuming and occasional washing with clean warm water will keep your new floor clean and beautiful. Use a damp sponge mop rinsed with a mild, no-wax floor cleaner to clean your new floor. This is a high-quality vinyl floor that if maintained, will last for years. If not protected properly, as with other floor covering such as hardwood and laminate, it will scratch. Scratches may be caused by pets, furniture, rocks from shoes, and many other abrasive items.

WARRANTY INFORMATION

Limited 20 Year Residential:

This product is warranted by the manufacturer to the original purchaser against manufacturing defects when installed and maintained according to the instructions printed or supplied within each carton. Under this warranty, the manufacturer will repair or, at his option, furnish replacement material of similar design, colour, and quality as the defective material. If a manufacturing defect becomes evident within the warranted period, you should notify the retailer immediately, in writing, and supply proof of purchase, a detailed description of the defect, along with a sample, and /or photograph if possible. No other expressed warranties are given. Repair or replacement of the defective product is your only remedy. In no event shall the manufacturer be liable for consequential or incidental damages or expenses of any kind or amount no matter what the cost.

This warranty does NOT cover the following:

- Any usage other than interior residential.
- Labour and/or material costs involved in removing defective product and installing the replacement.
- Damage due to excessive moisture, alkaline substances, or hydrostatic pressure in the subfloor.
- Dissatisfaction due to improper installation and maintenance.
- Damage due to stains, scratches, gouges, scuffs, indentions, punctures, tears or burns.
- Accidental discoloration due to extended exposure to sunlight.
- Seasonal Dwellings, unheated porches, or installations where there are extreme temperature variations.
- Intentional misuse.