

HOMEBASE

43CM KETTLE CHARCOAL BBQ

INSTRUCTION MANUAL



IMPORTANT: Please read these instructions before using the product and retain for future use.

HHGL Limited, MK9 1BA
HHGL (ROI) Limited, D02 X576

















Before using the product





After unpacking and before use, check the product for damages.



Should the product be damaged, do not use it and contact your retailer

Read the safety instructions and instructions for use thoroughly before using the product. Doing so will allow you to use all the product's functions safely and reliably. Retain instructions for future use.

Components - parts

| | | | | | | | | |
|---|---|-----|----|--|-----|----|---|-----|
| 1 |  | x 1 | 7 |  | x 1 | 11 |  | x 1 |
| 2 |  | x 2 | 8 |  | x 1 | 12 |  | x 2 |
| 3 |  | x 3 | 9 |  | x 1 | 13 |  | x 1 |
| 4 |  | x 1 | 10 |  | x 1 | 14 |  | x 1 |
| 5 |  | x 1 | | | | 15 |  | x 2 |
| 6 |  | x 2 | | | | 16 |  | x 1 |
| | | | | | | | | |

| | | | |
|---|---|----------------|----|
| A |  | M5x10 mm Screw | 2 |
| B |  | M6x12 mm Screw | 10 |
| C |  | M6x30 mm Screw | 3 |
| D |  | M5 Nut | 2 |

| | | | |
|---|---|-------------|----|
| E |  | M6 Nut | 10 |
| F |  | M6 Washer | 7 |
| G |  | M8 Lock Nut | 2 |

Please check you have all the components and fittings listed. If you find any missing or damaged parts, please contact our customer services team on 0333 003 7084 between 09:00 & 18:00, or use the contact form on our website www.homebase.co.uk

Intended use

Use this grill to heat, cook and grill food.

This barbecue is intended exclusively for outdoor use and not for use indoors.

Use the product only according to the description in this user manual. Any other type of use is improper and can lead to damage to property and even personal injury.

The manufacturer accepts no liability for damages due to improper use.

For your safety

Signal symbols

DANGER: High risk!

 Disregarding this warning can lead to danger to life and limb.

ATTENTION: Moderate risk!

 Disregarding this warning can lead property damage.

CAUTION: Low risk!

 Facts you should know when using the product.

GENERAL SAFETY INSTRUCTIONS

- **WARNING!** This barbecue will become very hot; do not move it during operation.
- Do not use indoors.
- **WARNING!** Do not use spirits or petrol for lighting or relighting.
- Use only firelighters complying to EN 1860-3.
- **WARNING!** Keep children and pets away.

Do not use the barbecue in a confined and/or habitable space, e.g. houses, tents, caravans, motor homes or boats. Danger of carbon monoxide poisoning fatality.



Safety instructions

DANGER: Fire hazard!

 Live coals and BBQ components get very hot during operation and can start fires.

- Always keep a fire extinguisher and a first aid kit nearby and be prepared for an accident or a fire.
- Place the grill on an even, horizontal, secure, heat-resistant and clean surface.
- Set up the grill with at least 1 metre clearance to highly-flammable materials, such as awnings, wooden patios or furniture.
- Do not move the grill during use.
- Ignite the coals at a sheltered location.
- Fill the barbecue with a maximum of 2kg of charcoal.
- Some foods produce combustible grease and juices. Clean the grill regularly, preferably after each use.
- Empty the ashes only once the charcoal is completely burned out and cooled down.
- Never leave the grill unattended during use.

DANGER: Risk of burning and accidents!

-  This product is not intended to be used by persons including children with reduced physical, sensory or mental abilities or a lack of experience.
- All modifications to the product present a great safety risk and are prohibited. Do not tamper with the device yourself in case of damages, repairs or other problems with the grill contact your local store.
 - Keep children and pets away from the product The barbecue charcoal and food get very hot during use so that contact with them can cause serious burns.
 - Keep away from hot parts as any contact can cause severe burns.
 - Always wear oven or barbecue gloves when grilling.
 - Use long-handled barbecue utensils with heat-resistant handles only.
 - Do not wear any clothing with wide sleeves. Tie back long or loose hair.
 - Only use dry igniters or special barbecue lighter fluid in compliance with EN 1860-3 to start the barbecue.
 - Let the grill cool down completely before cleaning and/or storage.

DANGER: Risk of explosion!

-  Flammable liquids poured into the embers cause rising flames or explosions.
- Never use combustible fluids, such as petrol or spirits
 - Do not put any charcoal pieces soaked in flammable liquids on the embers.

DANGER: Risk of poisoning!

-  When burning charcoal, barbecue briquettes, etc. carbon monoxide is produced. This gas is odourless and can be deadly in enclosed rooms.
- Use the grill outdoors only.

DANGER: Health hazard!

-  Do not use any paint solvents or thinners to remove stains. Such liquids are hazardous to health and must not come into contact with food.

DANGER: Hazards for children!

-  Never let children play with packaging material.
- Make sure that children do not place any small assembly parts in their mouth. They could swallow small parts and suffocate.

DANGER: Risk of injury!

-  Both the grill and individual parts may have some sharp edges.
- Be careful with individual parts to prevent accidents and/or injury during assembly and wear protective gloves if necessary.
 - Do not set up the grill near entryways or heavily trafficked areas.
 - Always exercise extreme caution while grilling. You could lose control of the product if you are distracted.
 - Always be attentive and aware of what you are doing. Do not use the product when you are lacking in concentration or are tired and/or under the influence of drugs, alcohol or medication. One moment of inattention while using the product is enough to lead to severe injury.

ATTENTION: Risk of damage!

-  During use, the screws can loosen slowly and impair the grill's stability.
- Check that all screws are tightened before use. If necessary, tighten all screws to guarantee stability.

ATTENTION: Risk of damage!

-  Do not use any strong or abrasive solvents or scouring pads, as such products attack the grill's surfaces and leave permanent markings

Assembly

DANGER: Risk of injury!

-  Failure to follow these instructions can lead to problems and risks while using the grill.

Follow each assembly step described here:

1. First, read the assembly instructions thoroughly.
2. Allow yourself enough time for assembly and find an even working space of two to three square metres.
3. Small parts, such as handles, may be preassembled.
4. Look out for sharp corners and wear protective gloves for assembly.

Required tools

- 1x Phillips screwdriver
- 1x Adjustable wrench

Assembly Instructions

Step 1- Unpack BBQ

Unpack the barbecue and dispose of packaging materials. Keep the packaging materials out of the reach of children and dispose of them according to regulations after barbecue assembly. Please follow the following steps to assemble the grill.

Step 2- Attaching the legs and wheels & wheel caps.

A. Take one of the long legs (11) and remove the screw (C) and washer (F) from its top.

Place a leg cup (3) over the top of the leg (11).

Note that the hole in the cup must go onto the leg first, so the cup points upwards.

Push the screw (C) and washer (F) through any one of the three holes in the bottom of the fire bowl (8).

Next, screw into the top of the leg (11), making sure the leg cup (3) sits squarely against the bottom of the fire bowl (8).

At this point, do not fully tighten the screw (C), but leave some movement in the leg (11).

Now, attach the other two short legs (12) in the same way.

B. Insert the bottom wire shelf (14) into the three legs (11+12) ends.

The bent tip of the shelf (14) will go into the hole of the first.

The bent tip must point in the opposite direction of the fire bowl (8).

Once you have done this, align and insert the three added ends of the shelf into their corresponding holes in the short legs.

You will have to push the legs outward slightly to do this.

C. Attach the wheels (6) on the threaded end of the wire shelf (14) with lock nuts (G).

Turn the unit upright again. Now tighten each bolt inside the fire bowl (8) to secure each leg.

D. Attach the wheel caps (15) to the wheels (6).

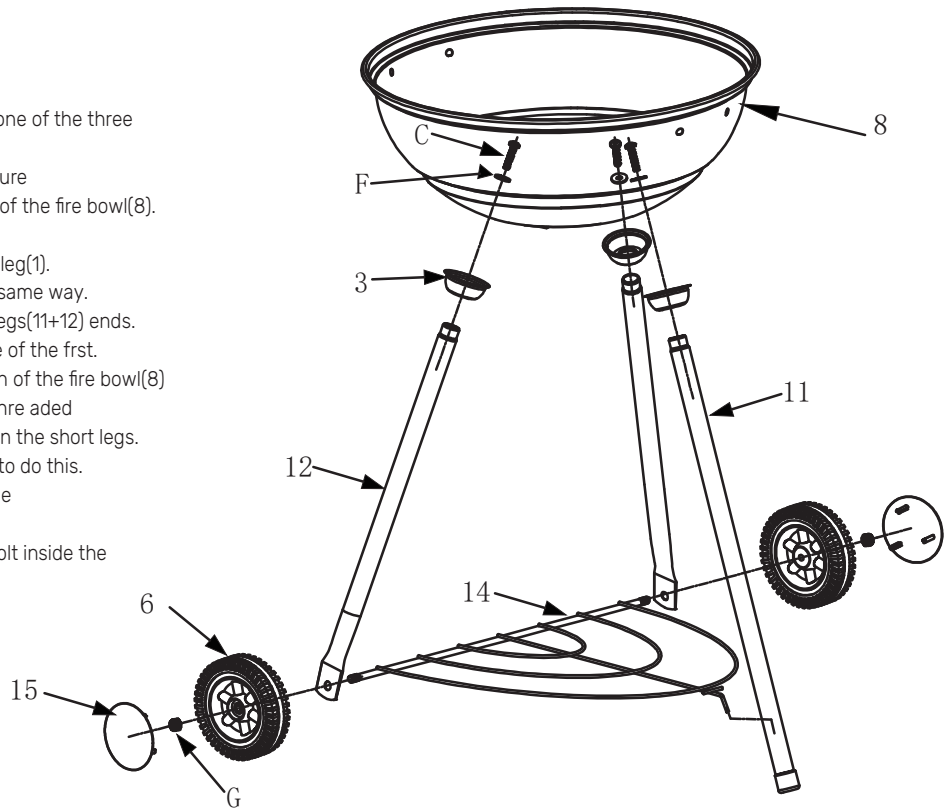

Step 3- Attaching the firebowl handles and ash vent and ash tray.

A. Attach the firebowl handles (2) to the firebowl (8) using the screws (B), nuts (E) and washers (F).

B. Attach the ash vent (5) to the firebowl (8) using the screw (A) and nut (D).

C. Fix the ash tray (13) to the three legs.

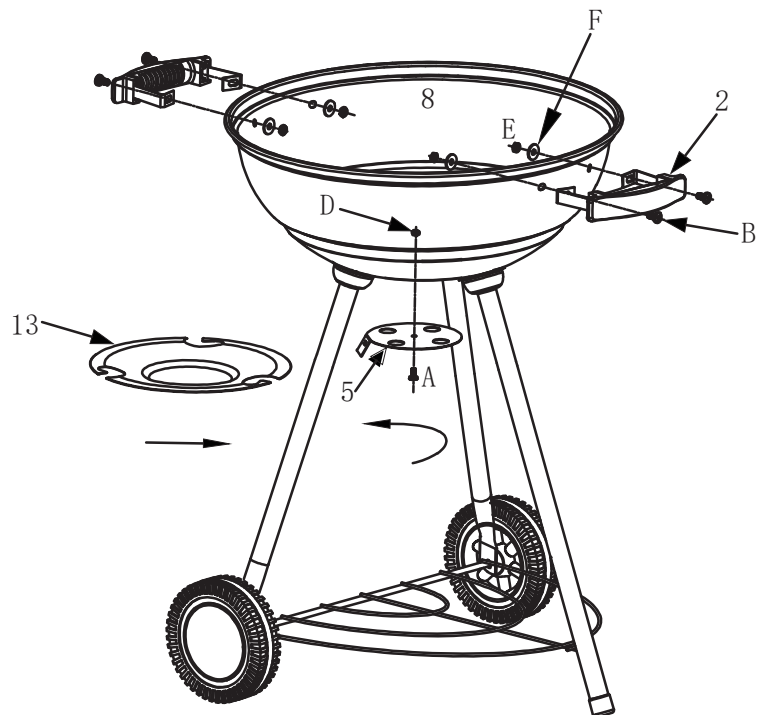

Step 4- Installing the handles and air ash.

- A. Attach the air ash(4) to lid(7) using screw(A) and nut(D).
- B. Attach the lid handle(1) and lid bracket(16) to lid(7) using screws(B) and nuts(E).

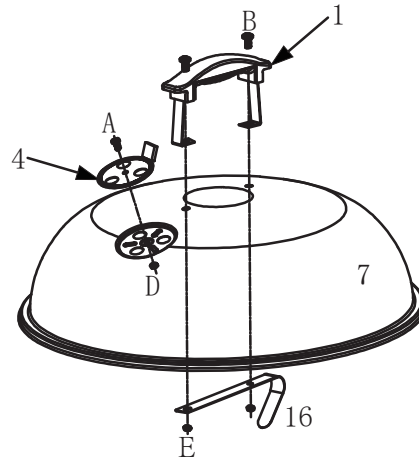

Step 5- Installing the charcoal grate and cooking grill

- Place the cooking grill(9) and charcoal grate(10) onto firebowl.
- All screws must be firmly tightened.
- Your kettle barbecue is now ready for use!

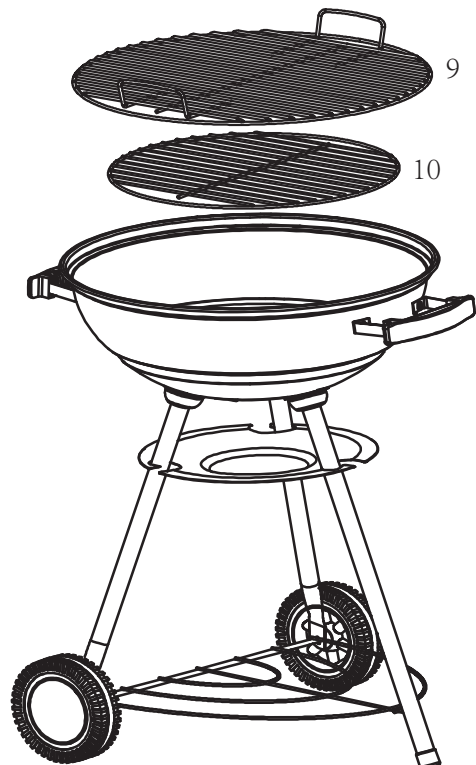
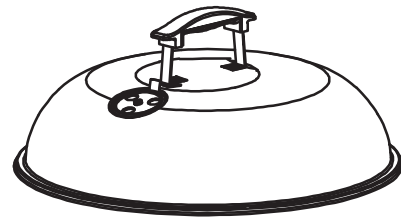

Step 6- Installing and closing the lid.

All screws must be firmly tightened.

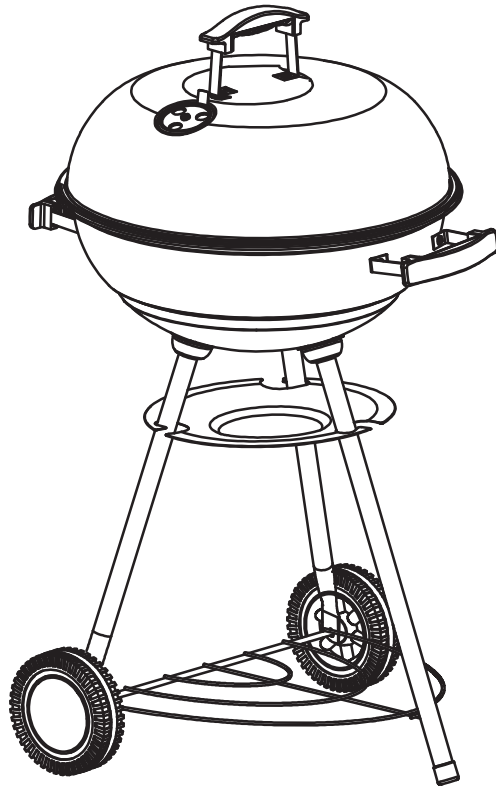

Setting up the grill

ATTENTION: Risk of damage!



During use, the screws can loosen slowly and impair the grill's stability.

- Check that all screws are tightened before use. If necessary, tighten all screws to guarantee stability.
- When using the grill, please protect the floor and surrounding walls from possible soiling, e.g. through grease splashes.
- Before use, place the barbecue on an even, sturdy surface outdoors.

Before grilling

Remove the cooking grill (6) and clean it thoroughly in soapy water. Rinse the barbecue grate with clean water. Thoroughly dry the grate and then reinstall it on the barbecue.

Conditioning before first use

Before you use the grill for the first time, it needs to be conditioned for at least 1-2 hours at a temperature of 100°C-200°C. This is necessary to prepare the inside of the grill.

Operation

DANGER: Risk of burning!



The grill, the charcoal and barbecue meat become very hot during use. Any contact can result in serious burns.

- Keep away from hot parts as any contact can cause severe burns.
- Always wear oven or barbecue gloves when grilling.
- Use long-handled barbecue utensils with heat-resistant handles only.
- Do not wear any clothing with wide sleeves. Tie back loose or long hair.
- Only use dry igniters or special barbecue lighter fluid in compliance with EN 1860-3 to start the barbecue:

1. Remove the lid (4) and cooking grill (6).
2. Place 1-2 pieces of solid igniter in the centre of the charcoal grate (9). Heed the manufacturer's instructions on the packaging. Light the igniters with a match.
3. Stack a maximum of 2kg of charcoal around the igniter.
4. Let the barbecue burn for at least 30 minutes before first time use. See section 'Before grilling' above.
5. As soon as the charcoal has heated through, distribute it evenly over the charcoal grate (9). To do so, use a suitable fireproof tool with a long fireproof handle.
6. Begin barbecuing once the charcoal is covered with a light ash layer.
7. Place the cooking grill on the mount in the firebox (10). When the barbecue is hot, wear barbecue gloves when touching the cooking grill handles.
8. When barbecuing with direct heat distribute the foods to be barbecued evenly on the cooking grill (6) and barbecue at high temperatures of approx 280°C to 320°C. This method is suitable for sausages and meat that will not be cooked for more than 25 minutes.
9. You can close the lid (4) to prevent flames. Control the air intake using the air damper (2) on the lid and cinder pot (2). Check the food from time to time, and turn it over to prevent the food from getting too dark.

Cleaning and maintenance

Your grill is made of high-quality materials. To clean and maintain the surfaces, please heed the following instructions.

DANGER: Risk of burning!



Let the grill cool down completely before cleaning.

Empty the ashes once the fuel has burned down completely and is out.

DANGER: Health hazard!



Do not use any paint solvents or thinners to remove stains. Such liquids are hazardous to health and must not come into contact with food.

ATTENTION: Risk of damage!



Do not use any strong or abrasive solvents or scouring pads as such products attack the grill's surfaces and leave permanent markings.

- Let the fuel burn out completely after grilling. This eases the cleaning effort by burning away excess fat and barbecue residues.
- Empty out the cold ash. It is very important you remove the ash before moisture comes into contact with the cold ash. Ash contains salt and affects the inside of the ash collection tray when damp. Therefore, the ash collection tray can be damaged by rust over the years.
- Clean the barbecue regularly, at best after every use.
- Remove the cooking grill (6) and clean it thoroughly in soapy water. Rinse the barbecue grate with clean water. Thoroughly dry the grate and then reinstall it on the barbecue.
- Use a wet sponge to remove loose residue from the grill.
- Use a soft, clean cloth to dry. Be careful not to scratch the surfaces while drying.
- In general, clean the inner and outer surfaces with warm soapy water.
- Tighten all screws before every use to guarantee stable footing for your barbecue at all times.
- IMPORTANT: The barbecue should always be protected from moisture.
- Protect the barbecue against the elements.

WARNING!

Every care has been taken in the production process to eliminate sharp edges on your grill. Please handle the parts with care so as to avoid accidents or injury during assembly and when in use.

Take careful note before use.

Always select a safe and even location in a place suited for a charcoal barbecue. Do not transport the grill when it is still hot. It is dangerous to attempt to operate the grill with liquid fuels.

It is recommended that the barbecue should be heated up and the fuel kept red hot for at least 30 minutes prior to your first cook. The maximum amount of charcoal weight in the firebowl is approximately 2kg.

The correct ignition procedures.

Place three or four lighting blocks in the centre of the barbecue firebowl and light with a match. Place pieces of charcoal around each burning block. Add more charcoal as required, in a pyramid formation. When burning is established, spread the fuel out evenly.

Tips on lighting charcoal.

Heap charcoal pieces into a pyramid in the firebowl.

Position dry charcoal lighters evenly through this pyramid of charcoal. Light the pyramid using a match.

Do not cook before the fuel has a coating of ash.

Oil grilling skewers with a little vegetable oil and begin your barbecue.

Warning

Always wear heat-resistant gloves when moving the grill; the cooking grid handles can become very hot during cooking. When preparing food or placing charcoal, always wear barbecue mitts. Always use barbecue tools with long, heat-resistant handles.

WARNING! Keep children and pets away.

Use outdoors only.

Never leave a barbecue unattended.