

# HOMEBASE

## DOUBLE HANGING CHAIR

---

INSTRUCTION MANUAL

---



**IMPORTANT:** Please read these instructions before using the product and retain for future use.

HHGL Limited, MK9 1BA  
HHGL(ROI) Limited, DO2 X576

## SAFETY & CARE ADVICE







Please read these instructions fully before starting assembly.





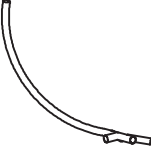





- Check you have all the components and tools listed on page 2.
- Remove all fittings from the plastic bags and separate them into their groups.
- Keep children and animals away from the work area; small parts could choke if swallowed.
- Make sure you have enough space to lay out the parts before starting.
- Do not stand on the product, as this could cause damage.
- Assemble the item as close to its final position as possible.
- Assemble on a soft, level surface, to avoid damaging the product or your floor.
- Parts of the assembly will be easier with 2 people.
- We do not recommend the use of power drills/drivers for inserting screws, as this could damage the unit. Only use hand screwdrivers.
- Dispose of all packaging materials carefully and responsibly.
- Only clean using a damp cloth and mild detergent; do not use bleach or abrasive cleaners.
- From time to time, check that there are no loose screws on this unit.
- This product should not be discarded with household waste.
- Take to your local authority waste disposal centre.
- Maximum weight capacity: 200kg.

## COMPONENTS- PARTS & FITTINGS

Please check you have all the components and fittings listed. If you find any missing or damaged parts, please contact our customer services team on 0333 003 7084 between 09:00 & 18:00, or use the contact form on our website [www.homebase.co.uk](http://www.homebase.co.uk)

**NOTE:** The quantities below are the correct amount to complete the assembly. In some cases, more fittings may be supplied than required.

NO.	DIAGRAM	QTY
A		x 1
B		x 2
C		x 1
D		x 1
E		x 4
F		x 1
G		x 2
H		x 1

NO.	DIAGRAM	QTY
I		x 4
J	 M:8*60MM	x 4
K		x 4
L		x 14
M		x 1
N		x 4
O		x 1
P		x 2
Q		x 2
R		x 2
S	 M8*70MM	x 2

# ASSEMBLY INSTRUCTIONS

Step 1

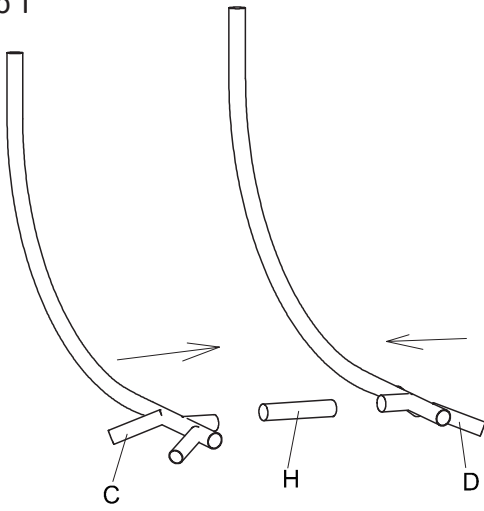

Step 2

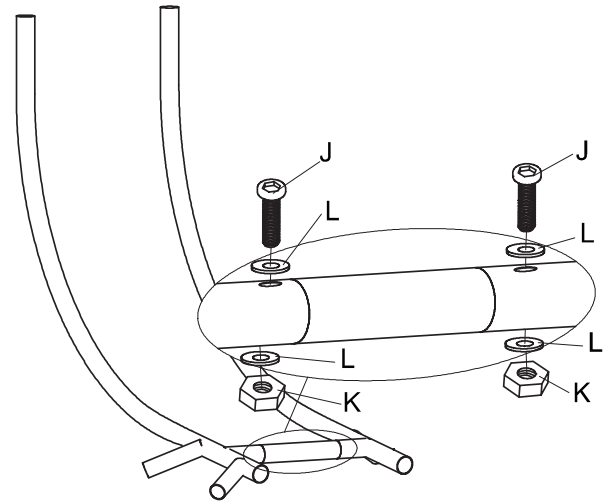

Step 3

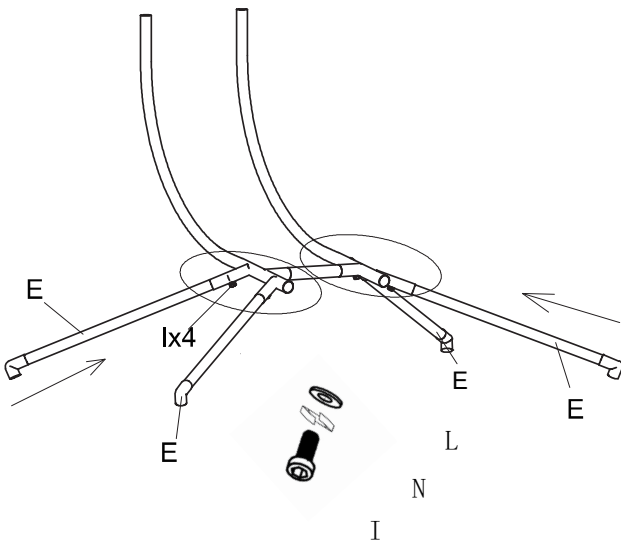

Step 4

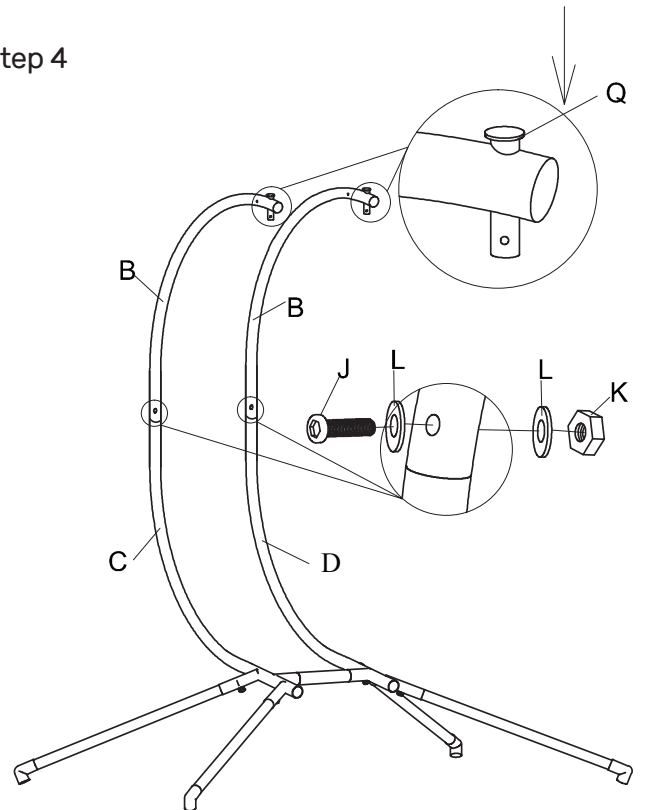

# ASSEMBLY INSTRUCTIONS

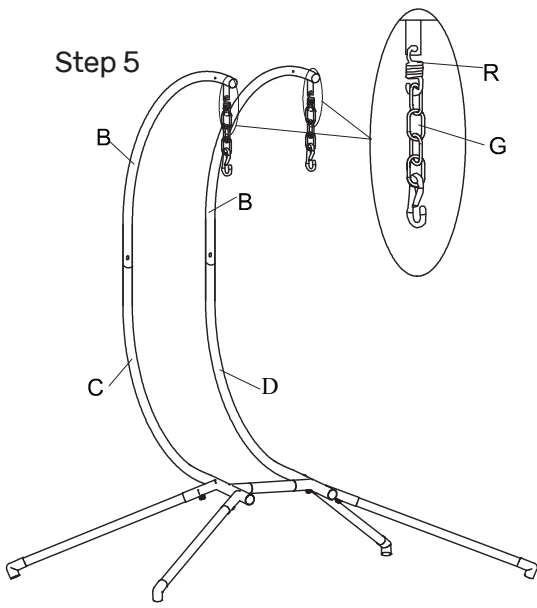

Step 6

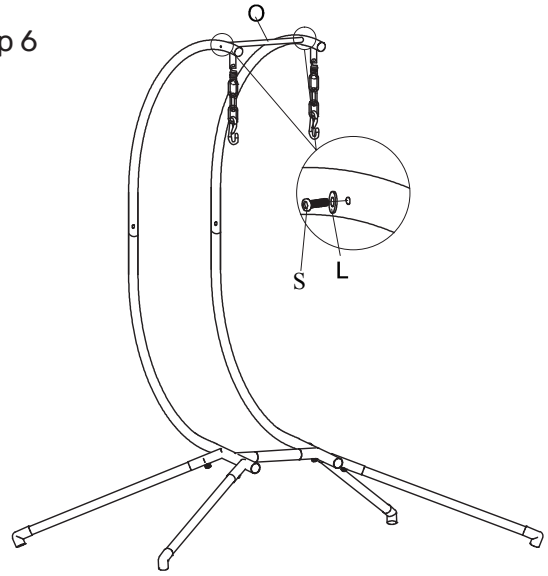

Step 7

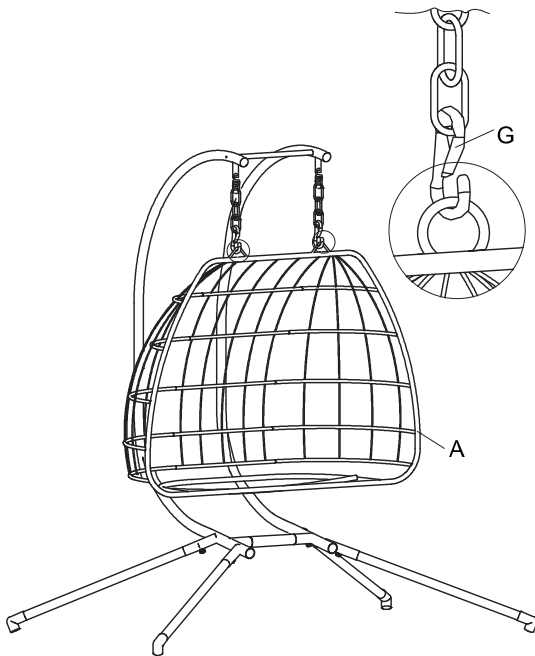

Step 8

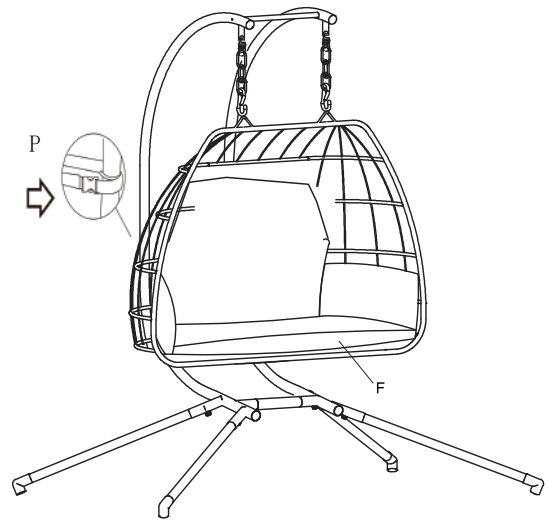

ASSEMBLY COMPLETE