

HOMEBASE

BBQ GAZEBO

INSTRUCTION MANUAL



IMPORTANT: Please read these instructions before using the product and retain for future use.

HHGL Limited, MK9 1BA
HHGL (ROI) Limited, D02 X576

V1_2023

WARNINGS:

- Any assembly or maintenance of the product must be carried out by adults only. We recommend at least 4 adults.
- Do not assemble the gazebo on sandy, muddy or loose soil, as stakes do not have enough anchorage in these types of soil.
- Please check your state and local regulations prior to purchasing. Some jurisdictions may require permits for installation and use. Some special procedures may be valid in your area.
- Install the gazebo on level ground. Stakes are provided to secure the gazebo to the ground.
- If you wish to secure the gazebo to a wood deck or concrete surface, use anchors suited to these surfaces (anchors not included).
- Some parts may contain sharp edges. Wearing protective gloves is advised.
- Keep children and pets away while setting up the gazebo.
- Check all nuts and bolts periodically to ensure they are tightened.
- Do not light any fires under or near the product!
- This gazebo is intended for decorative and sunshade purposes only, and it is not designed to withstand harsh weather, including high winds, rain, and snow.
- It is recommended that the canopy be removed in the winter and during high winds.
- If scratched, please use touch up paint to prevent rusting.

MAINTENANCE:

- Steel components for this gazebo are treated with rust inhibiting paint. However, due to the nature of steel, surface oxidation (rusting) will occur if these protective coatings are scratched. This is not a defect and thus not covered by the warranty.
- To minimize this condition, it is recommended to use care when assembling and handling the product to prevent scratching the paint. Should any scratching or damage occur, it is recommended to cover the scratch immediately with rust inhibiting paint (not included).
- Do not use bleach, acid, or other abrasive cleaners on the roof or frame parts.
- Do not use a pressure washer.
- Keep the original packaging to store the gazebo.
- Periodically check and ensure that all bolts are well-tighten during use.
- If the product will not be used for a long period of time (e.g. winter time), it should be disassembled and stored in a clean, dry environment.

ASSEMBLY INSTRUCTIONS:





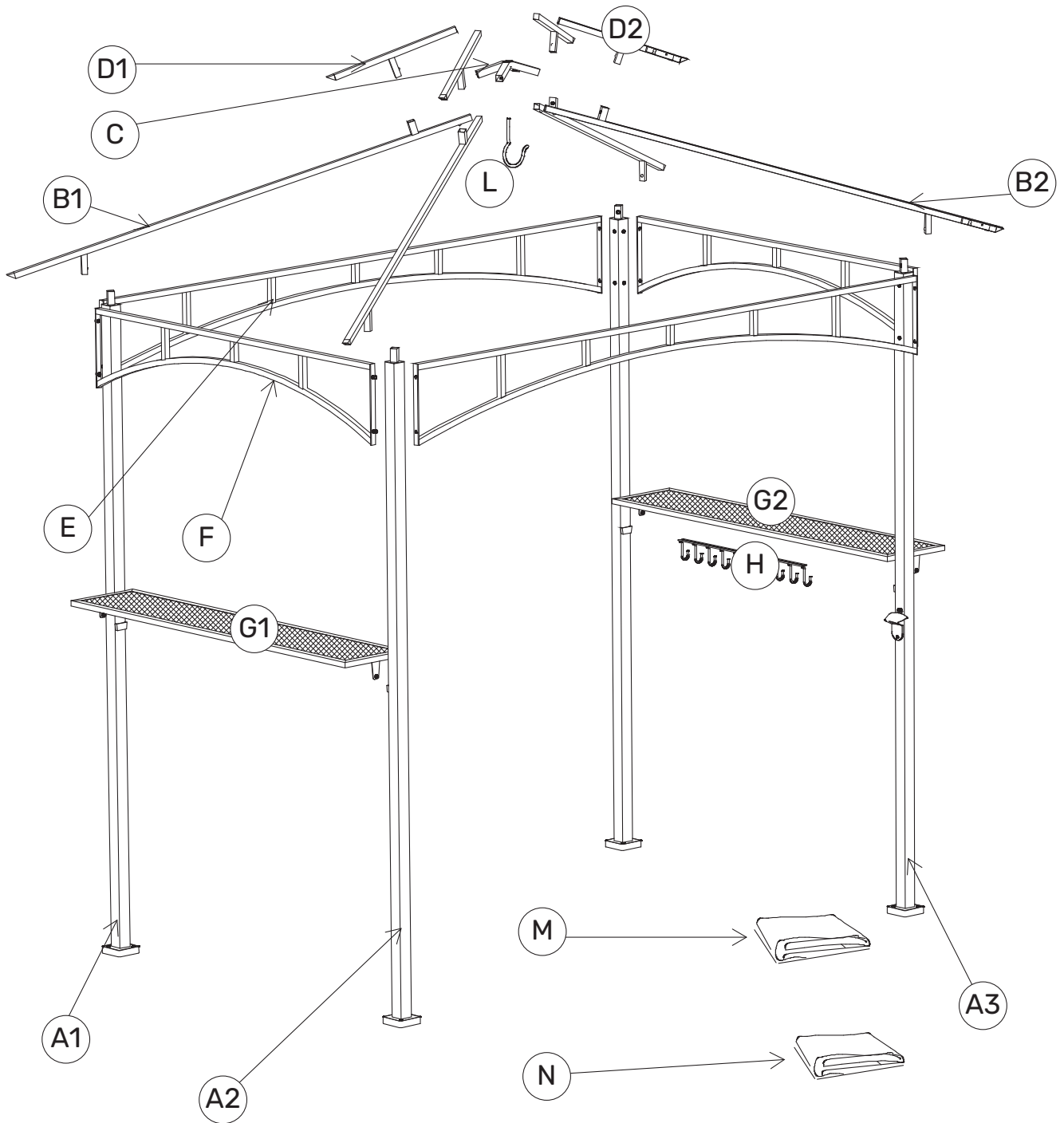





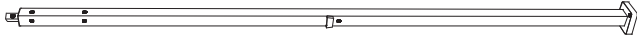

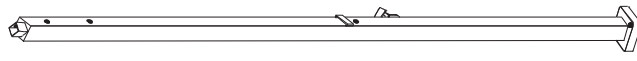

Please check you have all the components and fittings listed.

If you find any missing or damaged parts, please contact our customer services team on 0333 003 7084 between 09:00 & 18:00, or use the contact form on our website www.homebase.co.uk

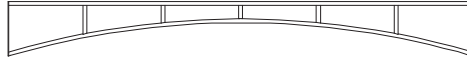

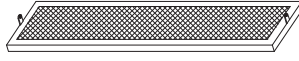
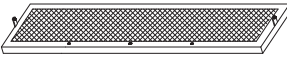

ASSEMBLY INSTRUCTIONS:

Parts:

Label	Part Number	Description	Part Image	Qty
A1	P000200335	Pole (1)		x 1
A2	P000200336	Pole (2)		x 2
A3	P000200337	Pole (3)		x 1
B1	P000601055	Big beam (1)		x 3
B2	P000603166	Big beam (2)		x 1
C	P000500850	Big connector		x 1
D1	P000601054	Small beam (1)		x 3
D2	P000603167	Small beam (2)		x 1
E	P000400704	Long screen		x 2
F	P000400705	Short screen		x 2
G1	P002100609	Panel 1		x 1
G2	P002100610	Panel 2		x 1
H	P005800142	Hook rack		x 1
M	P001100756	Big canopy		x 1
N	P001100755	Small canopy		x 1
L	P005800001	Hook		x 1

Fittings:

Label	Part Number	Description	Part Image	Qty
H1	H990040002	Bolt 1		x 20+2
H2	H990040003	Bolt 2		x 3+1
HR	H070010001	Φ6×230 mm Stake		x 8

Step 1

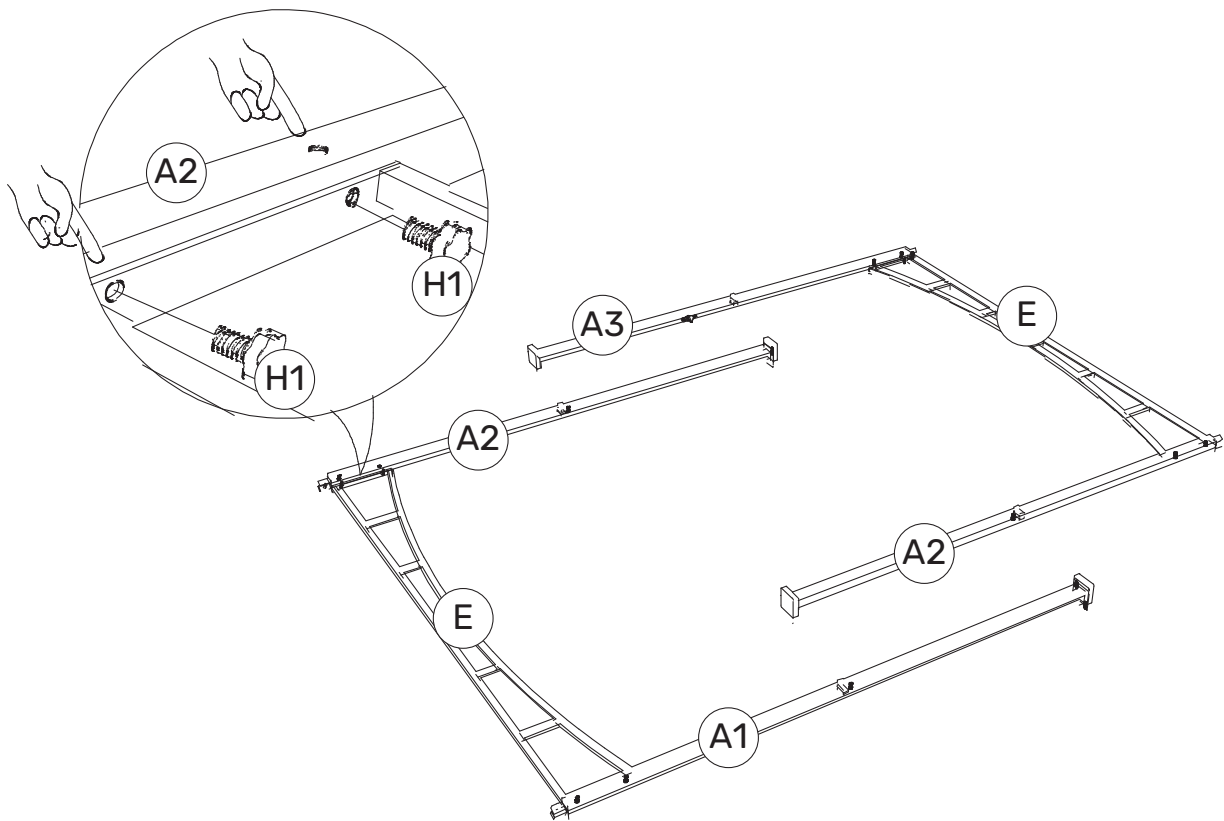
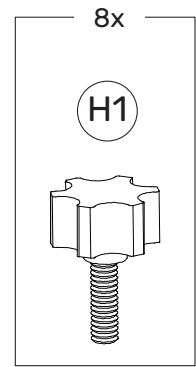
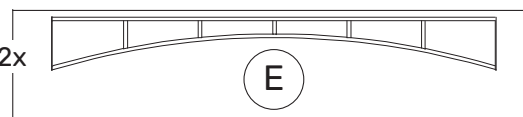
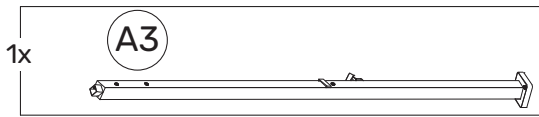
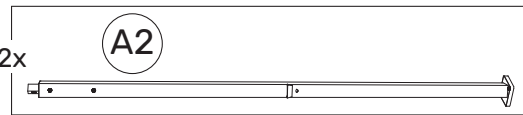
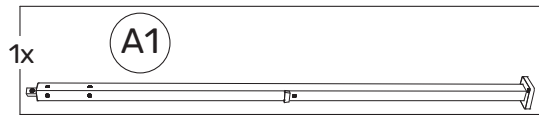

Step 2

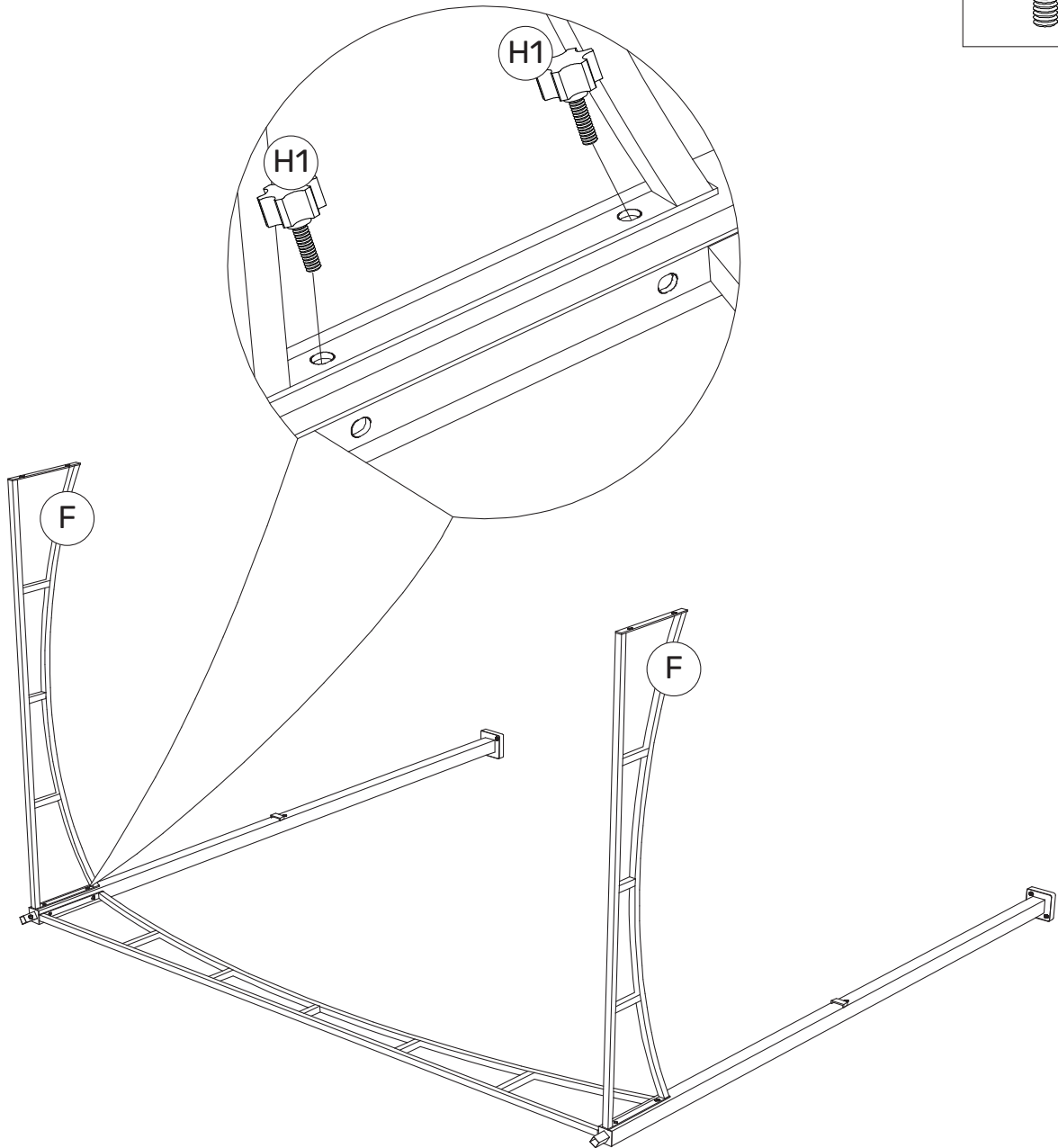
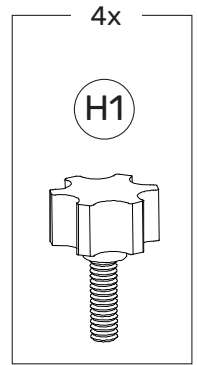
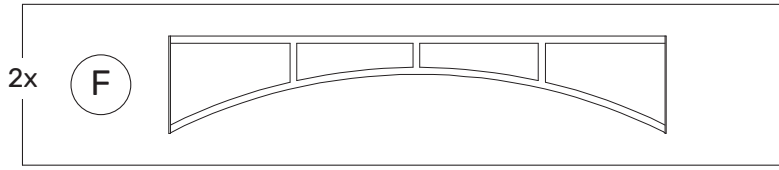

Step 3

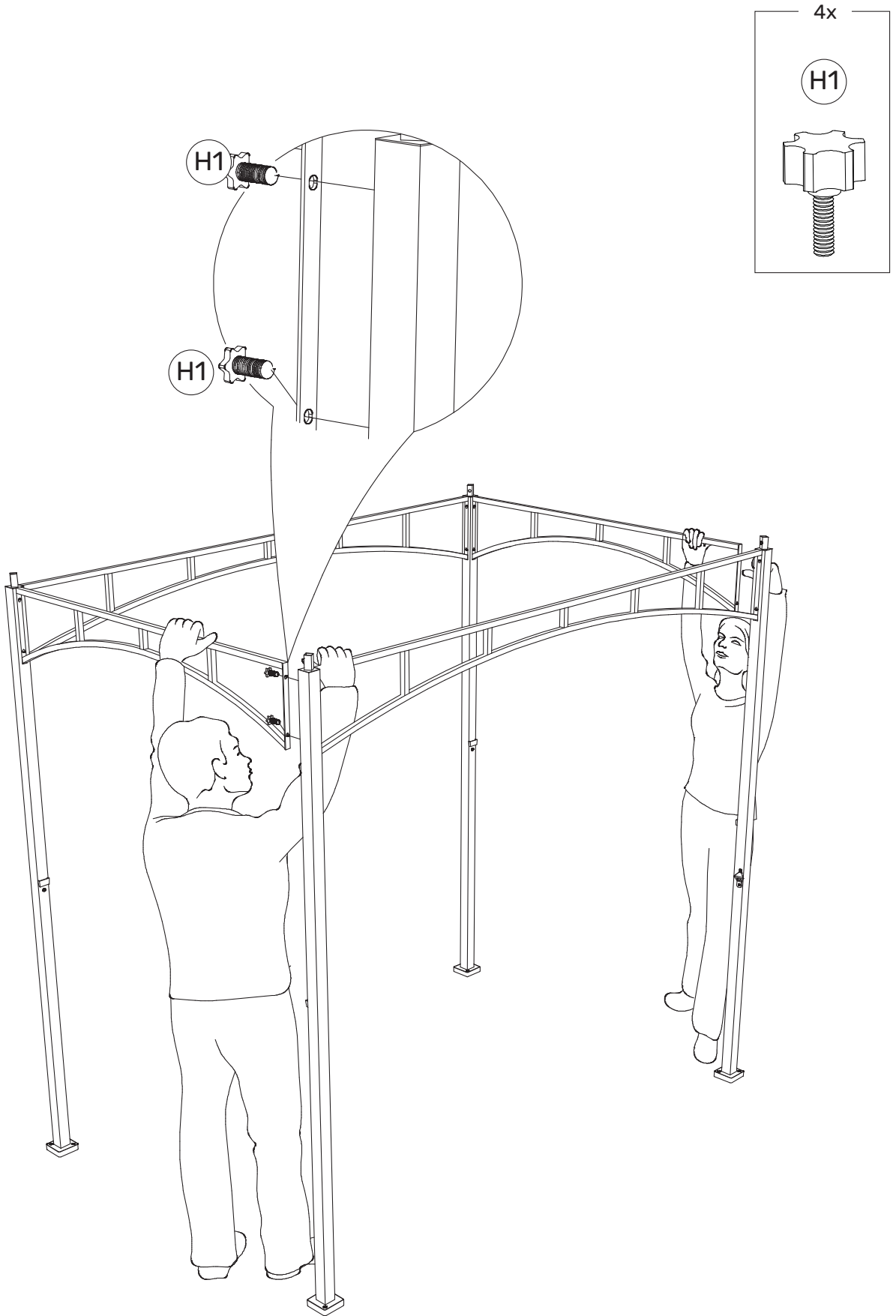

Step 4

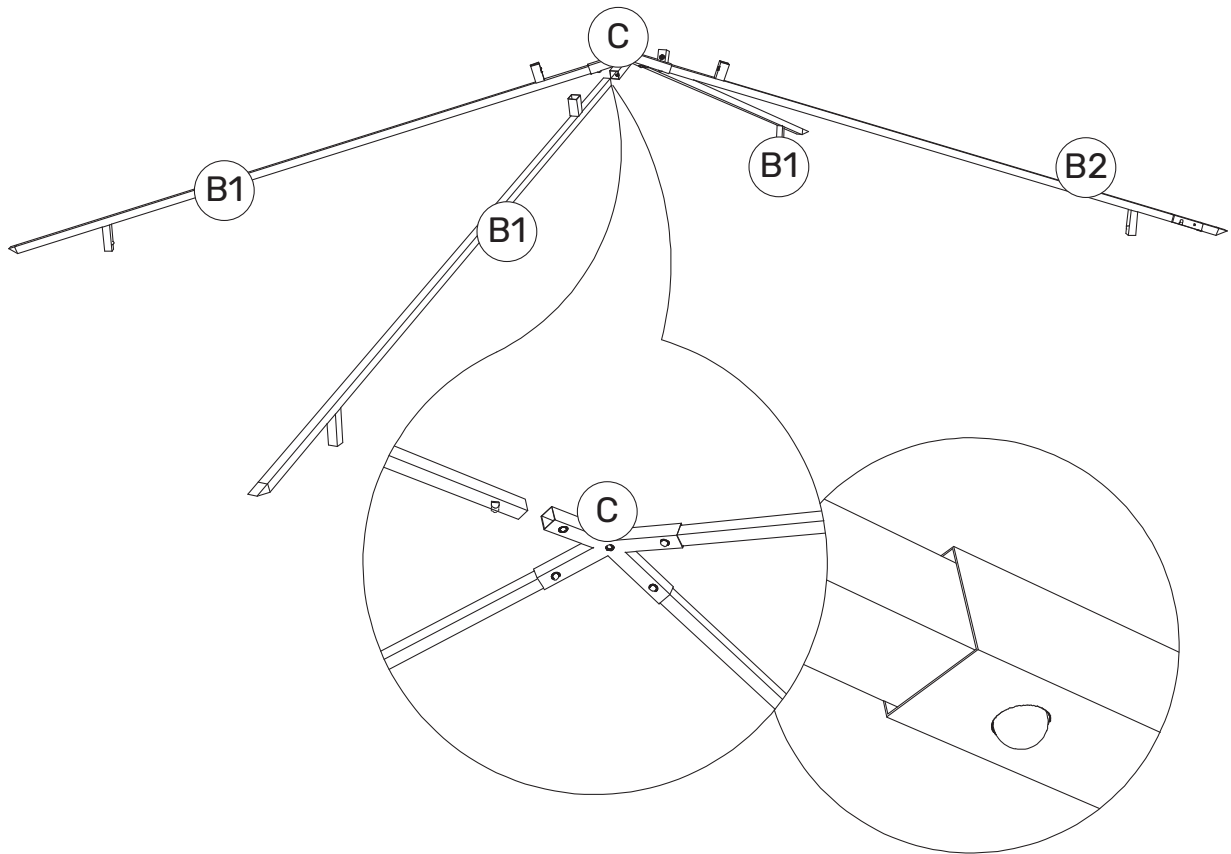
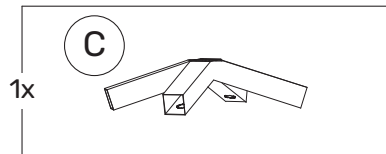
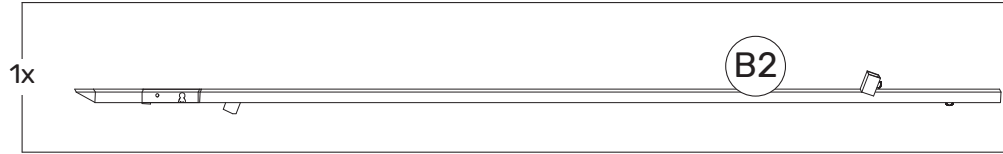
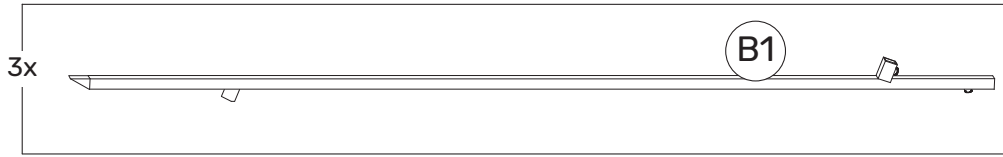

Step 5

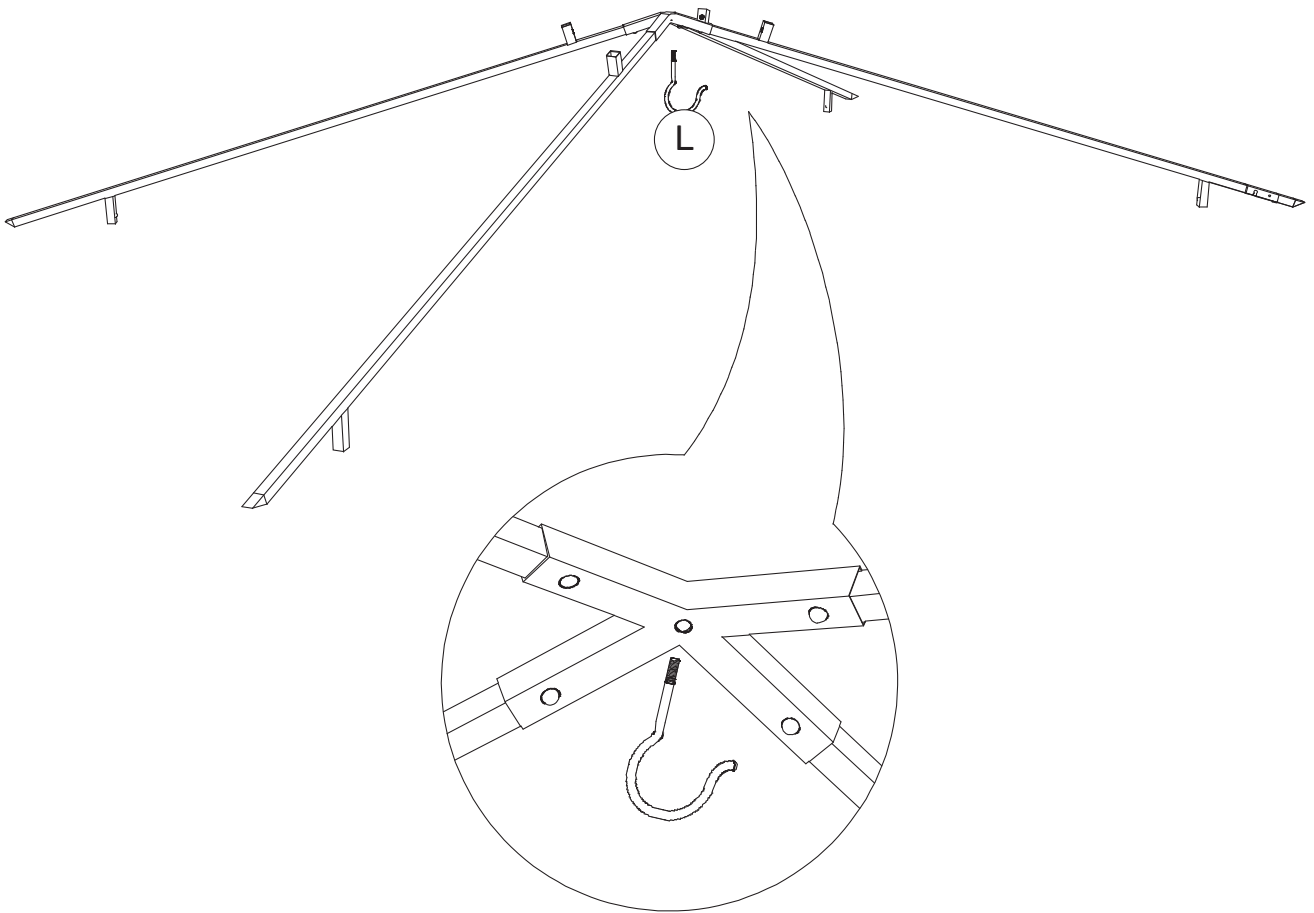
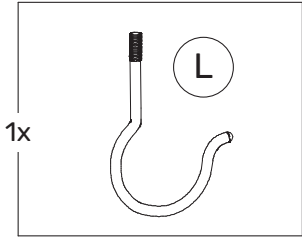

Step 6

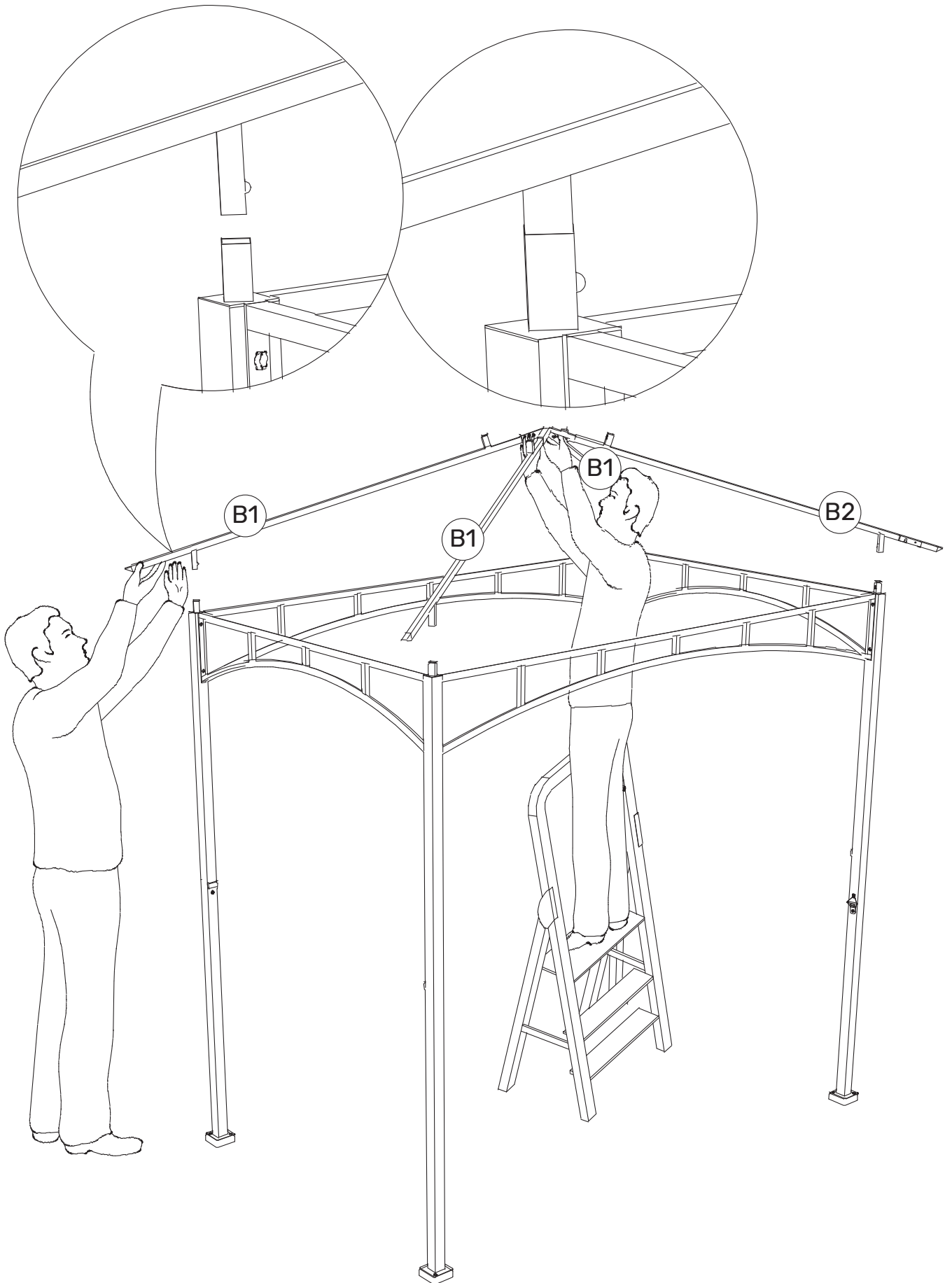

Step 7

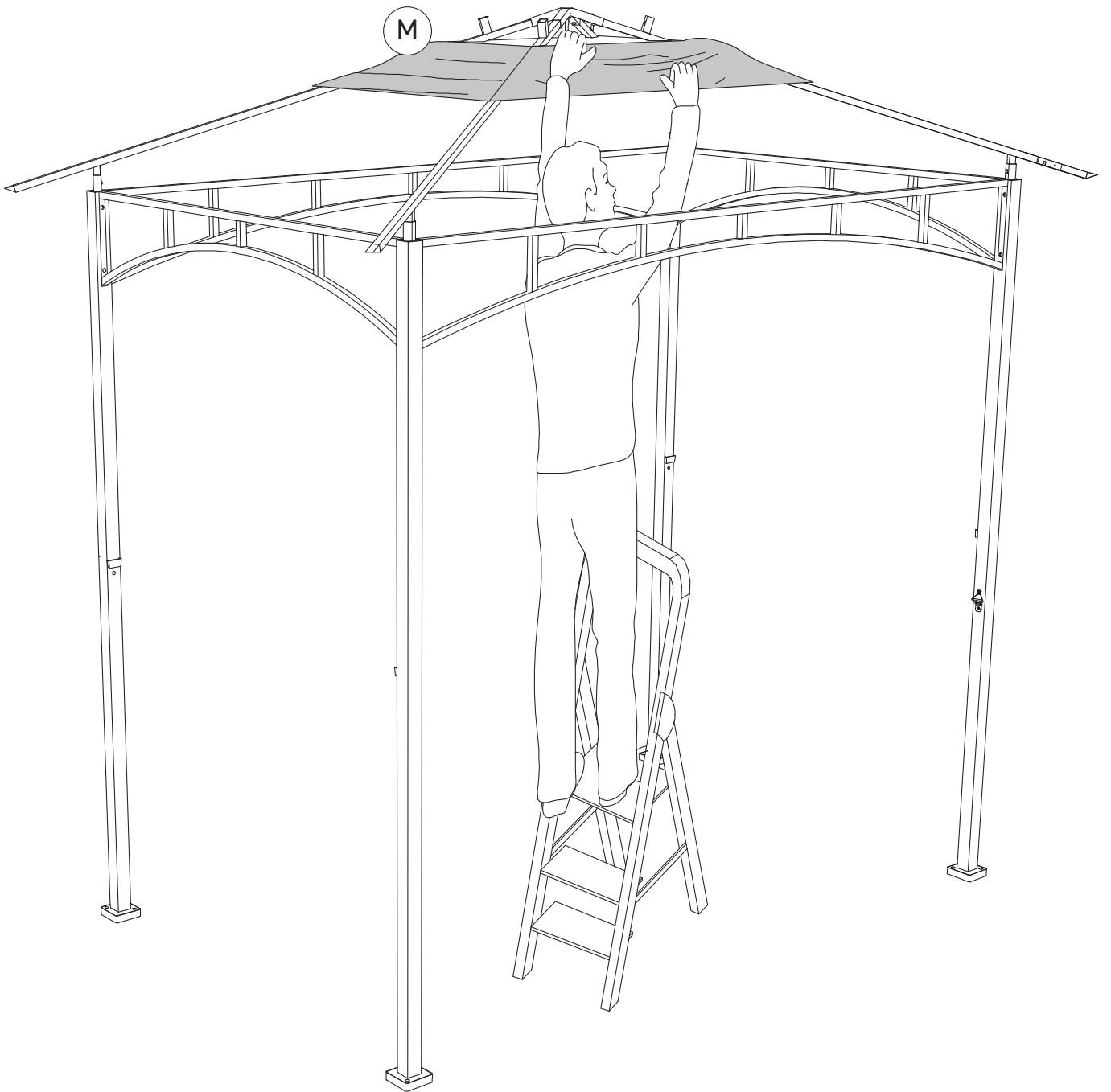
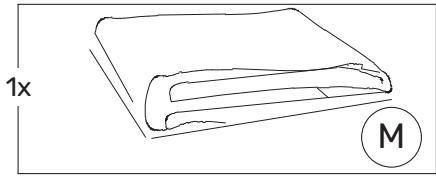

Step 8

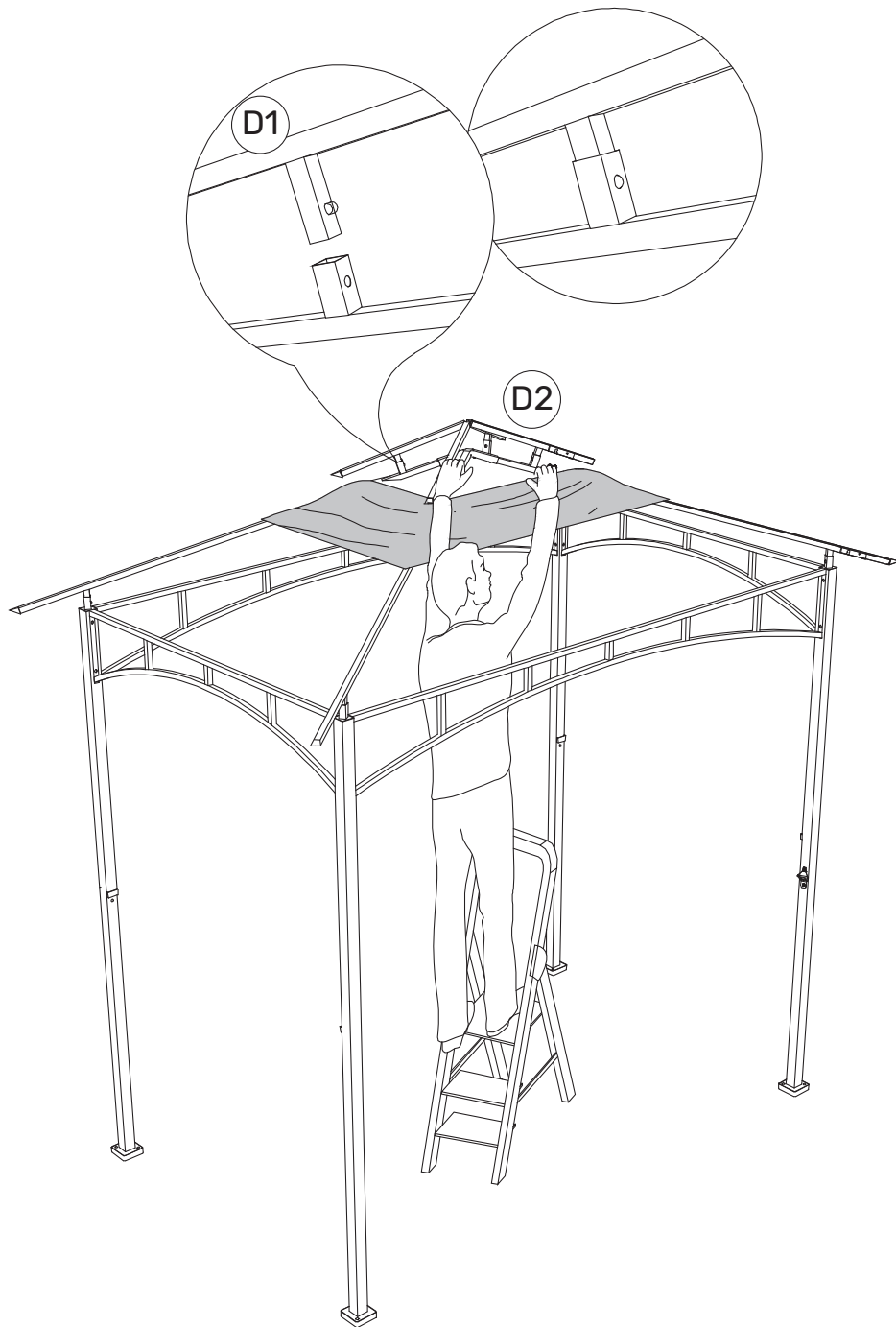
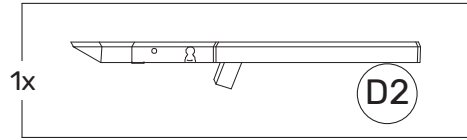
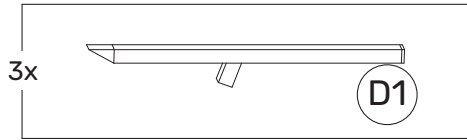

Step 9

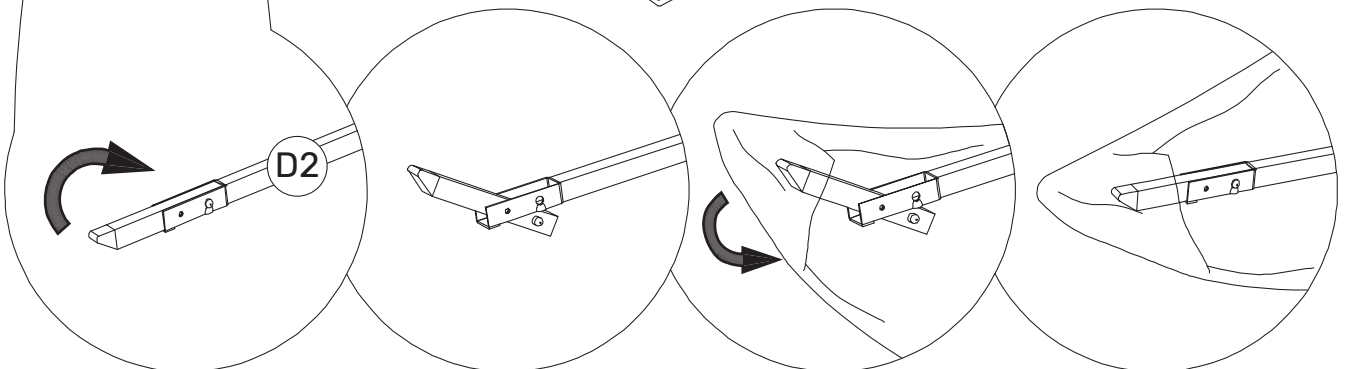
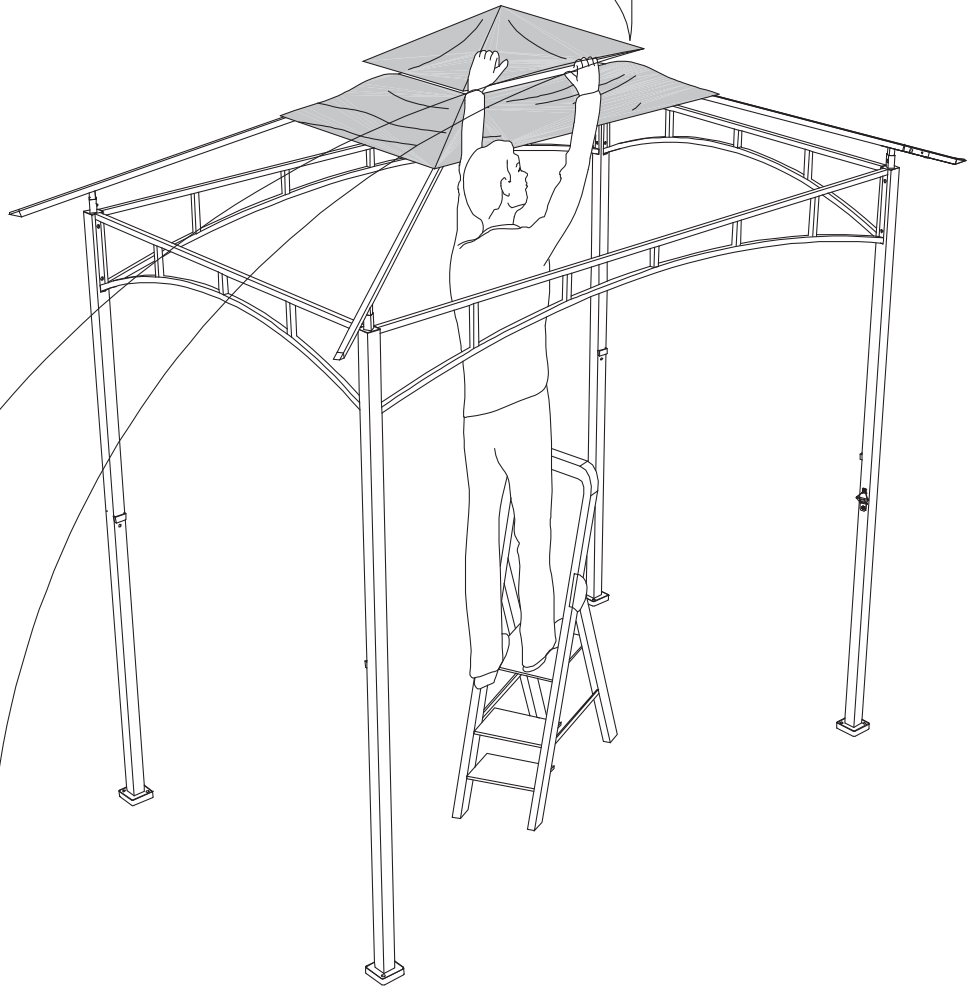
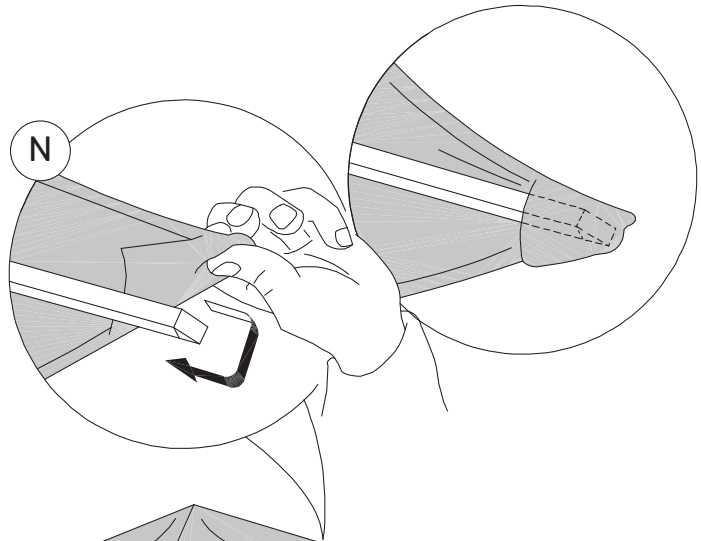
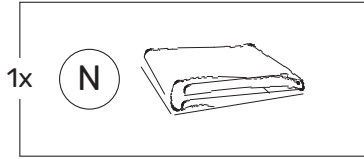

Step 10

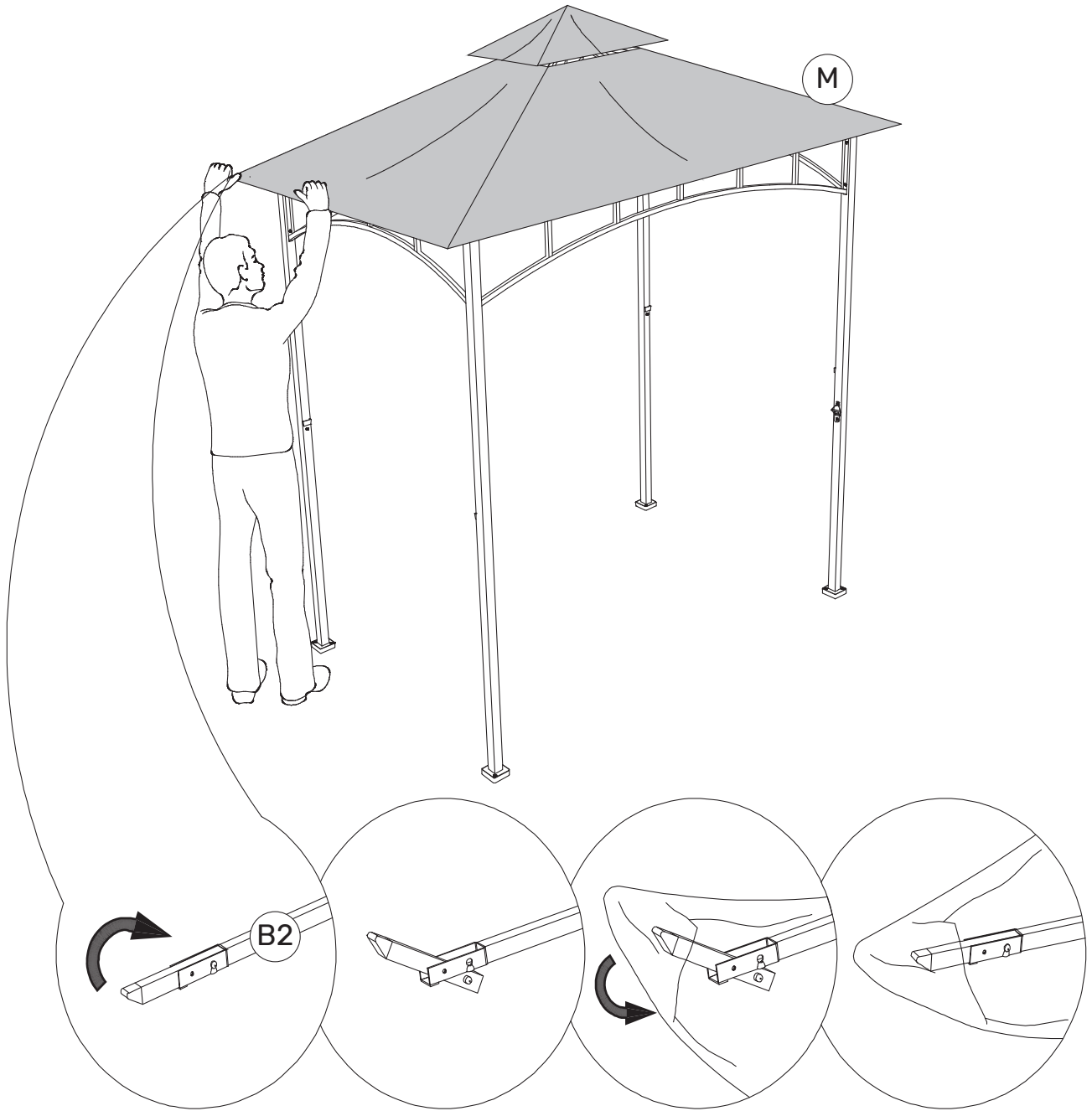

Step 11

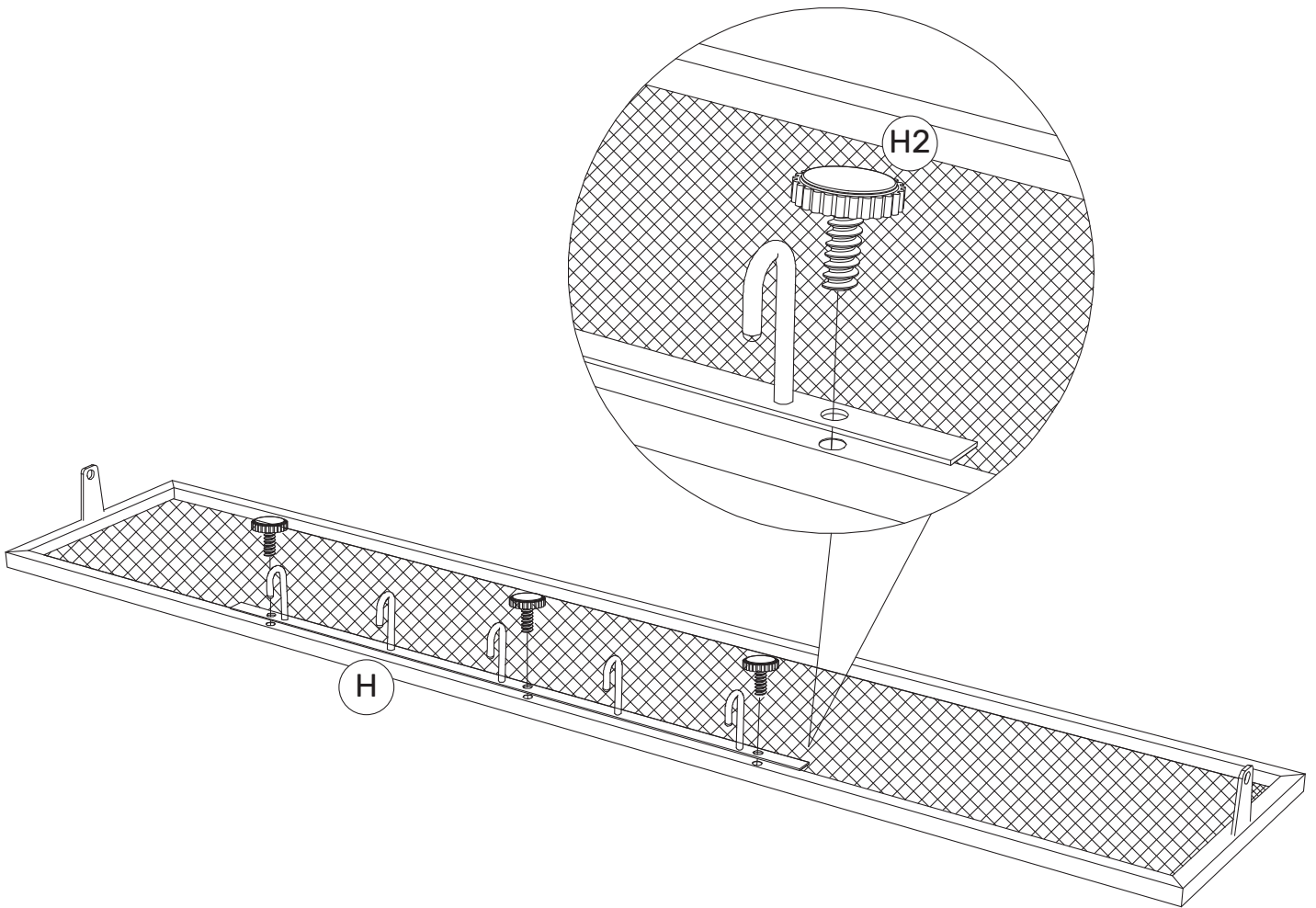
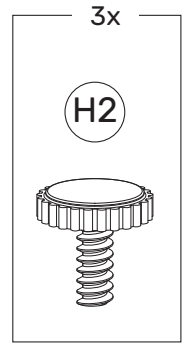
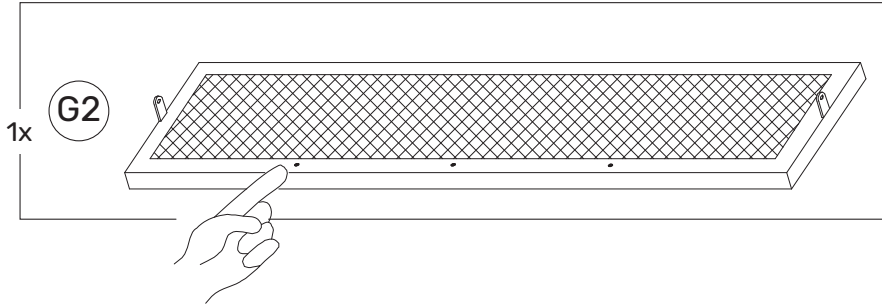
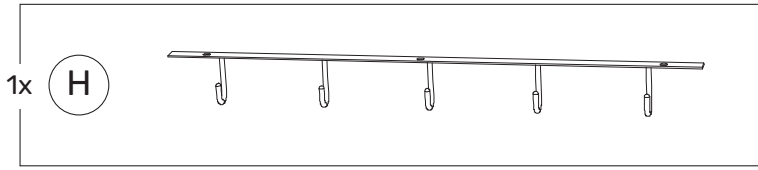

Step 12

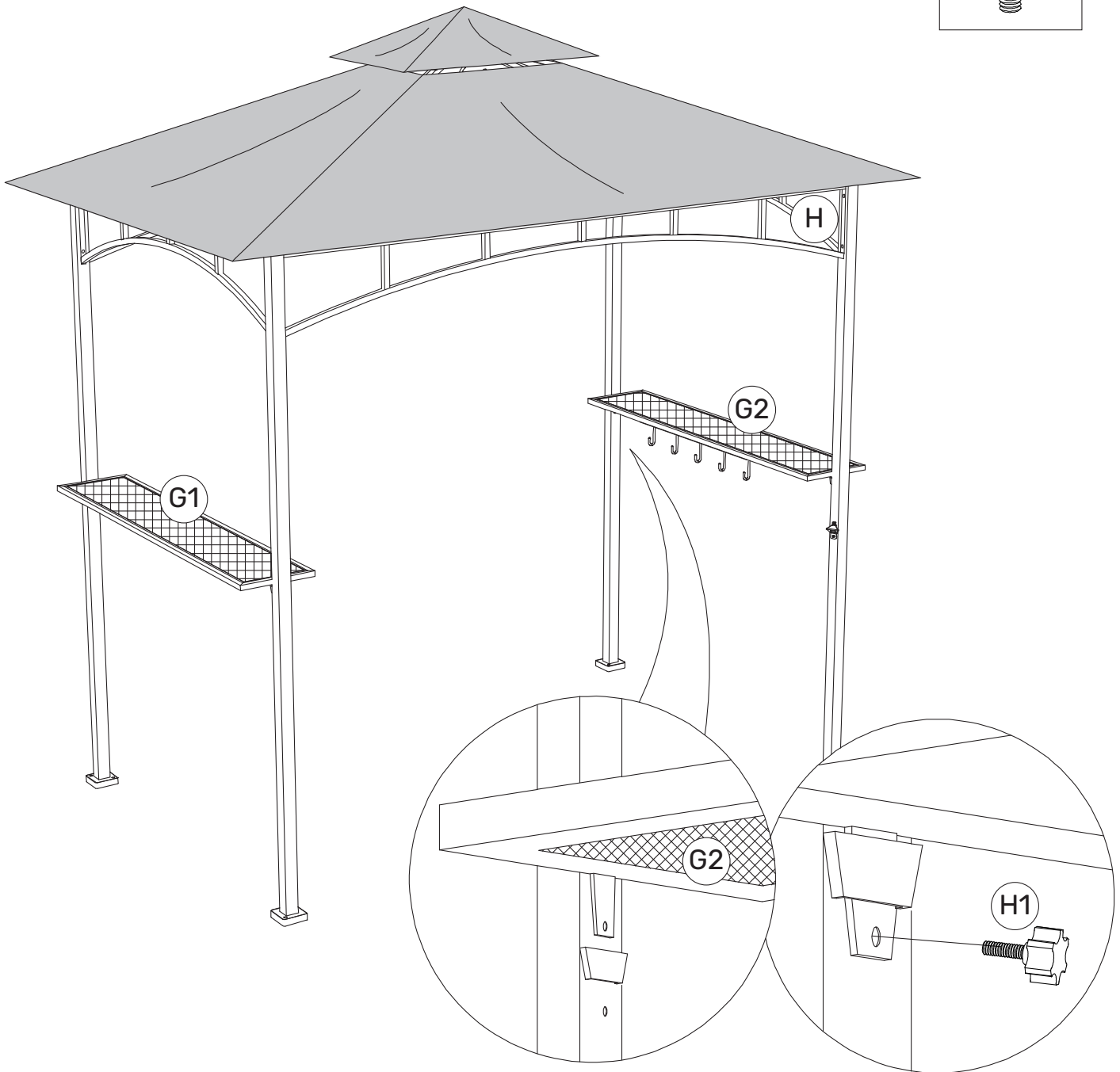
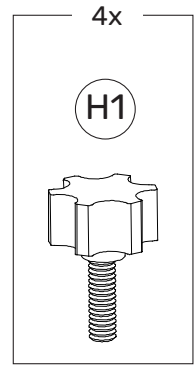
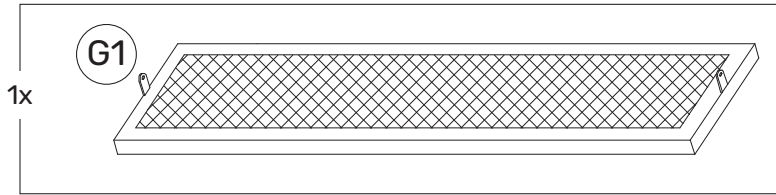

THE USE OF POWER TOOLS TO ASSEMBLE THIS PRODUCT WILL INVALIDATE ANY WARRANTY, AND MAY DAMAGE THIS PRODUCT MAKING IT UNSAFE.

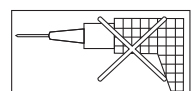

Step 13

