

HOMEBASE

MADISON TALL UNIT - 1600 x 350 x 300MM

INSTRUCTION MANUAL

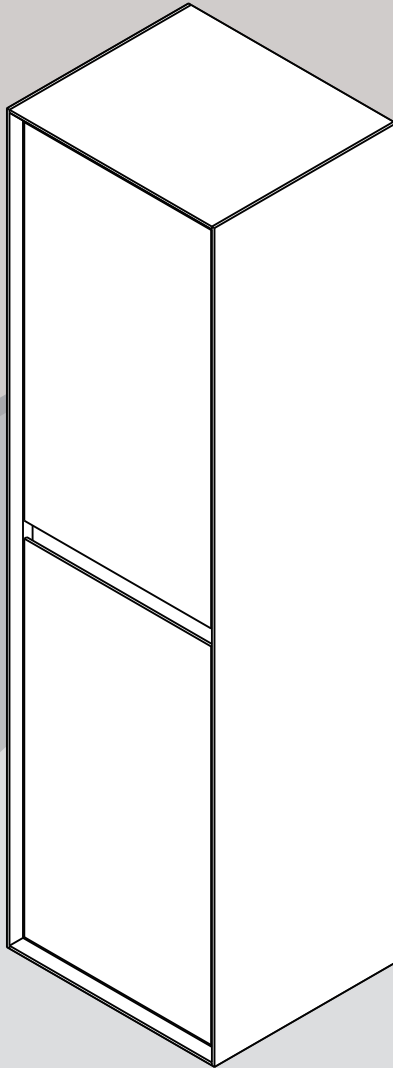

IMPORTANT: Please read these instructions before
using the product and retain for future use.

HHGL Limited, MK9 1BA
HHGL (ROI) Limited, D02 X576

INSTALLATION

PRE-INSTALLATION CHECKS

- 1) Check that the furniture is compatible with your current layout requirements.
- 2) Before installing the furniture, please make sure you have received all items and that they are undamaged. Any damage claims after installation will not be accepted.
- 3) Check that the floor and wall are level and perpendicular.









INSTALLATION ADVICE

- 1) Water must be turned off at the mains supply before you begin installation.
Pipe installation must comply with all local regulations regarding plumbing and other specific requirements.
- 2) Lay the furniture on a soft surface to avoid any damage, such as scuffs or scratches, and inspect, as any fault reported after this stage will not be accepted.

CARE INSTRUCTIONS

- 1) Use a mild detergent, such as liquid soap and warm water for cleaning. Do not use abrasive cleaners that may scratch or dull the surface.
- 2) Carefully read the cleaning product label to ensure the cleaner is safe for use on the material.
- 3) Wipe surface and rinse completely after cleaning application. Rinse and dry any overspray that lands on nearby surfaces.
- 4) Use a soft, dampened sponge or cloth; never use an abrasive material, such as a brush or scourer.
- 5) Maintain good ventilation in the bathroom, keeping the air flowing as much as possible.







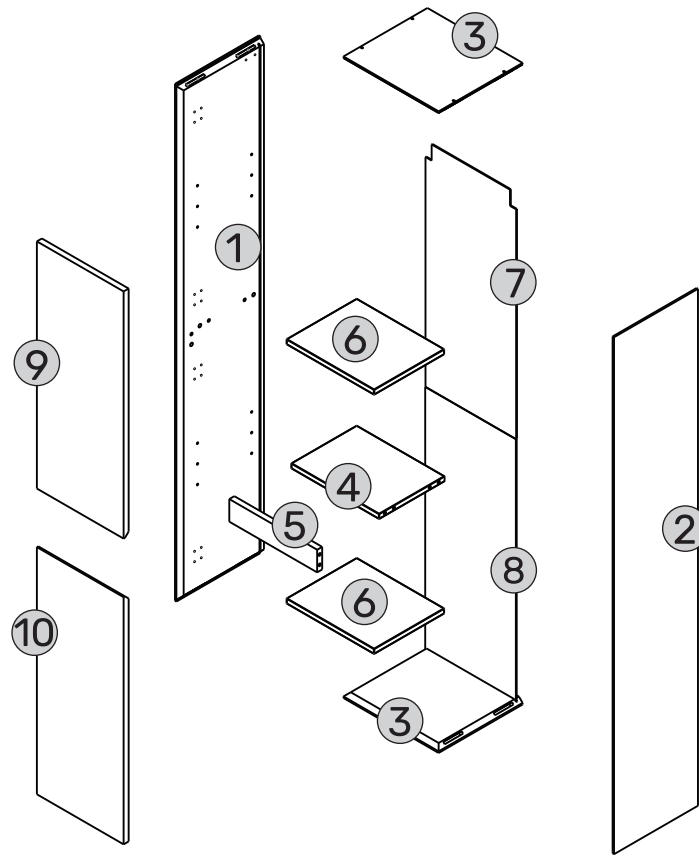



TOOLS REQUIRED (NOT INCLUDED)

	Screwdriver	x 1		Electric drill	x 1
	Spanner	x 1		Spirit level	x 1
	Tape measure	x 1		Pencil	x 1
	Hammer	x 1	 $\phi 8$	Drill bit	x 1

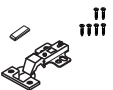
PARTS LIST - COMPONENTS

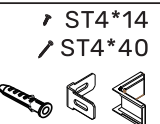
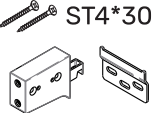

PARTS LIST - FIXINGS

No.	Description	Qty	No.	Description	Qty
A	Cam studs 	6	B	Locking cams 	6
C	Covers 	14	D	Wooden dowels 	6
E	Hinges 	4	F	Shelf supports 	8
G	Expansion tube & screws  5*40	4	H	Fixing support  ST4*14 ST4*40	1
I	Hangers  ST4*30	2	J	Fixing supports  ST3*14	8
K	Door bumper sets 	2	L	Assembling supports  L1 L2	8
M	Allen key 	1			

ASSEMBLY INSTRUCTIONS

Step 1

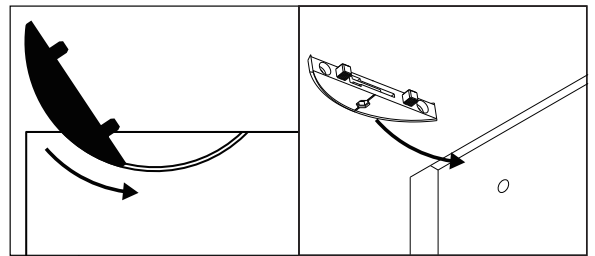
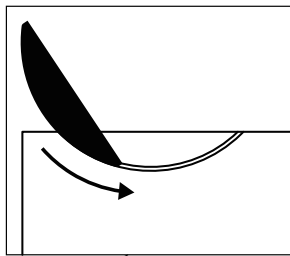
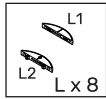

Attention: Accessory holes and plate holes should be in the same direction.

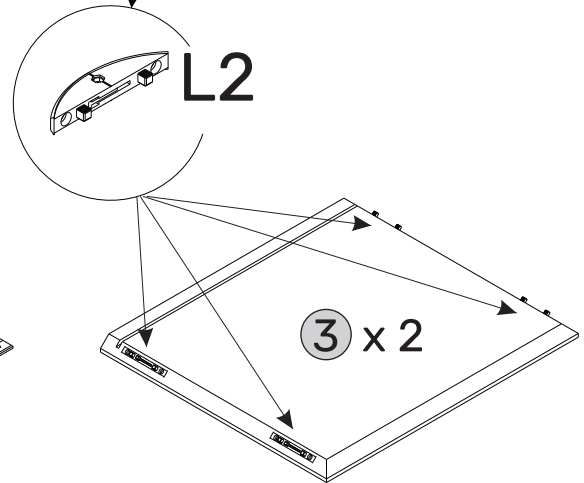
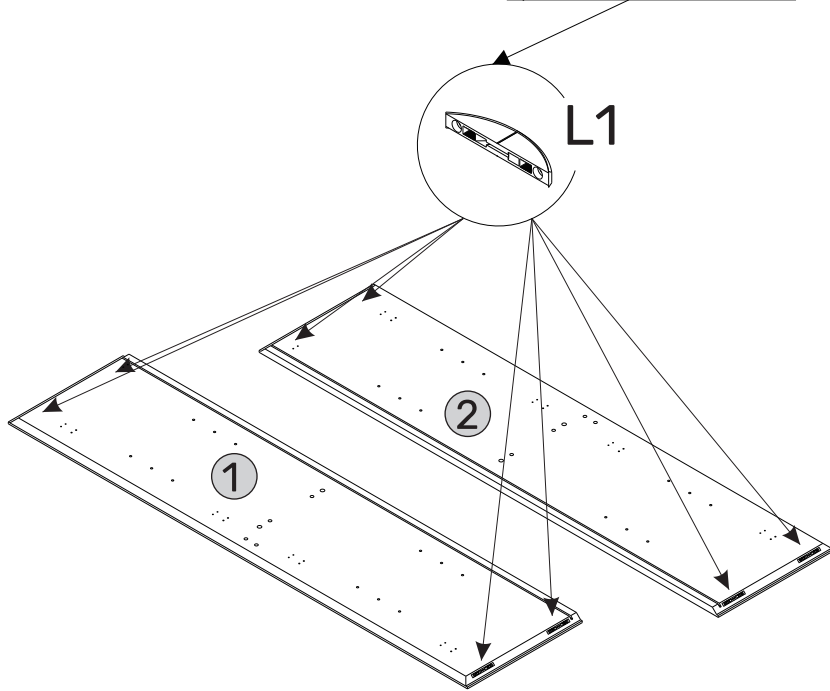

Insert L1 into panel 1 and panel 2. Insert L2 into panel 3.

Step 2

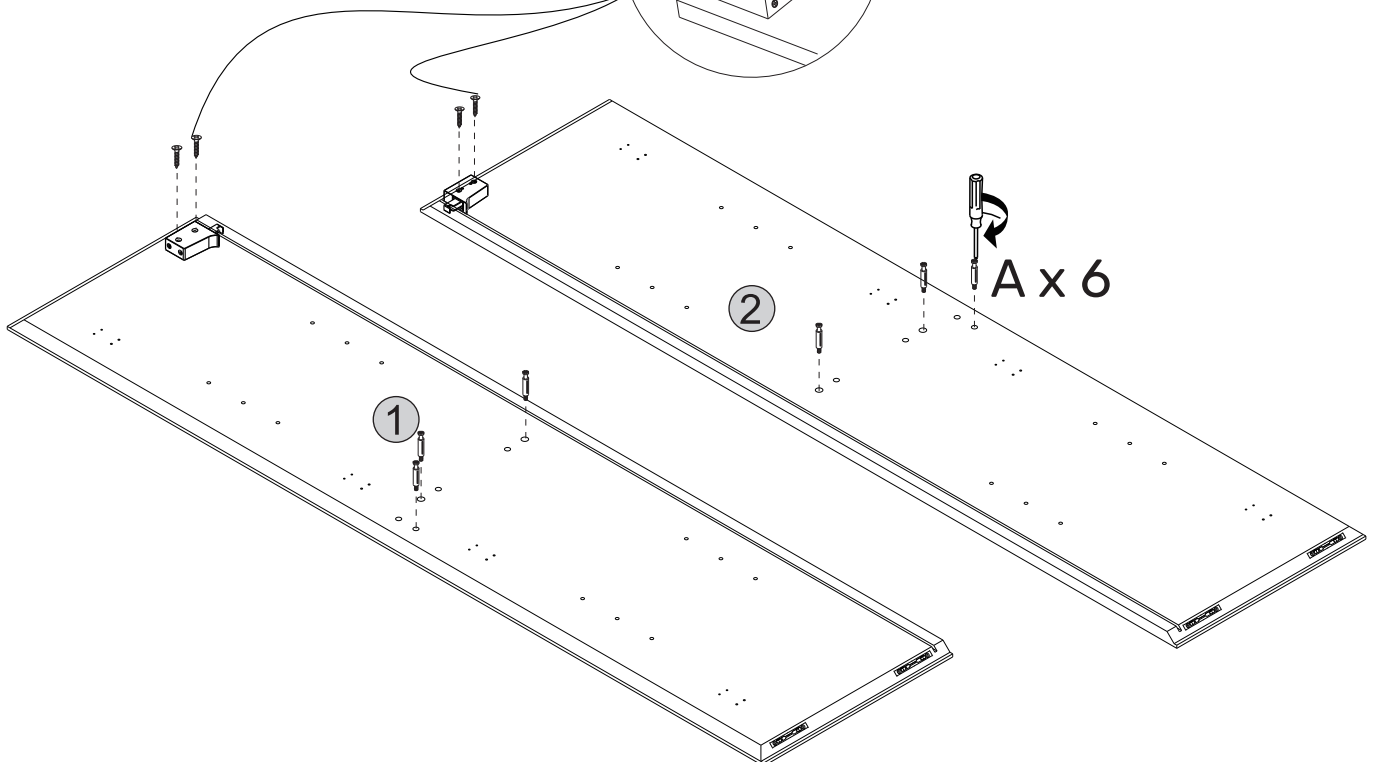
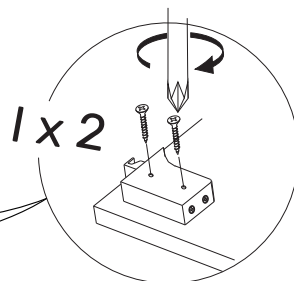
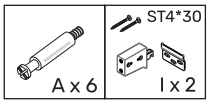

Insert A into panels 1 and 2.

Assemble part of hanger I on panels 1 and 2, using ST4*30 screws.

Step 3

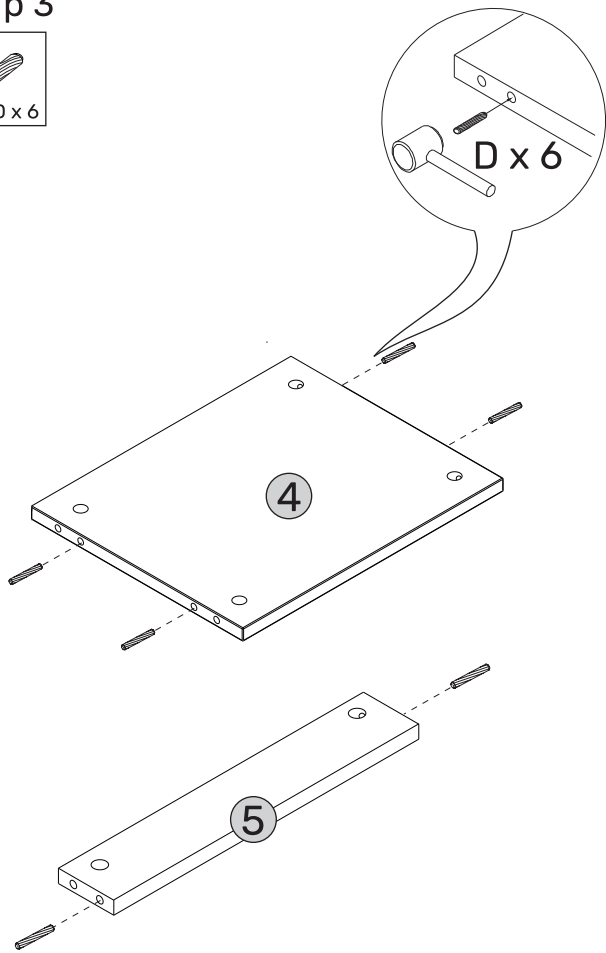

Step 4

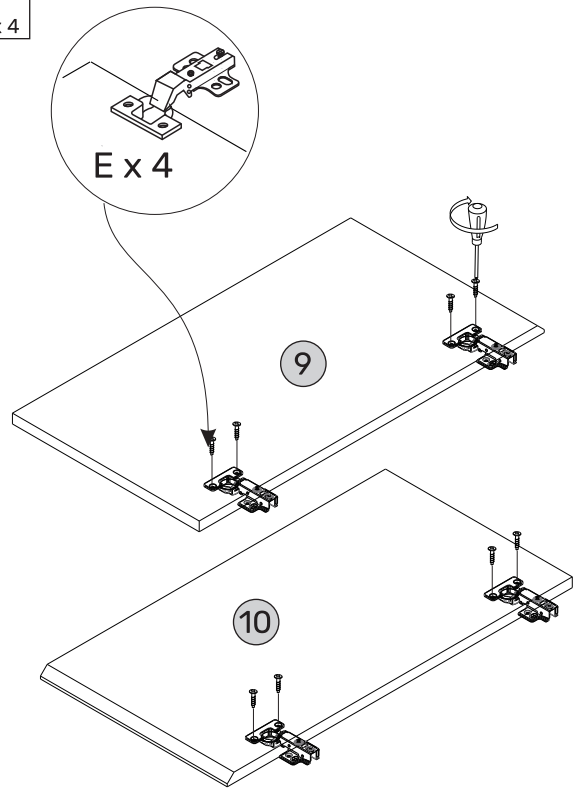
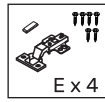

Insert wooden dowels D into panels 4 and 5.

Assemble hinges E onto panels 9 and 10.

Step 5

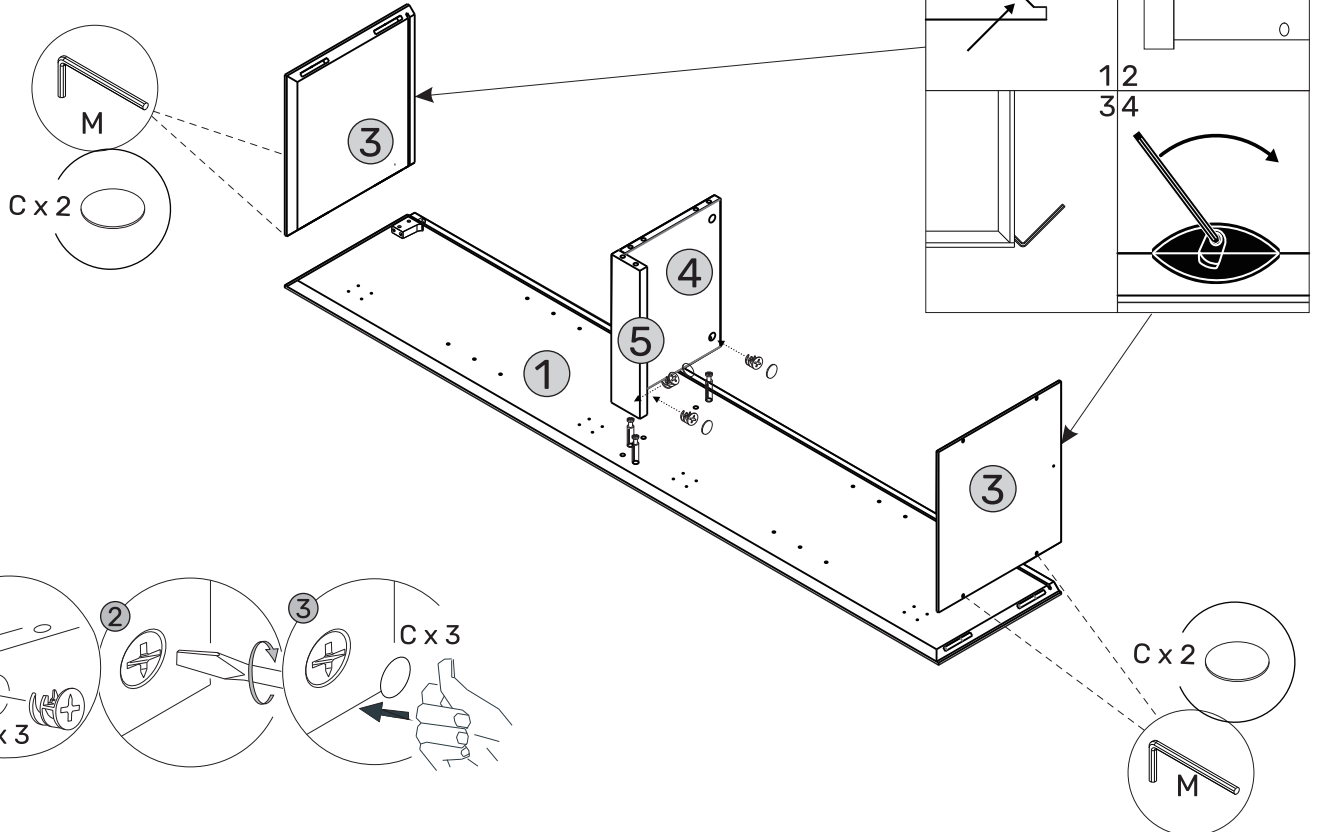
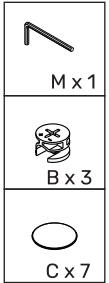

Connect panel 3 to panel 1, using Allen Key M. Attach panels 5 and 4 onto panel 1 and fix in place using B. Then place cover C on top of B.

Step 6

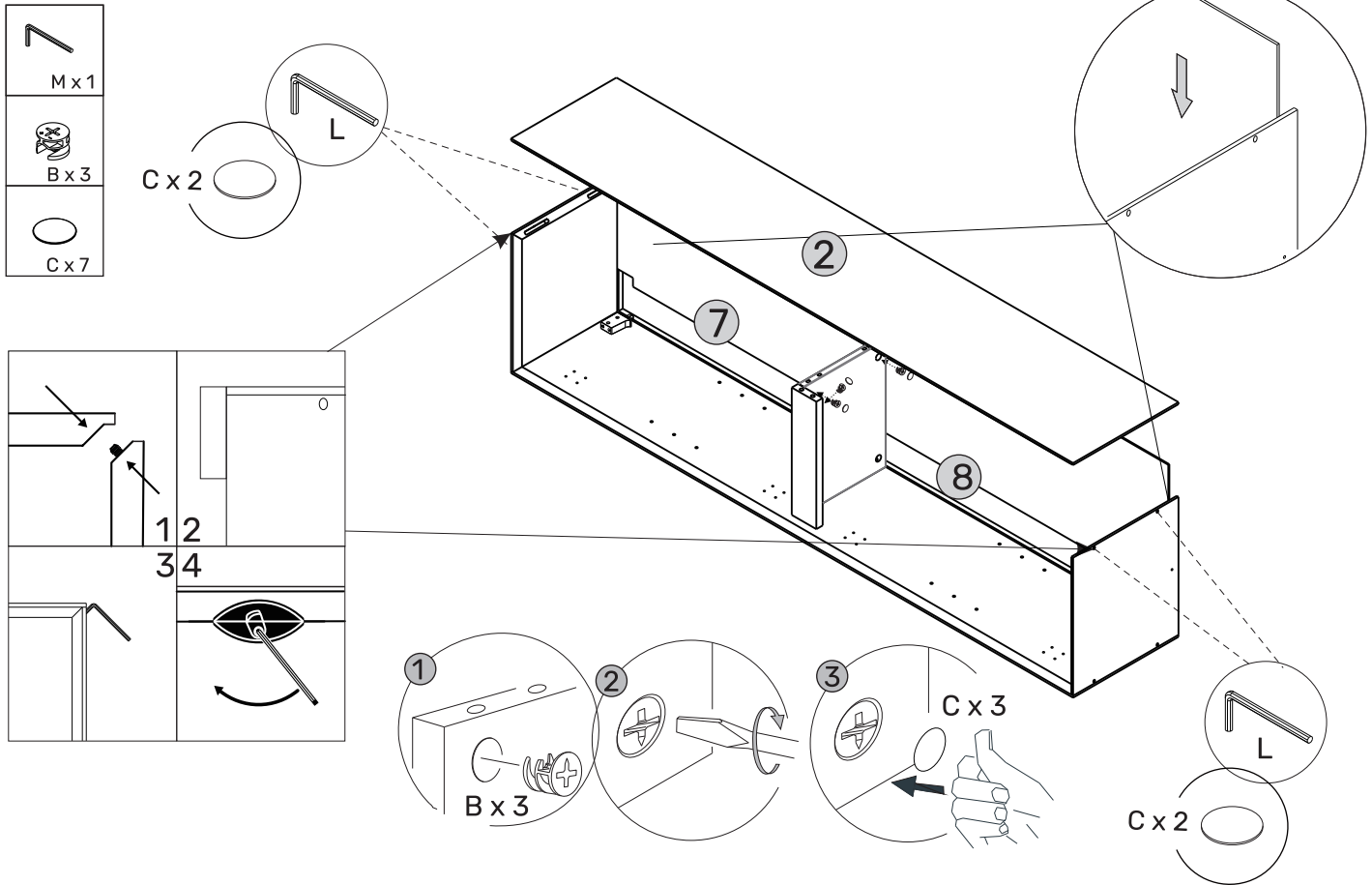

Connect panel 2 to panels 3, 4 and 5 using Allen Key M. Fix together tightly with B and place cover C on top of B.

Step 7

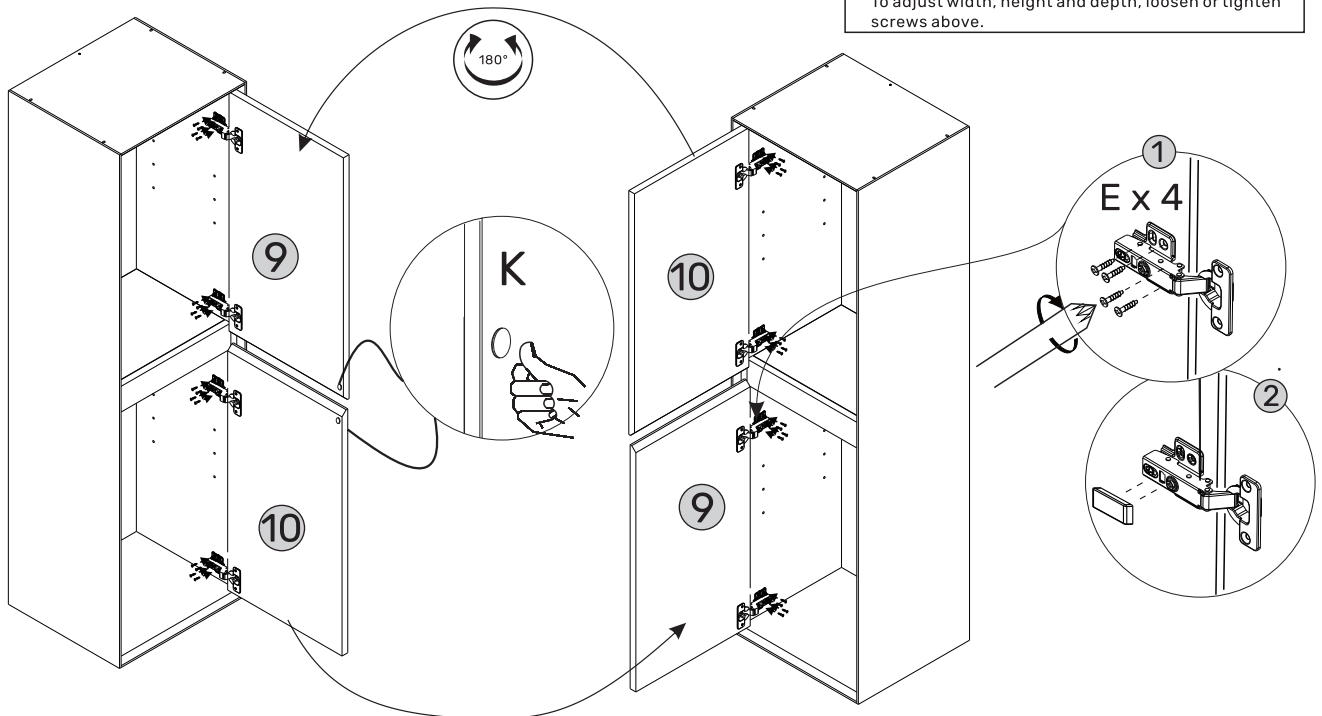
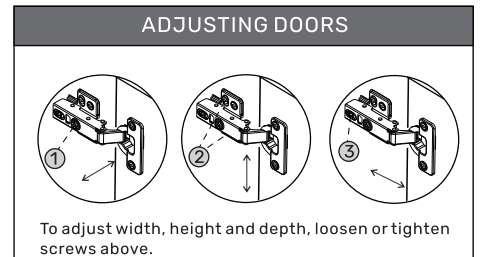
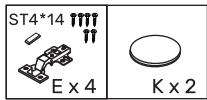

Attach panels 9 and 10 onto side panel 1 or 2 (depending on which way you want the door to open). Adjust the hinges as shown. Affix K on the corner of the door.

Step 8

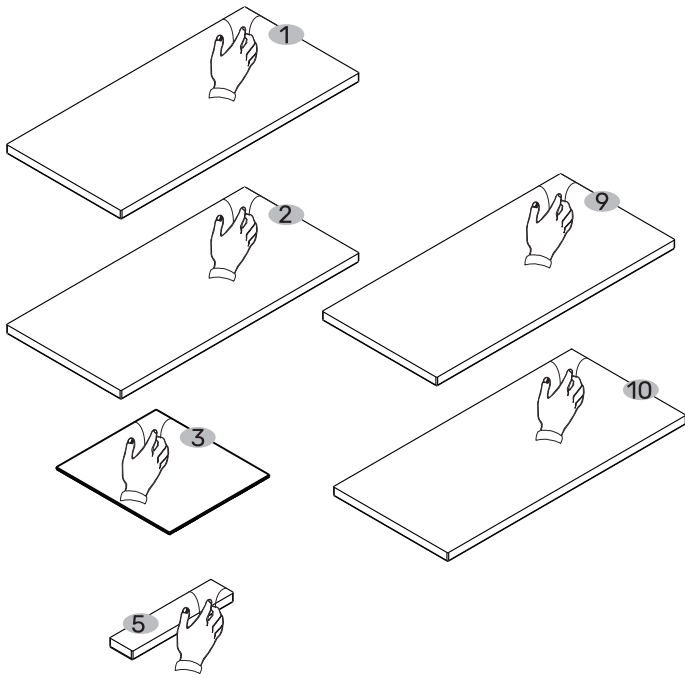

Remove protective film from components (applies to 656059 model only).

FIXING TO THE WALL

Step 1

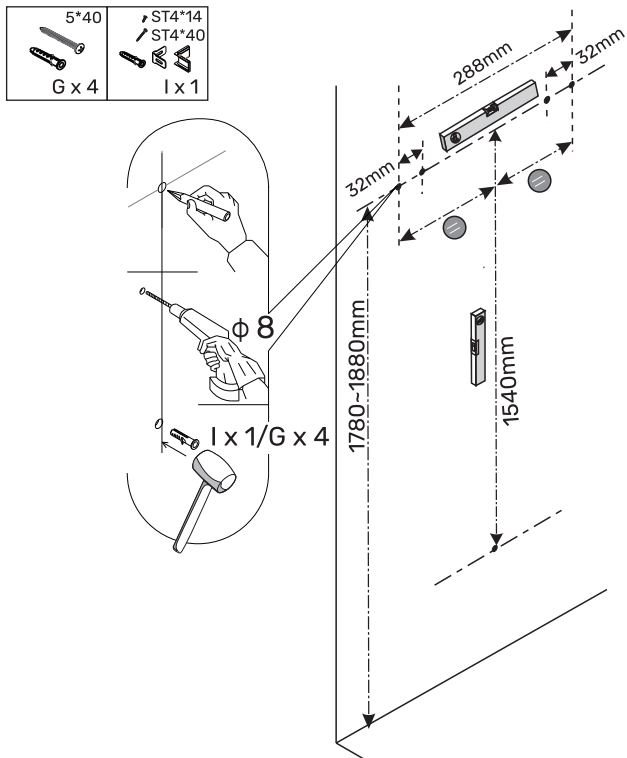

Measure the mounting hole distance of the cabinet, as shown. Mark the installation position on the wall with a pencil and keep it level. Drill holes and insert expansion tubes into the wall.

Step 9

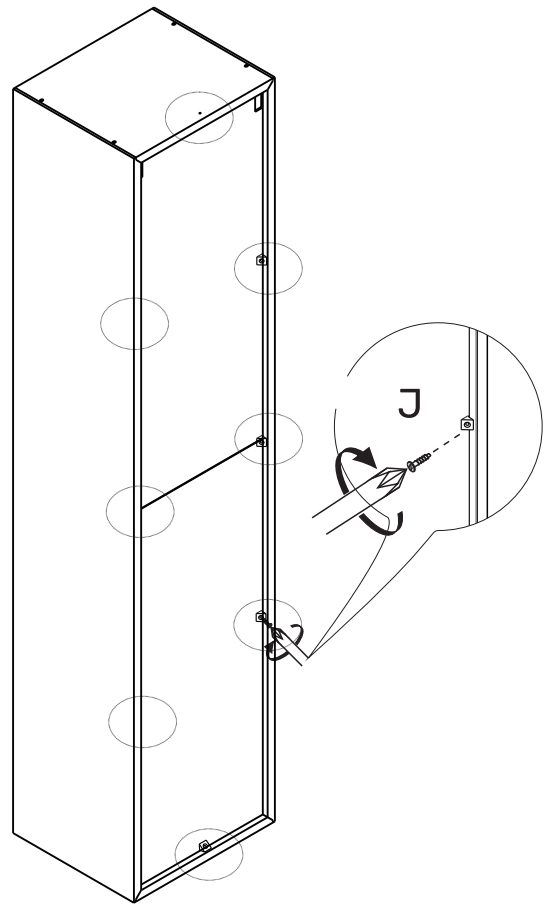
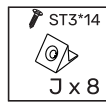

Fix the back panels onto panels 1, 2 and 3, using bracket J with screws ST3*14.

Step 2

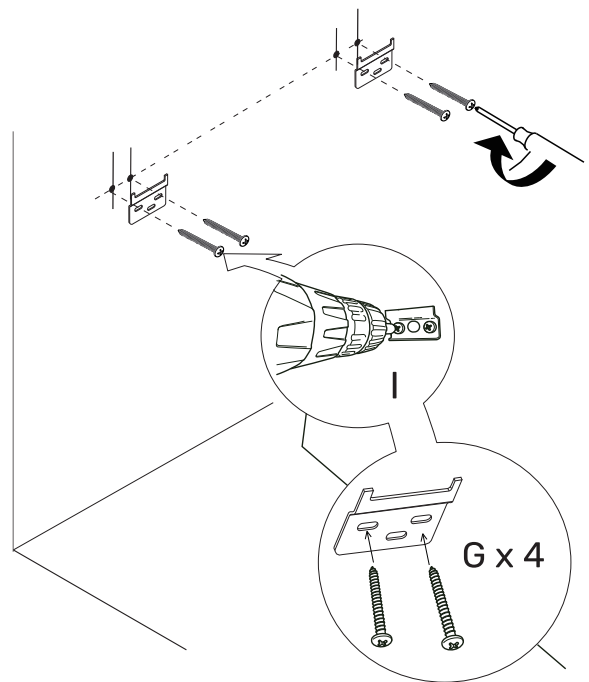
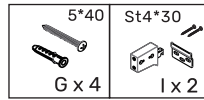

Fix the bracket on the wall using G.

Step 3

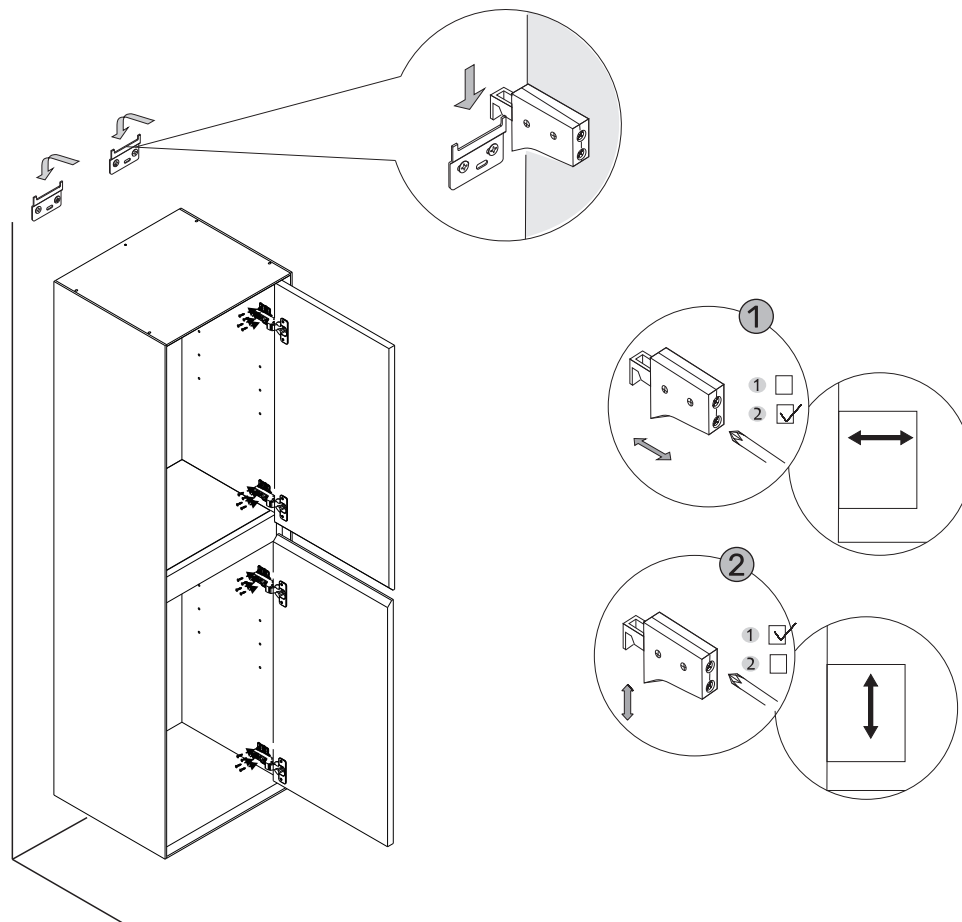

Put the unit on the wall and adjust the lifting code as shown.

Step 4

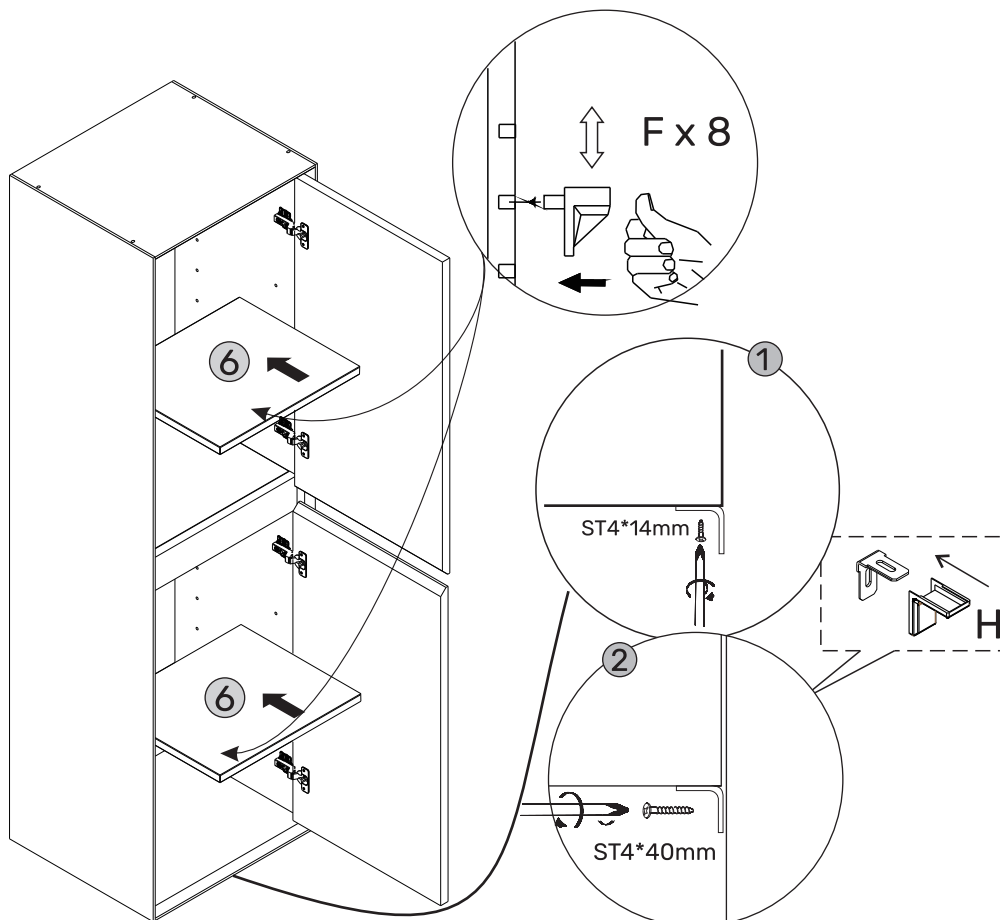
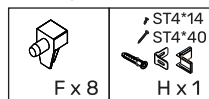

Place panels 6 in the unit and secure using bracket F. Fix the bottom panel onto the wall with the bracket, using ST4*14 and ST4*40 screws.