

WORX®

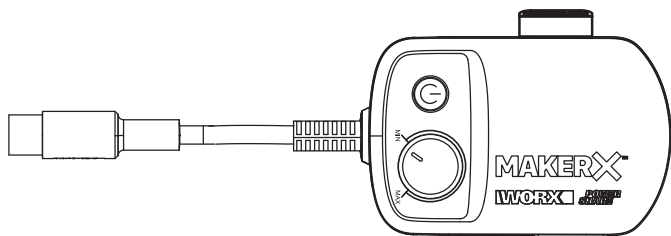

MAKERX™

WA7160 WA7161

EN	Original instructions
D	Originalbetriebsanleitung
F	Notice originale
I	Istruzioni originali
ES	Manual original
PT	Manual original
NL	Oorspronkelijke gebruiksaanwijzing
DK	Original brugsanvisning
NOR	Opprinnelige Instruksjonene
SV	Bruksanvisning i original
PL	Instrukcja oryginalna
GR	ΠΡΩΤΟΤΥΠΟ ΟΔΗΓΙΩΝ ΧΡΗΣΗΣ
HU	Eredeti használati utasítás
RO	Instrucțiuni originale
CZ	Původní návod k používání
SK	Pôvodný návod na použitie
SL	Izvirna navodila

EN	P05
D	P11
F	P17
I	P23
ES	P29
PT	P35
NL	P41
DK	P47
NOR	P53
SV	P59
PL	P65
GR	P71
HU	P77
RO	P83
CZ	P89
SK	P95
SL	P101

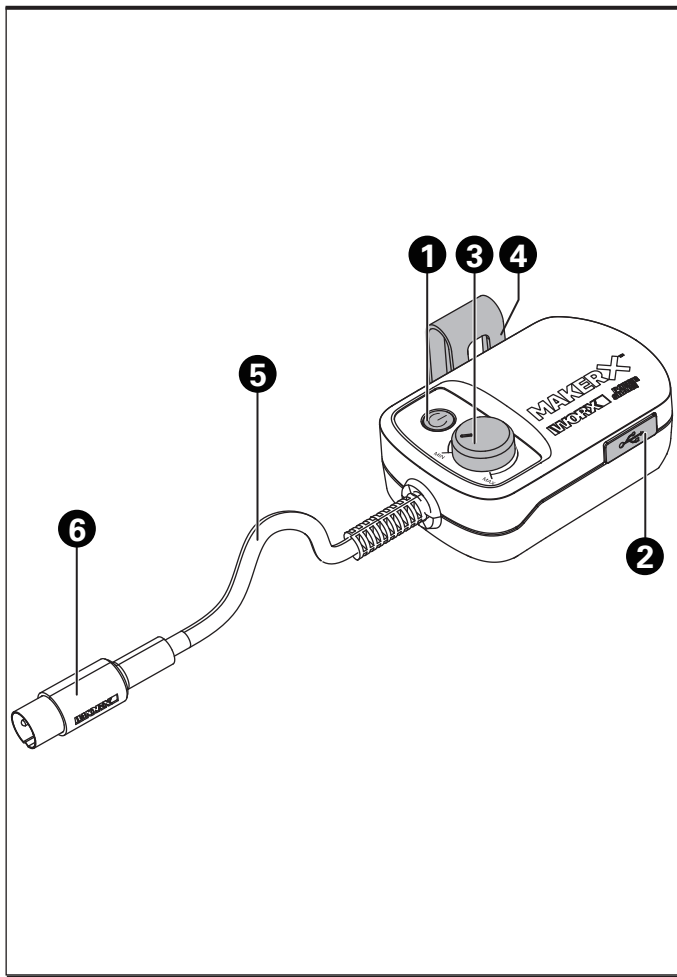

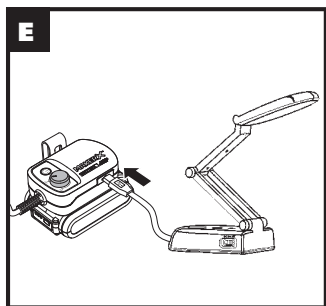
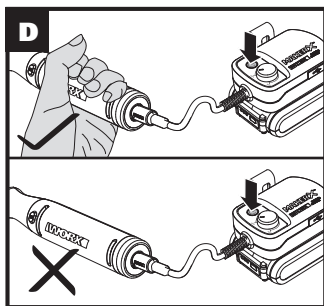
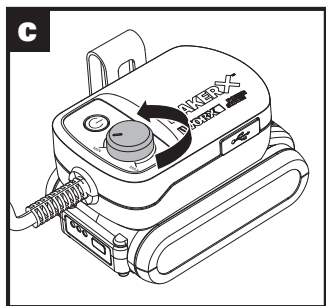
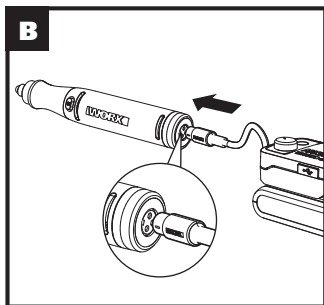
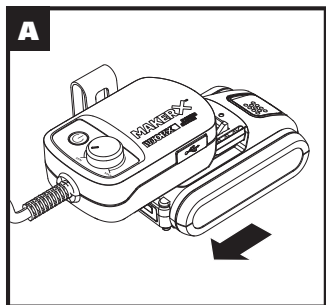

GENERAL POWER TOOL SAFETY WARNINGS



WARNING Read all safety warnings and instructions. Failure to follow the warnings and instructions may result in electric shock, fire and/or serious injury.

Save all warnings and instructions for future reference.

This appliance can be used by children aged from 8 years and above and persons with reduced physical, sensory or mental capabilities or lack of experience and knowledge if they have been given supervision or instruction concerning use of the appliance in a safe way and understand the hazards involved. Children shall not play with the appliance. Cleaning and user maintenance shall not be made by children without supervision.

ADDITIONAL SAFETY INSTRUCTIONS FOR YOUR HUB

1. Before charging, read the instructions.
2. Do not use hub for works other than those for which they are designed.
3. The charging device must be protected from moisture.
4. Do not use the charging device outdoors.
5. Do not open the unit and keep it out of the reach of children.
6. Ensure that the connection between the hub and your equipment is correctly positioned.
7. Keep hub's slots free of foreign objects and protect against dirt and humidity. Store in a dry and frost-free place.
8. When charging your equipment, ensure that the hub is in a well-ventilated area and away from inflammable materials. Ensure that your equipment and hub are not left unsupervised during charging.
9. Longer life and better performance can be obtained if your equipment is charged when the air temperature is between 15°C and 25°C. Do not charge your equipment in air temperatures below 0°C, or above 45°C.
10. Disconnect from your equipment when not charging or the charging is over.









20V Hub/HubX is specially designed to work with 20V MakerX series tools BELOW, so do not attempt to use any other devices.

Category	Model
20V Cordless Rotary Tool	WX739 WX739.X
20V Cordless Angle Grinder	WX741 WX741.X
20V Cordless Air Brush	WX742 WX742.X
20V Cordless Mini Heat Gun	WX743 WX743.X
20V Cordless Wood & Metal Crafter	WX744 WX744.X

SAFETY WARNINGS FOR BATTERY PACK

- a) **Do not dismantle, open or shred cells or battery pack.**
- b) **Do not short-circuit a battery pack. Do not store battery packs haphazardly in a box or drawer where they may short-circuit each other or be short-circuited by conductive materials.** When battery pack is not in use, keep it away from other metal objects, like paper clips, coins, keys, nails, screws or other small metal objects, that can make a connection from one terminal to another. Shorting the battery terminals together may cause burns or a fire.
- c) **Do not expose battery pack to heat or fire. Avoid storage in direct sunlight.**
- d) **Do not subject battery pack to mechanical shock.**
- e) **In the event of battery leaking, do not allow the liquid to come into contact with the skin or eyes. If contact has been made, wash the affected area with copious amounts of water and seek medical advice.**
- f) **Seek medical advice immediately if a cell or battery pack has been swallowed.**
- g) **Keep battery pack clean and dry.**
- h) **Wipe the battery pack terminals with a clean dry cloth if they become dirty.**
- i) **Battery pack needs to be charged before use. Always refer to this instruction and use the correct charging procedure.**
- j) **Do not maintain battery pack on charge when not in use.**
- k) **After extended periods of storage, it may be necessary to charge and discharge the battery pack several times to obtain maximum performance.**
- l) **Battery pack gives its best performance when it is operated at normal room temperature ($20^{\circ}\text{C} \pm 5^{\circ}\text{C}$).**
- m) **When disposing of battery packs, keep battery packs of different electrochemical systems separate from each other.**
- n) **Recharge only with the charger specified by Worx. Do not use any charger other than that specifically provided for use with the equipment.** A charger that is suitable for one type of battery pack may create a risk of fire when used with another battery pack.
- o) **Do not use any battery pack which is not designed for use with the equipment.**
- p) **Keep battery pack out of the reach of children.**
- q) **Retain the original product literature for future reference.**
- r) **Remove the battery from the equipment when not in use.**
- s) **Dispose of properly.**
- t) **Do not mix cells of different manufacture, capacity, size or type within a device.**
- u) **Do not remove battery pack from its original packaging until required for use.**
- v) **Observe the plus (+) and minus (-) marks on the battery and ensure correct use.**

SYMBOLS





	Read the operator's manual.
	Caution
	For indoor use only
	Do not burn
	Batteries may enter water cycle if disposed improperly, which can be hazardous for ecosystem. Do not dispose of waste batteries as unsorted municipal waste.
 Li-Ion	Li-Ion battery. This product has been marked with a symbol relating to 'separate collection' for all battery packs and battery pack. It will then be recycled or dismantled in order to reduce the impact on the environment. Battery packs can be hazardous for the environment and for human health since they contain hazardous substances.
	
 	Waste electrical products must not be disposed of with household waste. Please recycle where facilities exist. Check with your local authorities or retailer for recycling advice

COMPONENT LIST

- 1. ON/OFF SWITCH**
- 2. USB PORT ***
- 3. SPEED CONTROL BUTTON**
- 4. BELT CLIP ***
- 5. FLEXIBLE POWER CORD**
- 6. POWER CONNECTOR**

*** Not all the accessories illustrated or described are included in standard delivery.**

TECHNICAL DATA

	WA7160	WA7161
EN Output	20 V  10 A, Max.	Output : 20 V  10 A, Max. or Output : 5 V  2 A (USB port)
8 Input	20 V  10 A, Max.	
Battery type	Lithium battery	
Battery pack voltage	20 V	
Weight	80 g	

Category	Model	Capacity
20V Battery	WA3551	2.0Ah
	WA3551.1	2.0Ah
	WA3014	4.0Ah
	WA3556	5.0Ah

We recommend that you purchase your accessories listed in the above list from the same store that sold you the tool. Refer to the accessory packaging for further details. Store personnel can assist you and offer advice.

OPERATING INSTRUCTIONS



NOTE: Before using the tool, read the instruction book carefully.

ASSEMBLY

1. Insert battery pack into the hub. (See Fig. A)
2. Connect the hub and MakerX series tools. (See Fig. B)



WARNING: Before operation, make sure the speed control button on the hub is at the "Min" position. (See Fig. C)

OPERATION

1. Confirm the speed control button is set to "Min". Grasp the tool by the grip. Press the on/off switch to start. (See Fig. D)
2. Adjust the variable speed as needed for the tool and application.
3. Press the on/off switch on the hub to turn off after use.

NOTE: For sake of safety, disconnect from the hub and adjust the speed control to "Min" position once completing the operation.

4. With a USB port (output: 5 V, 2 A) (only for specific models), your hub can be connected to a LED light, or used to charge small electronics or tools such as cell phones, cordless screwdrivers, tablets, etc.. (See Fig. E)

MAINTENANCE

There are no repairable parts in your hub.

For adjustment, repair or maintenance, please leave it to the professional. Do not try to repair the hub yourself.

Your hub does not need to be lubricated or otherwise maintained. Don't clean the hub with water or chemical cleaning agent, just wipe it with a dry cloth. Store in a dry environment.

ENVIRONMENTAL PROTECTION



Waste electrical products must not be disposed of with household waste. Please recycle where facilities exist. Check with your local authorities or retailer for recycling advice.

DECLARATION OF CONFORMITY

We,
Positec Germany GmbH
Grüner Weg 10, 50825 Cologne, Germany

Declare that the product
Description **20V Hub/HubX**
Type **WA7160 WA7161**

Complies with the following Directives:
2011/65/EU&(EU)2015/863
2014/30/EU

Standards conform to
EN 55014-1
EN 55014-2
EN 62368-1 (Only for WA7161)

EN

10



2020/07/22
Allen Ding
Deputy Chief Engineer, Testing & Certification
Positec Technology (China) Co., Ltd
18, Dongwang Road, Suzhou Industrial
Park, Jiangsu 215123, P. R. China

WORX®



MAKERX™

WX739 WX739.X

EN	Original instructions
D	Originalbetriebsanleitung
F	Notice originale
I	Istruzioni originali
ES	Manual original
PT	Manual original
NL	Oorspronkelijke gebruiksaanwijzing
DK	Original brugsanvisning
NOR	Opprinnelige Instruksjonene
SV	Bruksanvisning i original
PL	Instrukcja oryginalna
GR	ΠΡΩΤΟΤΥΠΟ ΟΔΗΓΙΩΝ ΧΡΗΣΗΣ
HU	Eredeti használati utasítás
RO	Instrucțiuni originale
CZ	Původní návod k používání
SK	Pôvodný návod na použitie
SL	Izvirna navodila

EN	P06
D	P22
F	P40
I	P57
ES	P74
PT	P90
NL	P107
DK	P124
NOR	P140
SV	P156
PL	P172
GR	P189
HU	P207
RO	P224
CZ	P240
SK	P256
SL	P272

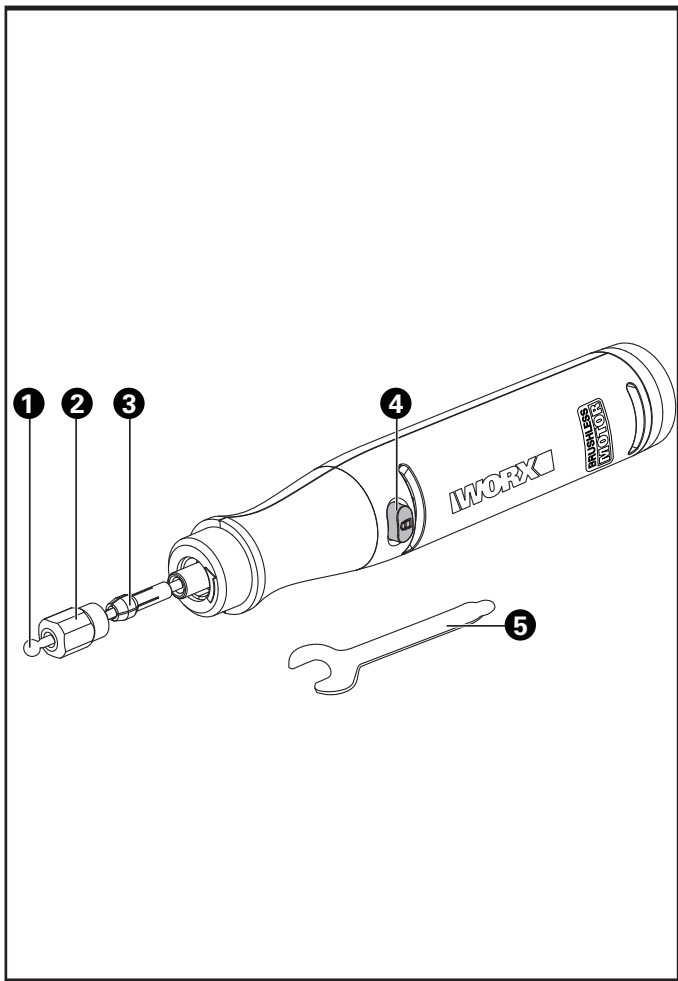

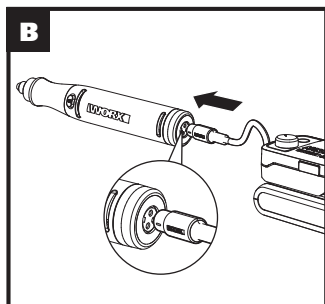
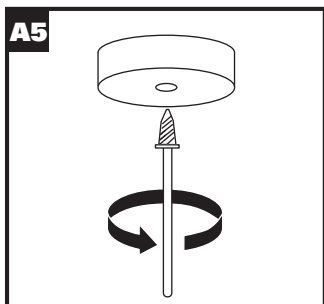
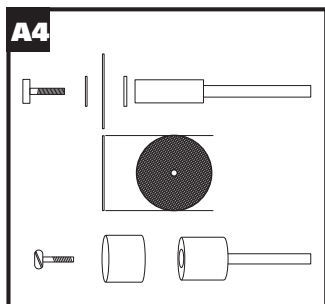
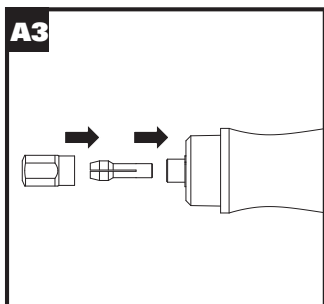
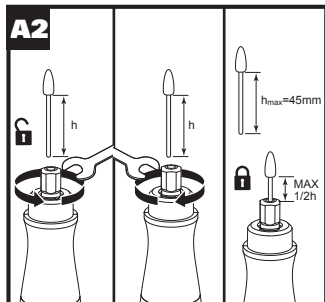
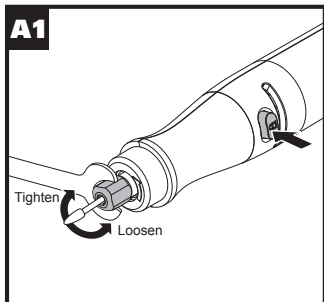

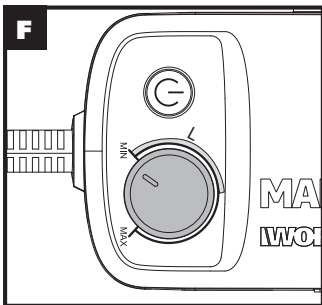
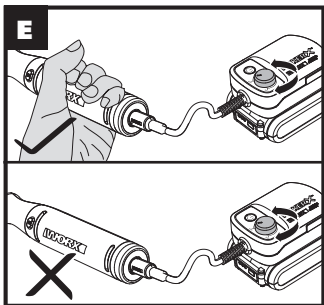
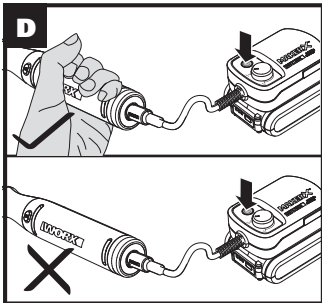
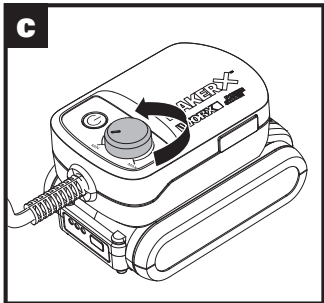

PRODUCT SAFETY

GENERAL POWER TOOL SAFETY WARNINGS



WARNING Read all safety warnings and instructions. Failure to follow the warnings and instructions may result in electric shock, fire and/or serious injury.

Save all warnings and instructions for future reference.

The term "power tool" in the warnings refers to your mains-operated (corded) power tool or battery-operated (cordless) power tool.

1) Work area safety

- a) **Keep work area clean and well lit.** Cluttered or dark areas invite accidents.
- b) **Do not operate power tools in explosive atmospheres, such as in the presence of flammable liquids, gases or dust.** Power tools create sparks which may ignite the dust or fumes.
- c) **Keep children and bystanders away while operating a power tool.** Distractions can cause you to lose control.

2) Electrical safety

- a) **Power tool plugs must match the outlet. Never modify the plug in any way. Do not use any adapter plugs with earthed (grounded) power tools.** Unmodified plugs and matching outlets will reduce risk of electric shock.
- b) **Avoid body contact with earthed or grounded surfaces such as pipes, radiators, ranges and refrigerators.** There is an increased risk of electric shock if your body is earthed or grounded.
- c) **Do not expose power tools to rain or wet conditions.** Water entering a power tool will increase the risk of electric shock.
- d) **Do not abuse the cord. Never use the cord for carrying, pulling or unplugging the power tool. Keep cord away from heat, oil, sharp edges or moving parts.** Damaged or entangled cords increase the risk of electric shock.
- e) **When operating a power tool outdoors, use an extension cord suitable for outdoor use.** Use of a cord suitable for outdoor use reduces the risk of electric shock.
- f) **If operating a power tool in a damp location is unavoidable, use a residual current device (RCD) protected supply.** Use of an RCD reduces the risk of electric shock.

3) Personal safety

- a) **Stay alert, watch what you are doing and use common sense when operating a power tool. Do not use a power tool while you are tired or under the influence of drugs, alcohol or medication.** A moment of inattention while operating power tools may result in serious personal injury.
- b) **Use personal protective equipment. Always wear eye protection.** Protective equipment such as dust mask, non-skid safety shoes, hard hat, or hearing protection used for appropriate conditions will reduce personal injuries.
- c) **Prevent unintentional starting. Ensure the switch is in the off-position before connecting to power source and/or battery pack, picking up or carrying the**

tool. Carrying power tools with your finger on the switch or energising power tools that have the switch on invites accidents.

- d) Remove any adjusting key or wrench before turning the power tool on. A wrench or a key left attached to a rotating part of the power tool may result in personal injury.**
 - e) Do not overreach. Keep proper footing and balance at all times.** *This enables better control of the power tool in unexpected situations.*
 - f) Dress properly. Do not wear loose clothing or jewelry. Keep your hair, clothing and gloves away from moving parts.** *Loose clothes, jewelry or long hair can be caught in moving parts.*
 - g) If devices are provided for the connection of dust extraction and collection facilities, ensure these are connected and properly used.** *Use of dust collection can reduce dust-related hazards.*
- 4) Power tool use and care**
- a) Do not force the power tool. Use the correct power tool for your application.** *The correct power tool will do the job better and safer at the rate for which it was designed.*
 - b) Do not use the power tool if the switch does not turn it on and off.** *Any power tool that cannot be controlled with the switch is dangerous and must be repaired.*
 - c) Disconnect the plug from the power source and/or the battery pack from the power tool before making any adjustments, changing accessories, or storing power tools.** *Such preventive safety measures reduce the risk of starting the power tool accidentally.*
 - d) Store idle power tools out of the reach of children and do not allow persons unfamiliar with the power tool or these instructions to operate the power tool.** *Power tools are dangerous in the hands of untrained users.*
 - e) Maintain power tools. Check for misalignment or binding of moving parts, breakage of parts and any other condition that may affect the power tools operation. If damaged, have the power tool repaired before use.** *Many accidents are caused by poorly maintained power tools.*
 - f) Keep cutting tools sharp and clean.** *Properly maintained cutting tools with sharp cutting edges are less likely to bind and are easier to control.*
 - g) Use the power tool, accessories and tool bits etc., in accordance with these instructions and in the manner intended for the particular type of power tool, taking into account the working conditions and the work to be performed.** *Use of the power tool for operations different from those intended could result in a hazardous situation.*
- 5) Battery tool use and care**
- a) Recharge only with the charger specified by the manufacturer.** *A charger that is suitable for one type of battery pack may create a risk of fire when used with another battery pack.*
 - b) Use power tools only with specifically designated battery packs.** *Use of any other battery packs may create a risk of injury and fire.*
 - c) When battery pack is not in use, keep it away from other metal objects, like**

paper clips, coins, keys, nails, screws or other small metal objects, that can make a connection from one terminal to another. *Shorting the battery terminals together may cause burns or a fire.*

- d) Under abusive conditions, liquid may be ejected from the battery; avoid contact. If contact accidentally occurs, flush with water. If liquid contacts eyes, additionally seek medical help.** *Liquid ejected from the battery may cause irritation or burns.*
- 6) Service**
- a) Have your power tool serviced by a qualified repair person using only identical replacement parts.** *This will ensure that the safety of the power tool is maintained.*

SAFETY INSTRUCTIONS FOR ALL OPERATIONS :

Safety warnings common for grinding, sanding, wire brushing, polishing, carving or abrasive cutting-off operations:

- a) This power tool is intended to function as a grinder, sander, wire brush, polisher, carving or cut-off tool. Read all safety warnings, instructions, illustrations and specifications provided with this power tool.** *Failure to follow all instructions listed below may result in electric shock, fire and/or serious injury.*
- b) Do not use accessories which are not specifically designed and recommended by the tool manufacturer.** *Just because the accessory can be attached to your power tool, it does not assure safe operation.*
- c) The rated speed of the accessories must be at least equal to the maximum speed setting marked on the power tool.** *Grinding accessories running faster than their rated speed can break and fly apart.*
- d) The outside diameter and the thickness of your accessory must be within the capacity rating of your power tool.** *Incorrectly sized accessories cannot be adequately controlled.*
- e) The arbour size of wheels, sanding drums or any other accessory must properly fit the spindle or collet of the power tool.** *Accessories that do not match the mounting hardware of the power tool will run out of balance, vibrate excessively and may cause loss of control.*
- f) Mandrel mounted wheels, sanding drums, cutters or other accessories must be fully inserted into the collet or chuck.** *If the mandrel is insufficiently held and/ or the overhang of the wheel is too long, the mounted wheel may become loose and be ejected at high velocity.*
- g) Do not use a damaged accessory. Before each use inspect the accessory such as abrasive wheels for chips and cracks, sanding drum for cracks, tear or excess wear, wire brush for loose or cracked wires. If power tool or accessory is dropped, inspect for damage or install an undamaged accessory. After inspecting and installing an accessory, position yourself and bystanders away from the plane of the rotating accessory and run the power tool at maximum no-load speed for one minute.** *Damaged accessories will normally break apart during this test time.*

- h) Wear personal protective equipment. Depending on application, use face shield, safety goggles or safety glasses. As appropriate, wear dust mask, hearing protectors, gloves and workshop apron capable of stopping small abrasive or workpiece fragments.** *The eye protection must be capable of stopping flying debris generated by various operations. The dust mask or respirator must be capable of filtering particles generated by your operation. Prolonged exposure to high intensity noise may cause hearing loss.*
- i) Keep bystanders a safe distance away from work area. Anyone entering the work area must wear personal protective equipment.** *Fragments of workpiece or of a broken accessory may fly away and cause injury beyond immediate area of operation.*
- j) Hold power tool by insulated gripping surfaces only, when performing an operation where the cutting accessory may contact hidden wiring.** *Cutting accessory contacting a "live" wire may make exposed metal parts of the power tool "live" and could give the operator an electric shock.*
- k) Always hold the tool firmly in your hand(s) during the start-up.** *The reaction torque of the motor, as it accelerates to full speed, can cause the tool to twist.*
- l) Use clamps to support workpiece whenever practical. Never hold a small workpiece in one hand and the tool in the other hand while in use.** *Clamping a small workpiece allows you to use your hand(s) to control the tool. Round material such as dowel rods, pipes or tubing have a tendency to roll while being cut, and may cause the bit to bind or jump toward you.*
- m) Position the cord clear of the spinning accessory.** *If you lose control, the cord may be cut or snagged and your hand or arm may be pulled into the spinning accessory.*
- n) Never lay the power tool down until the accessory has come to a complete stop.** *The spinning accessory may grab the surface and pull the power tool out of your control.*
- o) After changing the bits or making any adjustments, make sure the collet nut, chuck or any other adjustment devices are securely tightened.** *Loose adjustment devices can unexpectedly shift, causing loss of control, loose rotating components will be violently thrown.*
- p) Do not run the power tool while carrying it at your side.** *Accidental contact with the spinning accessory could snag your clothing, pulling the accessory into your body.*
- q) Regularly clean the power tool's air vents.** *The motor's fan will draw the dust inside the housing and excessive accumulation of powdered metal may cause electrical hazards.*
- r) Do not operate the power tool near flammable materials.** *Sparks could ignite these materials.*
- s) Do not use accessories that require liquid coolants.** *Using water or other liquid coolants may result in electrocution or shock.*

FURTHER SAFETY INSTRUCTIONS FOR ALL OPERATIONS

Kickback and related warnings

Kickback is a sudden reaction to a pinched or snagged rotating wheel, sanding band, brush or any other accessory. Pinching or snagging causes rapid stalling of the rotating accessory

which in turn causes the uncontrolled power tool to be forced in the direction opposite of the accessory's rotation.

For example, if an abrasive wheel is snagged or pinched by the workpiece, the edge of the wheel that is entering into the pinch point can dig into the surface of the material causing the wheel to climb out or kick out. The wheel may either jump toward or away from the operator, depending on direction of the wheel's movement at the point of pinching. Abrasive wheels may also break under these conditions.

Kickback is the result of power tool misuse and/or incorrect operating procedures or conditions and can be avoided by taking proper precautions as given below.

- a) **Maintain a firm grip on the power tool and position your body and arm to allow you to resist kickback forces.** *The operator can control kickback forces, if proper precautions are taken.*
- b) **Use special care when working corners, sharp edges etc. Avoid bouncing and snagging the accessory.** *Corners, sharp edges or bouncing have a tendency to snag the rotating accessory and cause loss of control or kickback.*
- c) **Do not attach a toothed saw blade.** *Such blades create frequent kickback and loss of control.*
- d) **Always feed the bit into the material in the same direction as the cutting edge is exiting from the material (which is the same direction as the chips are thrown).** *Feeding the tool in the wrong direction causes the cutting edge of the bit to climb out of the work and pull the tool in the direction of this feed.*
- e) **When using rotary files, cut-off wheels, high-speed cutters or tungsten carbide cutters, always have the work securely clamped.** *These wheels will grab if they become slightly canted in the groove, and can kickback. When a cut-off wheel grabs, the wheel itself usually breaks. When a rotary file, high-speed cutter or tungsten carbide cutter grabs, it may jump from the groove and you could lose control of the tool.*

SAFETYWARNINGSSPECIFICFORGRINDINGANDABRASIVECUTTING-OFFOPERATIONS:

- a) **Use only wheel types that are recommended for your power tool and only for recommended applications. For example: do not grind with the side of a cut-off wheel.** *Abrasive cut-off wheels are intended for peripheral grinding, side forces applied to these wheels may cause them to shatter.*
- b) **For threaded abrasive cones and plugs use only undamaged wheel mandrels with an unrelieved shoulder flange that are of correct size and length.** *Proper mandrels will reduce the possibility of breakage.*
- c) **Do not "jam" a cut-off wheel or apply excessive pressure. Do not attempt to make an excessive depth of cut.** *Overstressing the wheel increases the loading and susceptibility to twisting or snagging of the wheel in the cut and the possibility of kickback or wheel breakage.*
- d) **Do not position your hand in line with and behind the rotating wheel.** *When the wheel, at the point of operation, is moving away from your hand, the possible kickback may propel the spinning wheel and the power tool directly at you.*
- e) **When wheel is pinched, snagged or when interrupting a cut for any reason, switch off the power tool and hold the power tool motionless until the wheel**

comes to a complete stop. Never attempt to remove the cut-off wheel from the cut while the wheel is in motion otherwise kickback may occur. Investigate and take corrective action to eliminate the cause of wheel pinching or snagging.

- f) **Do not restart the cutting operation in the workpiece. Let the wheel reach full speed and carefully re-enter the cut.** The wheel may bind, walk up or kickback if the power tool is restarted in the workpiece.
- g) **Support panels or any oversized workpiece to minimize the risk of wheel pinching and kickback.** Large workpieces tend to sag under their own weight. Supports must be placed under the workpiece near the line of cut and near the edge of the workpiece on both sides of the wheel.
- h) **Use extra caution when making a "pocket cut" into existing walls or other blind areas.** The protruding wheel may cut gas or water pipes, electrical wiring or objects that can cause kickback.

SAFETY WARNINGS SPECIFIC FOR WIRE BRUSHING OPERATIONS:

- a) **Be aware that wire bristles are thrown by the brush even during ordinary operation. Do not overstress the wires by applying excessive load to the brush.** The wire bristles can easily penetrate light clothing and/or skin.
- b) **Allow brushes to run at operating speed for at least one minute before using them. During this time no one is to stand in front or in line with the brush.** Loose bristles or wires will be discharged during the run-in time.
- c) **Direct the discharge of the spinning wire brush away from you.** Small particles and tiny wire fragments may be discharged at high velocity during the use of these brushes and may become imbedded in your skin.

EN





11

SAFETY WARNINGS FOR BATTERY PACK

- a) **Do not dismantle, open or shred cells or battery pack.**
- b) **Do not short-circuit a battery pack. Do not store battery packs haphazardly in a box or drawer where they may short-circuit each other or be short-circuited by conductive materials.** When battery pack is not in use, keep it away from other metal objects, like paper clips, coins, keys, nails, screws or other small metal objects, that can make a connection from one terminal to another. Shorting the battery terminals together may cause burns or a fire.
- c) **Do not expose battery pack to heat or fire. Avoid storage in direct sunlight.**
- d) **Do not subject battery pack to mechanical shock.**
- e) **In the event of battery leaking, do not allow the liquid to come into contact with the skin or eyes. If contact has been made, wash the affected area with copious amounts of water and seek medical advice.**
- f) **Seek medical advice immediately if a cell or battery pack has been swallowed.**
- g) **Keep battery pack clean and dry.**

- h) **Wipe the battery pack terminals with a clean dry cloth if they become dirty.**
- i) **Battery pack needs to be charged before use. Always refer to this instruction and use the correct charging procedure.**
- j) **Do not maintain battery pack on charge when not in use.**
- k) **After extended periods of storage, it may be necessary to charge and discharge the battery pack several times to obtain maximum performance.**
- l) **Battery pack gives its best performance when it is operated at normal room temperature ($20^{\circ}\text{C} \pm 5^{\circ}\text{C}$).**
- m) **When disposing of battery packs, keep battery packs of different electrochemical systems separate from each other.**
- n) **Recharge only with the charger specified by Worx. Do not use any charger other than that specifically provided for use with the equipment.** *A charger that is suitable for one type of battery pack may create a risk of fire when used with another battery pack.*
- o) **Do not use any battery pack which is not designed for use with the equipment.**
- p) **Keep battery pack out of the reach of children.**
- q) **Retain the original product literature for future reference.**
- r) **Remove the battery from the equipment when not in use.**
- s) **Dispose of properly.**
- t) **Do not mix cells of different manufacture, capacity, size or type within a device.**
- u) **Do not remove battery pack from its original packaging until required for use.**
- v) **Observe the plus (+) and minus (-) marks on the battery and ensure correct use.**

SYMBOLS

	To reduce the risk of injury, user must read instruction manual
	Warning
	Wear eye protection
	Wear ear protection



Wear dust mask



Do not burn



Batteries may enter water cycle if disposed improperly, which can be hazardous for ecosystem. Do not dispose of waste batteries as unsorted municipal waste.



Li-Ion battery. This product has been marked with a symbol relating to 'separate collection' for all battery packs and battery pack. It will then be recycled or dismantled in order to reduce the impact on the environment. Battery packs can be hazardous for the environment and for human health since they contain hazardous substances.



Waste electrical products must not be disposed of with household waste. Please recycle where facilities exist. Check with your local authorities or retailer for recycling advice

COMPONENT LISTS

1. CARVING BIT
2. CHUCK
3. COLLET
4. SPINDLE LOCK BUTTON
5. SPANNER

Not all the accessories illustrated or described are included in standard delivery.

TECHNICAL DATA

Type Designation **WX739 WX739.X (739-designation of machinery, representative of rotary tool)**

	WX739 WX739.X**
Voltage	20 V  Max***
Motor type	Brushless
Collet size	3.2 mm
Rated capacity	38 mm
Spindle thread	M7
Rated speed	5000-35000 rpm
Machine weight (bare tool)	130 g

** X=1-99, A-Z, M1-M9 there are only used for different customers, there are no safe relevant changes between these models.

*** Voltage measured without workload. Initial battery voltage reaches maximum of 20 volts. Nominal voltage is 18 volts.

NOISE INFORMATION

A weighted sound pressure	L_{DA} : 70.3 dB(A)
A weighted sound power	L_{WA} : 81.3 dB(A)
K_{DA} & K_{WA}	3 dB(A)
Wear ear protection.	

VIBRATION INFORMATION

Vibration total values (triax vector sum) determined according to EN 60745:

Vibration emission value $a_h = 2.162 \text{ m/s}^2$

Uncertainty $K = 1.5 \text{ m/s}^2$

The declared vibration total value may be used for comparing one tool with another, and may also be used in a preliminary assessment of exposure.



WARNING: The vibration emission value during actual use of the power tool can differ from the declared value depending on the ways in which the tool is used dependant on the following examples and other variations on how the tool is used:

How the tool is used and the materials being cut or drilled.

The tool being in good condition and well maintained

The use the correct accessory for the tool and ensuring it is sharp and in good condition.

The tightness of the grip on the handles and if any anti vibration accessories are used.

And the tool is being used as intended by its design and these instructions.

This tool may cause hand-arm vibration syndrome if its use is not adequately managed.



WARNING! To be accurate, an estimation of exposure level in the actual conditions of use should also take account of all parts of the operating cycle such as the times when the tool is switched off and when it is running idle but not actually doing the job. This may significantly reduce the exposure level over the total working period.

Helping to minimise your vibration exposure risk.

ALWAYS use sharp chisels, drills and blades





Maintain this tool in accordance with these instructions and keep well lubricated (where appropriate)

If the tool is to be used regularly then invest in anti vibration accessories.

Plan your work schedule to spread any high vibration tool use across a number of days.

EN

15

Category	Model	Capacity
20V Hub/HubX	WA7160	Input: 20 V  10 A Max. Output: 20 V  10 A Max.
	WA7161	Input: 20 V  10 A Max. Output 1: 20 V  10 A Max. Output 2: 5 V  2 A (USB port)

Only use the appropriate accessories intended for this tool. Accessory information can be found on the product packaging, at a Worx dealer or on our website at www.worx.com. MakerX series tools and 20V Hub/HubX are specially designed to work together, so do not attempt to use any other devices.

OPERATING INSTRUCTIONS



NOTE: Before using the tool, read the instruction book carefully.

Intended use

This tool is intended for drilling, cutting, sanding, carving, polishing and grinding.

ASSEMBLY

1. Press and hold the spindle lock button. Loosen the chuck first to insert the accessory into the collet. Then use the spanner to tighten. (See Fig. A1, A2, A3, A4, A5)

More information about accessories, please check the table below.

NOTE: Before changing the accessories, make sure your machine is turned off and disconnected from the hub.



WARNING: To reduce the risk of injury, use only accessories rated for the operating speed setting of the tool.

2. Connect the rotary tool to the hub. (See Fig. B)



WARNING: Before operation, make sure the speed control button on the hub is at the "Min" position. (See Fig. C)

OPERATION

1. Confirm the speed control button is set to "Min". Grasp the tool by the grip. Press the on/off switch on the hub to start the machine. (See Fig. D)

NOTE: Always start at no load to achieve maximum speed then start working. Do not use excessive contact pressure! A correct and uniform speed enables better performance.

2. Adjust speed as needed. (See Fig. E)

3. Press the on/off switch on the hub to turn off after use.

NOTE: For sake of safety, disconnect from the hub and adjust the speed control button to "Min" position once completing the operation.

MAINTENANCE

Remove the battery pack from the machine before carrying out any adjustment, servicing or maintenance.

Please do not disassemble the machine by yourself, contact service agent for maintenance.

Your power tool requires no additional lubrication or maintenance.

There are no user serviceable parts in your power tool. Never use water or chemical cleaners to clean your power tool. Wipe clean with a dry cloth. Always store your power tool in a dry place. Keep the motor ventilation slots clean. Keep all working controls free of dust. Occasionally you may see sparks through the ventilation slots. This is normal and will not damage your power tool.

ENVIRONMENTAL PROTECTION



Waste electrical products must not be disposed of with household waste. Please recycle where facilities exist. Check with your local authorities or retailer for recycling advice.

DECLARATION OF CONFORMITY

We,
Positec Germany GmbH
Grüner Weg 10, 50825 Cologne, Germany

Declare that the product

Description **Battery operated die grinder**

Type **WX739 WX739.X (739-designation of machinery, representative of grinder, polisher and sander)**

Function **Grinding, drilling, sanding, polishing, cutting**

Complies with the following Directives:

2006/42/EC

2011/65/EU&(EU)2015/863

2014/30/EU

Standards conform to

EN 55014-1

EN 55014-2

EN 60745-1

EN 60745-2-3

The person authorized to compile the technical file,

Name Marcel Filz

Anschrift Positec Germany GmbH

Grüner Weg 10, 50825 Cologne, Germany



2020/07/22

Allen Ding

Deputy Chief Engineer, Testing & Certification







Positec Technology (China) Co., Ltd









18, Dongwang Road, Suzhou Industrial







Park, Jiangsu 215123, P. R. China





ACCESSORIES

"L" represents low speed, and is recommended to maximize accessory performance and life. (See Fig. F)

	Pic	Description	Cork	Wood	Plastic	Steel	Aluminum, brass, etc.	Shell, stone	Ceramic	Glass
Sanding		Sanding paper	✓	✓	✓	×	✓	×	×	×
		Sanding bands	✓	✓	✓	✓	✓	✓	✓	×
		Flap wheel	✓ (L)	✓ (L)	×	×	×	×	×	×
Cutting		Diamond wheel	×	×	×	×	×	✓	✓	✓
		Cut off wheels fiberglass	×	×	×	✓	✓	×	×	×
		Cut off wheels	×	×	×	✓	✓	×	×	×

	Pic	Description	Cork	Wood	Plastic	Steel	Aluminum, brass, etc.	Shell, stone	Ceramic	Glass
Grinding/ Sharpening		Aluminum oxide Grinding wheels/ silicon carbide Grinding wheels	×	×	✓	✓	✓	✓	✓	×
		Silicon carbide Grinding wheels with shank	×	×	✓	✓	✓	✓	✓	×
		Aluminum oxide Grinding wheels with shank	×	×	✓	✓	✓	✓	✓	×
		Rubber emery wheel	×	×	×	✓	✓	×	×	✓
		Rubber grinder with shank	×	×	×	✓	✓	×	×	✓
Carving/ Engraving		Diamond grinding needle	✓	✓	✓	✓	✓	✓	✓	✓
		HSS cutter	✓	✓	✓	×	×	×	×	×
Drilling		HSS drill	✓	✓	✓	×	×	×	×	×

	Pic	Description	Cork	Wood	Plastic	Steel	Aluminum, brass, etc.	Shell, stone	Ceramic	Glass
Cleaning/ Polishing		Bristle brushes	✓ (L)	✓ (L)	✓ (L)	✓ (L)	✓ (L)	✓ (L)	✓ (L)	✓ (L)
		Stainless steel brushes	✓ (L)	✓ (L)	✓ (L)	✓ (L)	✓ (L)	✓ (L)	✓ (L)	✓ (L)
		Brass brushes	✓ (L)	✓ (L)	✓ (L)	✓ (L)	✓ (L)	✓ (L)	✓ (L)	✓ (L)
		Felt wheel pointed/ Felt wheels/ Cloth wheel	✓ (L)	✓ (L)	✓ (L)	✓ (L)	✓ (L)	✓ (L)	✓ (L)	✓ (L)
		Wool polishing with shank	✓	✓	✓	✓	✓	✓	✓	✓
		Polishing compound	Use with Felt wheel pointed/Felt wheels/Cloth wheel							

Accessories		Collets	Suitable for size 1/8, 3/32, 1/16 accessories
		Wrench	Fixing the attachments
		Whetstone	Adjust the concentricity of Grinding Wheels to keep them in good condition
		Mandrel for cut off wheel	To link Rubber emery wheel/Sanding paper/Diamond wheel/Cut off wheels/Grinding wheels
		Sanding Drum	Use to mount sanding sleeves

WORX®



MAKER X™

WX744 WX744.X

EN	Original instructions
D	Originalbetriebsanleitung
F	Notice originale
I	Istruzioni originali
ES	Manual original
PT	Manual original
NL	Oorspronkelijke gebruiksaanwijzing
DK	Original brugsanvisning
NOR	Opprinnelige Instruksjonene
SV	Bruksanvisning i original
PL	Instrukcja oryginalna
GR	ΠΡΩΤΟΤΥΠΟ ΟΔΗΓΙΩΝ ΧΡΗΣΗΣ
HU	Eredeti használati utasítás
RO	Instrucțiuni originale
CZ	Původní návod k používání
SK	Pôvodný návod na použitie
SL	Izvirna navodila

EN	P08
D	P15
F	P23
I	P32
ES	P40
PT	P48
NL	P56
DK	P64
NOR	P71
SV	P79
PL	P86
GR	P95
HU	P104
RO	P112
CZ	P120
SK	P128
SL	P136

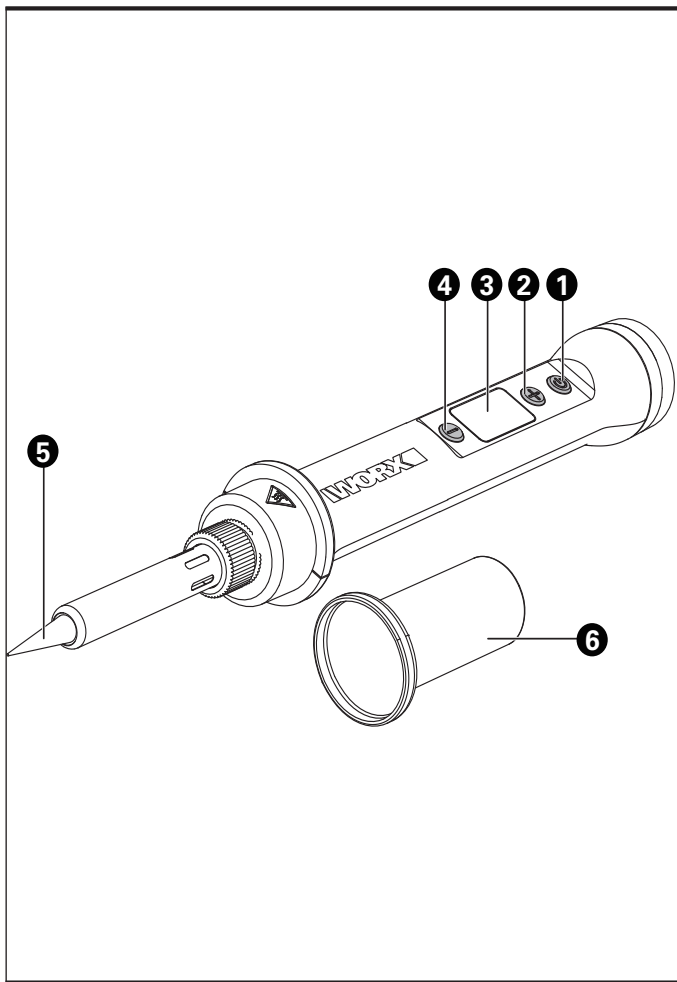

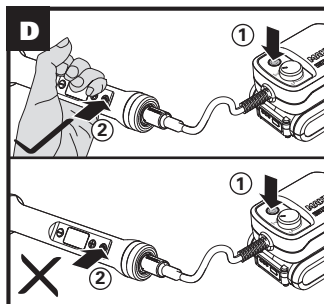
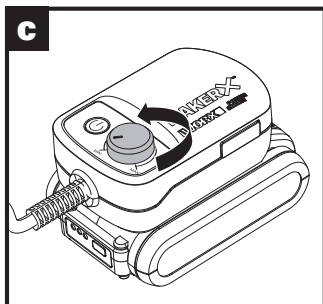
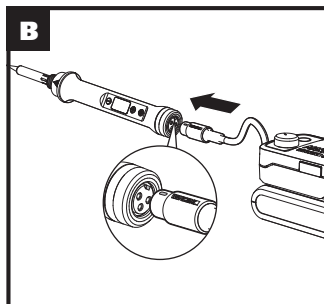
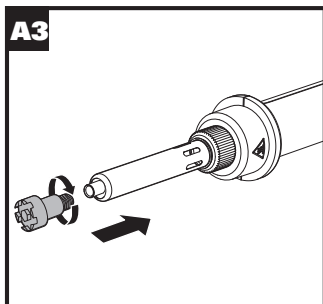
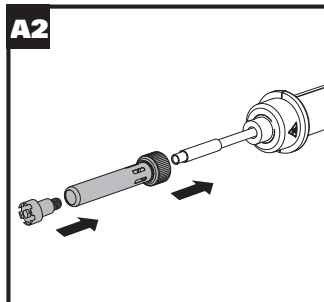
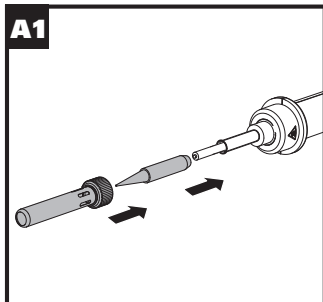

E1

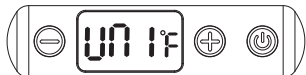

E2

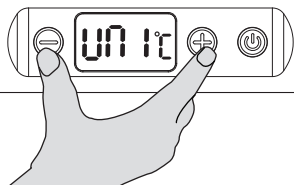

PRODUCT SAFETY

GENERAL SAFETY WARNINGS

 **WARNING: Read all safety warnings and instructions.** *Failure to follow all instructions listed below may result in electric shock, fire and/or serious injury.*

Save all warnings and instructions for future reference.

This appliance can be used by children aged from 8 years and above and persons with reduced physical, sensory or mental capabilities or lack of experience and knowledge if they have been given supervision or instruction concerning use of the appliance in a safe way and understand the hazards involved. Children shall not play with the appliance. Cleaning and user maintenance shall not be made by children without supervision. **WARNING:** For the purposes of recharging the battery, only use the detachable supply unit provided with this appliance.

ADDITIONAL SAFETY RULES FOR CRAFTER

WARNING: This tool must be placed on its stand when not in use.

A fire may result if the appliance is not used with

care, therefore

- be careful when using the appliance in places where there are combustible materials;
- do not apply to the same place for a long time;
- do not use in presence of an explosive atmosphere;
- be aware that heat may be conducted to combustible materials that are out of sight;
- place the appliance on its stand after use and allow it to cool down before storage;
- do not leave the appliance unattended when it is switched on.

SAFETY WARNINGS FOR BATTERY PACK

a) Do not dismantle, open or shred cells or battery pack.

b) Do not short-circuit a battery pack. Do not store battery packs haphazardly in a box or drawer where they may short-circuit each other or be short-circuited by conductive materials. When battery pack is not in use, keep it away from other metal objects, like paper clips, coins, keys, nails, screws or other small metal objects, that can make a connection from one terminal to another. Shorting the battery terminals together may

cause burns or a fire.

c) Do not expose battery pack to heat or fire. Avoid storage in direct sunlight.

d) Do not subject battery pack to mechanical shock.

e) In the event of battery leaking, do not allow the liquid to come into contact with the skin or eyes. If contact has been made, wash the affected area with copious amounts of water and seek medical advice.

f) Seek medical advice immediately if a cell or battery pack has been swallowed.

g) Keep battery pack clean and dry.

h) Wipe the battery pack terminals with a clean dry cloth if they become dirty.

i) Battery pack needs to be charged before use. Always refer to this instruction and use the correct charging procedure.

j) Do not maintain battery pack on charge when not in use.

k) After extended periods of storage, it may be necessary to charge and discharge the battery pack several times to obtain maximum performance.

l) Battery pack gives its best performance when it is operated at normal room temperature ($20^{\circ}\text{C} \pm 5^{\circ}\text{C}$).

m) When disposing of battery packs, keep battery packs of different electrochemical systems separate from each other.

n) Recharge only with the charger specified by Worx. Do not use any charger other than that specifically provided for use with the equipment.

A charger that is suitable for one type of battery pack may create a risk of fire when used with another battery pack.

o) Do not use any battery pack which is not designed for use with the equipment.

p) Keep battery pack out of the reach of children.

q) Retain the original product literature for future reference.

r) Remove the battery from the equipment when not in use.











s) Dispose of properly.

t) Do not mix cells of different manufacture, capacity, size or type within a device.

u) Do not remove battery pack from its original packaging until required for use.

v) Observe the plus (+) and minus (-) marks on the battery and ensure correct use.

SYMBOLS

	Read operator's manual
	Wear eye protection
	Wear protective gloves
	Warning
	Do not burn
	Batteries may enter water cycle if disposed improperly, which can be hazardous for ecosystem. Do not dispose of waste batteries as unsorted municipal waste.
 Li-Ion	Li-Ion battery. This product has been marked with a symbol relating to 'separate collection' for all battery packs and battery pack. It will then be recycled or dismantled in order to reduce the impact on the environment. Battery packs can be hazardous for the environment and for human health since they contain hazardous substances.
	
 	Waste electrical products must not be disposed of with household waste. Please recycle where facilities exist. Check with your local authorities or retailer for recycling advice.

COMPONENT LIST

- 1. POWER BUTTON**
- 2. "+" BUTTON**
- 3. LCD DISPLAY**
- 4. "-" BUTTON**
- 5. CRAFTER TIP**
- 6. COMFORT SLEEVE (OPTIONAL)**

Not all the accessories illustrated or described are included in standard delivery.





TECHNICAL DATA

Type **WX744 WX744.X (744 - designation of machinery, representative of crafter)**

	WX744 WX744.X *
Rated voltage	20 V  Max. **
Power input	45 W
Max temperature	200 °C-480 °C
Battery type	Lithium battery
Machine weight (bare tool)	54 g

* X=1-999, A-Z, M1-M9 there are only used for different customers, there are no safe relevant changes between these models.

** Voltage measured without workload. Initial battery voltage reaches maximum of 20 volts. Nominal voltage is 18 volts.

Category	Model	Capacity
20V Hub/HubX	WA7160	Input: 20 V  10 A Max. Output: 20 V  10 A Max.
	WA7161	Input: 20 V  10 A Max. Output 1: 20 V  10 A Max. Output 2: 5 V  2 A (USB port)

We recommend that you purchase your accessories from the same store that sold you the tool. Refer to the accessory packaging for further details. Store personnel can assist you and offer advice.

MakerX series tools and 20V Hub/HubX are specially designed to work together, so do not attempt to use any other devices.

OPERATING INSTRUCTIONS



NOTE: Before using the tool, read the instruction book carefully.

ASSEMBLY

1. Assemble the crafter tips as shown in Fig. A1-A3.
2. Connect the crafter and the hub. (See Fig. B)



WARNING: Before operation, make sure the speed control button on the hub is at the "Min" position. (See Fig. C)

OPERATION

1. Confirm the speed control button is set to "Min". Grasp the tool by the grip. Press on/off switch on the hub. Then press and hold the power button on the crafter to start working. (See Fig. D)

NOTE: The speed is fixed, and can not be adjusted by the speed control button on the hub.

During operation, the crafter will enter into auto sleep with no movement for approximately 5 minutes or more. The temperature will drop to 200 °C and the crafter automatically turns off 10 minutes later. It will display "OFF".



WARNING: During initial use, the crafter may generate a light smoke due to elements heating, which is normal.

While the crafter is heating, DO NOT touch the metallic parts near the tip and DO NOT remove or replace the tip.

Never operate the crafter while people, especially young children are nearby. Be careful. The crafter remains hot after the work is concluded.

2. Press the on/off switch on the hub to turn off after use.

NOTE: Use the trestle to place the crafter when not in use.

3. Adjust temperature as needed.

Press on/off switch on the hub. Use "+" or "-" button to adjust temperature (the temperature will increase / decrease by 10 °C each time the "+" or "-" button is pressed).

NOTE: The temperature cannot be adjusted during the heating or cooling process.

4. Switch °F and °C as needed. (See Fig. E1, E2)

Press on/off switch on the hub. With the crafter turned off, press both "+" and "-" button and "UNI" will be shown on the LCD display. Then press both "+" and "-" button to switch the temperature mode. After selection, wait for 3 seconds and then it will display "OFF".

5. Your Wood & Metal Crafter comes with an optional silicon Comfort Sleeve. To

enhance the grip, simply slide the sleeve over the nose of the tool.

MAINTENANCE

Remove the battery before carrying out any adjustment, servicing or maintenance.

There are no user serviceable parts in your power tool. Never use water or chemical cleaners to clean your power tool. Wipe clean with a dry cloth. Always store your power tool in a dry place. Keep the motor ventilation slots clean. Keep all working controls free of dust. Occasionally you may see sparks through the ventilation slots. This is normal and will not damage your power tool. Store the accessories in a dry place.

ENVIRONMENTAL PROTECTION



Waste electrical products must not be disposed of with household waste. Please recycle where facilities exist. Check with your local authorities or retailer for recycling advice.

DECLARATION OF CONFORMITY

We,
Positec Germany GmbH
Grüner Weg 10, 50825 Cologne, Germany

Declare that the product

Description **Wood & Metal Crafter**

Type **WX744 WX744.X (744 - designation of machinery, representative of crafter)**

Function **Wire joining, wood burning**

Complies with the following Directives:

2014/30/EU, 2011/65/EU & (EU)2015/863

Standards conform to

EN 60335-1, EN 60335-2-45, EN 62233, EN 55014-1, EN 55014-2



2020/08/26
Allen Ding

Deputy Chief Engineer, Testing & Certification
Positec Technology (China) Co., Ltd
18, Dongwang Road, Suzhou Industrial
Park, Jiangsu 215123, P. R. China

EN

14



www.worx.com

Copyright © 2019, Positec. All Rights Reserved.

AR01537700