



HOMEBASE

PORTABLE AIR
CONDITIONER 5000BTU

INSTRUCTION MANUAL

IMPORTANT: Please read these instructions before using the product and retain for future use.

HHGL Limited, MK9 1BA
HHGL (RO) Limited, D02 X576

SAFETY WARNINGS



Read this information carefully before installation or use of this product. Keep this manual with the product for future reference.

1. When using electrical appliances, basic precautions should always be followed to reduce the risk of fire, electric shock, burns and other injuries.
2. Please pay attention to the meaning of the icons in the manual, especially the flame symbol.
3. This appliance can be used by children aged from 8 years and above and persons with reduced physical, sensory or mental capabilities or lack of experience and knowledge, if they have been given supervision or instruction concerning use of the appliance in a safe way and understand the hazards involved.
4. Children shall not play with the appliance.
5. Cleaning and user maintenance shall not be made by children without supervision.
6. If the supply cord is damaged, it must be replaced by the manufacturer, its service agent or similarly qualified persons in order to avoid a hazard.
7. Indoor use only.
8. Do not use the unit in an area: near to source of fire; where oil is likely to splash; exposed to direct sunlight; where water is likely to splash.
9. Never insert your fingers into the air outlet. Take special care to warn children of these dangers.
10. Keep the unit upright while transporting and storing.

11. Before cleaning or moving the appliance, always turn off and disconnect the power supply.
12. All the air-conditioner sockets must comply with the local electric safety requirements. If necessary, please check it corresponds with requirements.
13. The appliance shall be installed in accordance with national wiring regulations.
14. Details of type and rating of fuses: 250V AC, 13A.
15. Do not pull, deform or modify the power supply cord, or immerse it in water. Pulling or misuse of the power supply cord can result in damage to the unit and cause electrical shock.
16. Servicing shall only be performed as recommended by the equipment manufacturer.
17. Maintenance and repair requiring the assistance of other skilled personnel, shall be carried out under the supervision of the person competent in the use of flammable refrigerants.
18. Do not stop the unit by pulling the plug from the power supply. Always use the on/off button to operate/switch off, before removing the plug from the power supply.
19. Turn off and unplug the unit if strange sounds, smells, or smoke comes from it.
20. Always plug the appliance into an earthed plug socket. In case of any damage, please turn off the switch, disconnect the power supply, and contact an authorised service centre for repair.
21. Do not use means to accelerate the defrosting process or to clean, other than those recommended by the manufacturer.

22. The appliance shall be stored in a room without continuously operating ignition sources. For example: Open flames, an operating gas appliance or an operating electric heater.
23. Be aware that refrigerants may be odourless.
24. This appliance contains R290 refrigerant gas. R290 is a refrigerant gas that complies with the European directives on the environment. Do not puncture any part of the refrigerant circuit.
25. Repairs must be performed based on the recommendation from the manufacturer.
26. Regarding the instructions for symbols displayed on unit, please kindly refer to page 5.
27. Always let the appliance rest for at least 2 hours after moving it from one location to another.

SAFETY RELATING TO REFRIGERANT R290:



Caution, risk of fire



Explanation of symbols displayed on the unit, (for units that adopt R290 Refrigerant only):

	<p>WARNING</p>	<p>This symbol shows that this appliance uses a flammable refrigerant. If the refrigerant leaks and is exposed to an external ignition source, there is a risk of fire.</p>
	<p>WARNING</p>	<p>This symbol shows that the operation manual should be read carefully.</p>
	<p>WARNING</p>	<p>This symbol shows that personnel handling this equipment should refer to the installation manual.</p>
	<p>WARNING</p>	<p>This symbol shows that information is available, such as the operating instructions or installation manual.</p>

Warning : Keep ventilation openings clear of obstruction.

Warning: The appliance should be stored in a well ventilated area, where the room size corresponds to the room area, as specified for operation. The required distance around the unit should be at least 30cm.

This appliance should be installed, operated and stored in a room with a floor area larger than 4m²

TECHNICAL SPECIFICATION

Cooling capacity	5000BTU /H
Model No.	FDP15-2021R5
Article No.	647445
Voltage	220 - 240V
Frequency	50Hz
Rated Input Power	575W
Rated Input Current	2.67A
Temp. Setting Range	16°C-31°C
Refrigerant	R290/75g
Noise Level	Less than 63dB(A)
Net Weight	18Kg
Product Dimensions (mm)	H685 x W330 x D280

ICON EXPLANATION



This appliance conforms to relevant directives of The European Community.



The product complies with the applicable UK directives.



This marking indicates that this product should not be disposed with other household waste. To prevent possible harm to the environment or human health from uncontrolled waste disposal, recycle it responsibly to promote the sustainable reuse of material resources. To return your used appliance, please use the return and collection systems or contact the store where the appliance was purchased. They can take this product for environmentally safe recycling.

PARTS DESCRIPTION

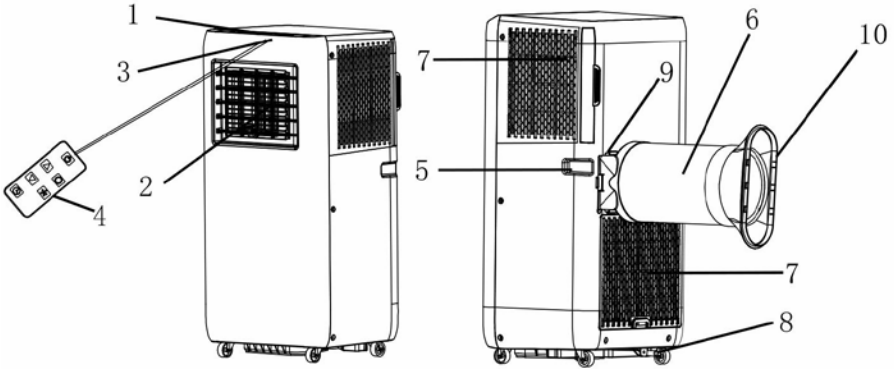

- | | |
|-------------------------|---------------------------------------|
| 1. Control panel | 6. Air exhaust hose |
| 2. Air outlet & louvers | 7. Air inlet and air filter |
| 3. Signal receptor | 8. Drain port (inserted by a stopper) |
| 4. Remote control | 9. Hose connector |
| 5. Handle | 10. Window adaptor |

REMOTE CONTROL

This unit has a remote control. 1 x CR2025 battery will be provided with the remote control. Before starting to use the remote control, remove the plastic protection from the battery. If you want to change the battery, please refer to the instructions behind the remote control. If it is not in use for a long time, please remove the battery from the remote control. The functions of the remote control buttons are below:

1. Power button
2. Mode button
3. Fan speed button
4. Temperature/timer increasing button
5. Temperature/timer decreasing button
6. Timer button

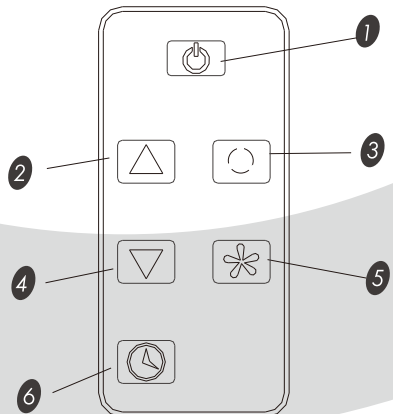

CONTROL PANEL

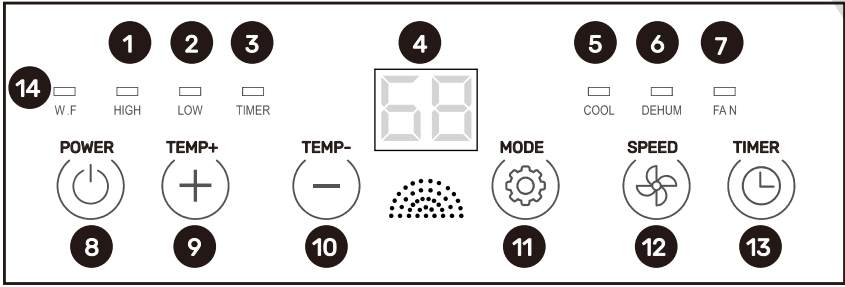

Control panel buttons and indicators

- | | |
|-----------------------------------|--------------------------------|
| 1. Fan speed indicator (high) | 8. Power button |
| 2. Fan speed indicator (low) | 9. Temperature up button |
| 3. Timer indicator | 10. Temperature down button |
| 4. Temperature/timer display | 11. Operation mode button |
| 5. Mode indicator (cooling) | 12. Fan speed button |
| 6. Mode indicator (dehumidifying) | 13. Timer button |
| 7. Mode indicator (fan) | 14. Water full indicator light |

ACCESSORIES

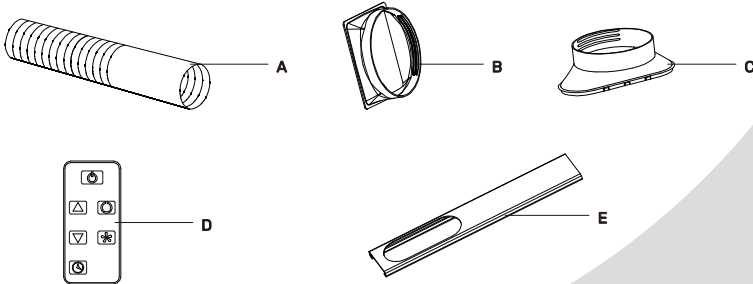

- | | |
|-----------------------------------|-------------------------------|
| A - Air exhaust duct | D - Remote control |
| B - Connector of air exhaust duct | E - Sets of bracket (A and B) |
| C - Window exhaust adaptor | |

INSTALLATION

Installing the window kit and appliance.

Your window kit has been designed to fit most standard horizontal and vertical window applications. However, for certain types of windows it may be necessary for you to improvise/modify some aspects of the installation procedure. If the window kit does not fit your window, please ask your technical/electrical specialist for advice. Before starting, ensure that the distance between the air outlet and the wall is at least 60 cm . The window height should not be less than 60 cm or greater than 120 cm.

Installing the exhaust hose and adapter

1. Extend the air exhaust hose by drawing out the two ends of the duct (Fig. 1). Please ensure that the unit is positioned in such a way that it can reach the window, door or venting hole in the wall.
2. **IMPORTANT!** Do not block the air intake with a protective grid or any other object.
3. Attach the air exhaust duct connector and the window exhaust adaptor (Fig. 2) on either side of the hose.

Fig. 1

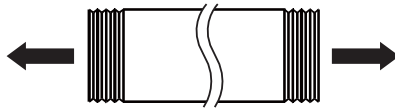
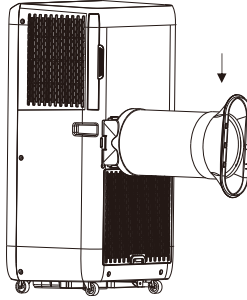

Fig. 2



Connect the connector of the air exhaust duct to the unit (Fig. 3)

Fig. 3



INSTALLING THE WINDOW KIT

1. Separate both sets of bracket (A and B).
2. Screw the wing nut through the B bracket. Leave 2/3mm of the free space.
3. Insert A bracket into B bracket according to arrowhead direction.

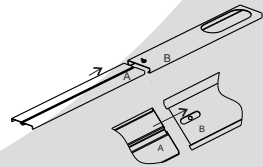
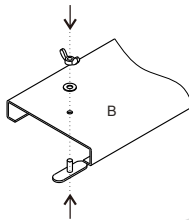
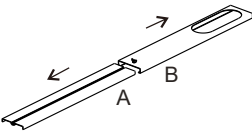

4. You can adjust A bracket up or down, according to the height of the window. Screw it until it is tight.



5. Install exhaust air duct & its accessories into the window kit according to the arrowhead direction.

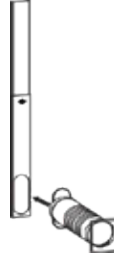

6. Open the window where you need to install the exhaust air duct, window kit and their accessories.

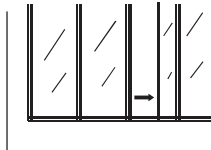

7. Install the exhaust air duct, window kit and their accessories through the window. Then close the window according to arrowhead direction in drawing, to press window kit tightly.

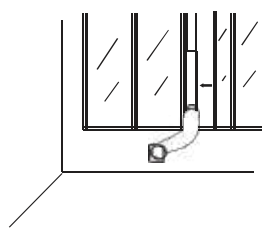

8. Connect the unit. Assembly is then complete.

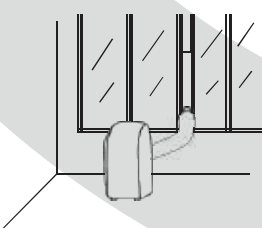

USING THE CONTROL PANEL

Switching the unit on/off

1. Plug in the unit. It will emit a long beep.
2. Press the power button [🔌] to turn on the unit. It will beep once. When you have finished using the air conditioner, press this button again. The unit will beep once.
3. The LED display will show the room temperature.

Selecting the operating mode

1. Press the operating mode button [⚙️] to select the desired mode.
2. Repeatedly press this button to cycle through the options, as shown below:

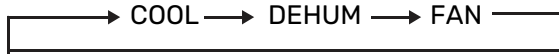

Cool mode

- When the room temperature is higher than set temperature, the compressor starts to run.
- When the room temperature is lower than set temperature, the compressor stops and upper fan operates at original set speed.

Dehumidify mode

- The fan will run at low speed, and the speed can't be adjusted.
- The unit adopts constant temperature in dehumidifying mode, and the adjustment of temperature is not effective.

Fan mode

- The fan runs at set speed, and the compressor does not run.
- Unable to set the temperature.

Adjusting the temperature

1. The temperature can be adjusted from 16°C to 31°C, in 1°C increments.
2. Press the [+] or [-] buttons to increase/decrease the temperature by one degree at a time.
3. Once you have reached the desired temperature, the display will show this temperature for approx. five seconds, and then switch to displaying the room temperature.

Adjusting the fan speed

Press the [] button to select the desired fan speed (low/high) in the order shown below:



Setting the timer

● AUTO ON:

1. To have the appliance automatically switch on after a predetermined amount of time, switch the appliance off.
2. While the appliance is switched off, press the timer button [].
3. The timer indicator light will switch on and flash.
4. Press the TEMP+ or TEMP- buttons to increase or decrease the set time. It will increase/decrease in 1 hour increments, and can be set between 1 and 24 hours. The time will appear on the display.
5. If no other buttons are pressed, the timer will automatically confirm. The timer indicator will remain illuminated steadily.
6. The appliance will automatically turn on once the set time has elapsed.

● AUTO OFF:

1. To have the appliance automatically switch off after a predetermined amount of time, switch the appliance on.
2. While the appliance is switched on, press the timer button [].
3. The timer indicator light will switch on and flash.
4. Press the TEMP + or TEMP - buttons to increase or decrease the set time. It will increase/decrease in 1 hour increments, and can be set between 1 and 24 hours. The time will appear on the display.
5. If no other buttons are pressed, the timer will automatically confirm. The timer indicator will remain illuminated steadily.
6. The appliance will automatically turn off once the set time has elapsed.

The appliance has a memory function: when the appliance is turned on it will return to the working mode before it turned off.

WATER FULL ALARM

Condensation water that forms during cooling will drop into an in-built drip tray. When the water level in the drip tray is getting too full, the “water full” indicator light will switch on, and after 5 minutes, the error code [E4] will appear on the screen. Should this error code appear during operation, proceed as follows:

1. Unplug the unit from the power supply.
2. Place a pan under the water drainage outlet at the bottom of the unit.
3. Remove the rubber stopper and drain all water out of the tray.
4. Alternatively, attach a water drain hose to the drainage outlet and lead the hose to the outside or into a tub or drain for water drainage.

PROTECTION

The protective device may be activated in the below cases. If these circumstances occur, the unit will switch off.

Cooling	Room temperature is above 43°C
	Room temperature is below 15°C
Dehumidifying	Room temperature is below 15°C

NOTE: If the air conditioner is operating in cooling or dehumidifying mode with a door or window open, when room relative humidity is above 80%, water mist may blow out of the outlet.

TROUBLESHOOTING GUIDE

If you experience problems with your portable air conditioner, or it appears not to be operating correctly, check the information below for solutions to common problems. If none of the solutions offered help you solve your problem, please contact your local store.

Trouble	Analysis
Does not run	<ul style="list-style-type: none">● If the over protector or fuse is blown. Please wait for 3 minutes and start again. If issue continues, try replacing the fuse.● If the protector is preventing unit from working. Please move protector device.● If battery in the remote control is exhausted. Please replace battery.● If the plug is not properly plugged in. Please check plug is fully inserted into the power supply.
Runs for a short while only	<ul style="list-style-type: none">● If the set temperature is close to room temperature. You can lower the set temperature.● If the air outlet is blocked by an obstacle. Remove the obstacle.
Water leak when moving	<ul style="list-style-type: none">● Didn't drain the water before moving.● The unit is on un-flat ground. Please re-positon on flat ground.
Does not run and water full indicator is illuminated	<ul style="list-style-type: none">● Pull out the rubber plug to drain water● If it is often in this state, please contact qualified service technical.
Appliance automatically stops	<ul style="list-style-type: none">● Timing shut down. Please re-set the timer.● Set temperature reached. Please adjust The "set" temperature, if required.

PLUG REPLACEMENT

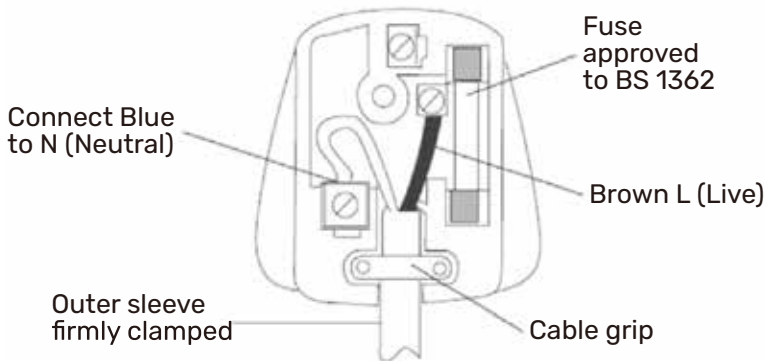

If you need to replace the fitted plug, then follow the instructions below.

⚠ WARNING! The wires in the mains lead are coloured in accordance with the following code:

Blue – Neutral
Brown – Live

As the colour of the wire in the mains lead of this appliance may not correspond with the coloured marking identifying the terminals in your plug, proceed as follows:

The blue wire must be connected to the terminal marked N or coloured black.

The brown wire must be connected to the terminal marked L or coloured red.

⚠ WARNING! Never connect live or neutral wires to the earth terminal of the plug. Only fit an approved BS 1363 or BS 1363/A plug and correctly rated BS 1362 13 Amp fuse. If in doubt, consult a qualified electrician.

NOTE: If a moulded plug is fitted and has to be removed, take great care in disposing of the plug and severed cable; it must be destroyed to prevent it being accidentally plugged into a power socket.

WARRANTY

This product is covered by a 2 year warranty.

The warranty covers any manufacturing defect in materials, workmanship and finish.

Any claim under this warranty must be made by going to your nearest Homebase store, taking your proof of purchase with you, and claims must be made within 2 years of the date of purchase.

We will offer you a free repair of the item where this is possible, or a replacement or a refund. Your statutory rights remain unaffected, in particular, any rights you may have under the Consumer Rights Act 2015.

This warranty is given by HHGL Limited, MK9 1BA; HHGL (ROI) Limited, D02 X576

Please note This warranty does not apply to products misused or neglected and only covers domestic use. It does not apply to commercial use of the product.