

OMARI SOFA SET SOFA

**HOMEBASE**  
**EDIT**

# INSTRUCTION MANUAL

IMPORTANT: Please read these instructions before using the product and retain for future use.

HHGL Limited, MK9 1BA;  
HHGL (ROI) Limited, D02 X576

## SAFETY & CARE ADVICE

Please read these instructions fully before starting assembly.

- This product is made from steel, which is strong but not unbreakable.
- Do not strike or place heavy weight on the sofa.
- Do not place hot items directly onto the sofa.
- Check you have all the components and tools listed on pages 2 and 3.
- Remove all fittings from the blister pack and separate them into their groups.
- Keep children and animals away from the work area, small parts could be a choking hazard.
- Make sure you have enough space to layout the parts before starting.
- Do not stand or put weight on the component parts and product, this could cause damage.
- Assemble the item as close to its final position (in the same room) as possible.
- Assemble on a soft level surface to avoid damaging the unit or your floor.
- Dispose of all packaging carefully and responsibly.
- Only clean using a damp cloth and mild detergent, do not use bleach or abrasive cleaners.
- From time to time check that there are no loose part on this unit.
- This product should not be discarded with household waste.
- Take to your local authority waste disposal centre.

## IMPORTANT INFORMATION

If the parts are missing, broken, damaged, or worn, stop using the product and contact your local store.

Do not use this table unless all bolts and screws are firmly secured.

At least every 4 months, check all bolts and screws to ensure they are tight.

Failure to follow these warnings could result in serious injury.

## COMPONENTS-PARTS

Please check you have all components listed below. If you have any missing or damaged components, please contact your local store.

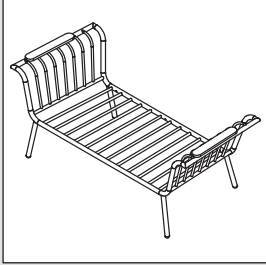

Sofa seat frame x 1

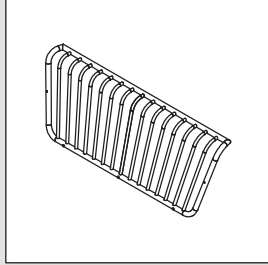

Sofa back frame x 1

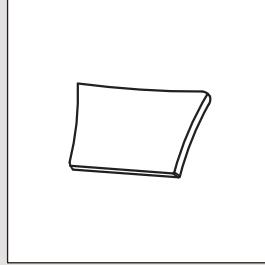

Back cushion x 2

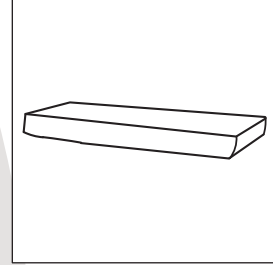

Seat cushion x 1

## COMPONENTS-FITTINGS

Please check you have all fittings listed below. If you have any missing or damaged fittings, please contact your local store.

Note: The quantities below are the correct amount to complete the assembly. In some cases, more fittings may be supplied than required.

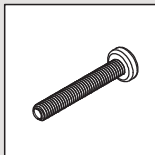

Screws M6 x 40mm x 5

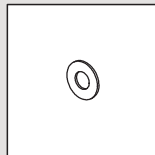

Washers x 5

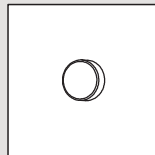

Caps x 5

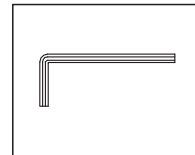

Allen key x 1

Keep this page with these instructions for future reference.

**RULER - USE THIS RULER TO HELP CORRECTLY IDENTIFY THE SCREWS**



# ASSEMBLY INSTRUCTIONS

## Step 1

Attach seat frame (1) to the back frame (2), using screw (A), washer (B) for the seat part.  
Note: Do not fully tighten all the screws until assembly is complete.

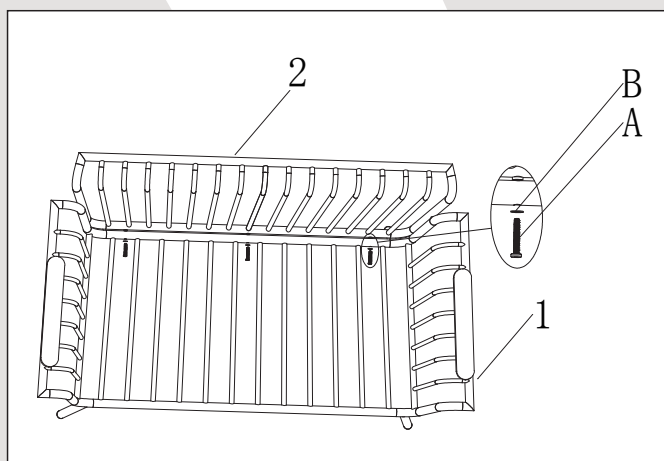

## Step 2

Using the using screw (A), washer (B) fix the back part as indicated on the diagram.  
Hand tighten the screws.

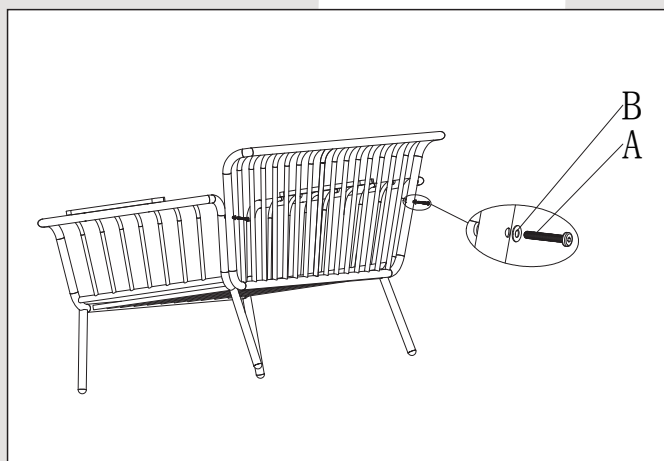

## Step 3

Cover all screw heads with cap (C).

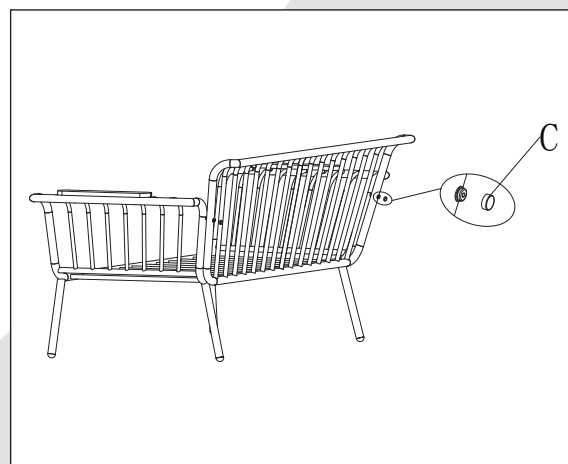
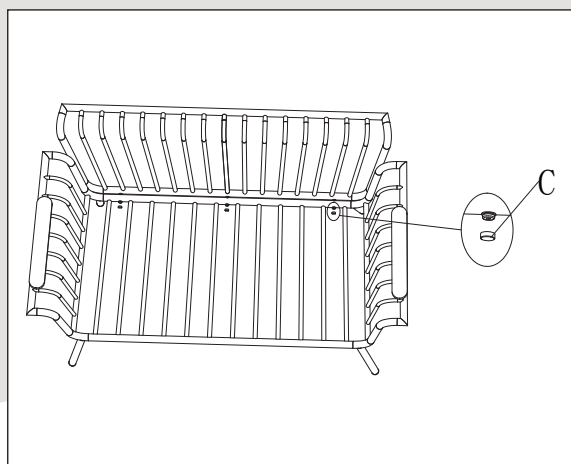

Keep this page with these instructions for future reference.

Step 4

Put the back cushion (3) and seat cushion (4) into the frame.

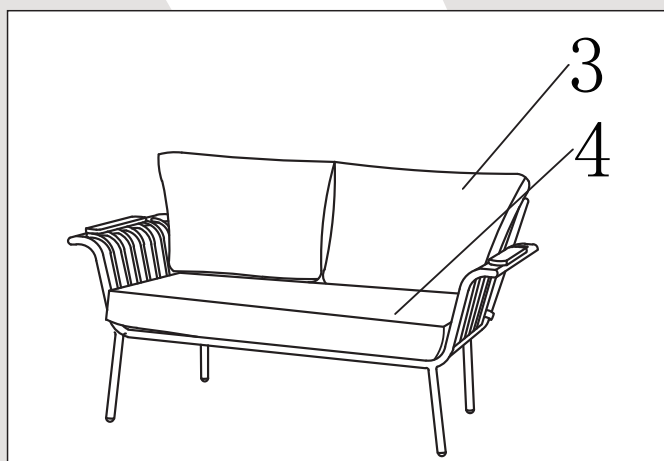

Step 5

Your sofa is now ready to use.

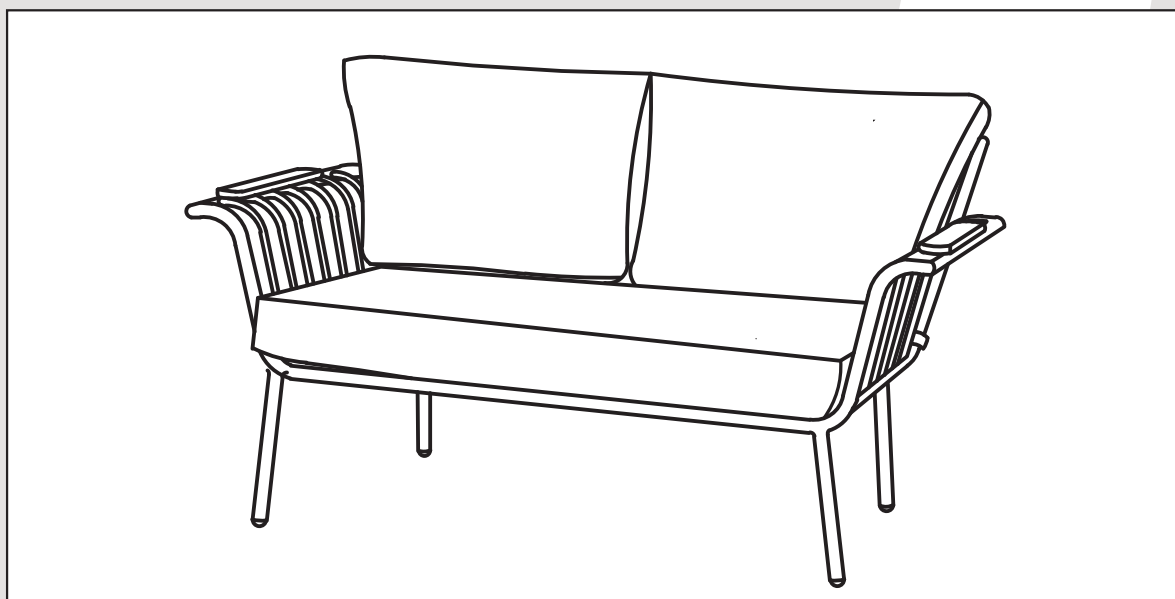

ASSEMBLY COMPLETE

Keep this page with these instructions for future reference.