

POWERBASE

25cm 20V Cordless
Grass Trimmer 644534

Instruction Manual

IMPORTANT!
Please read these
instructions fully before
starting assembly.

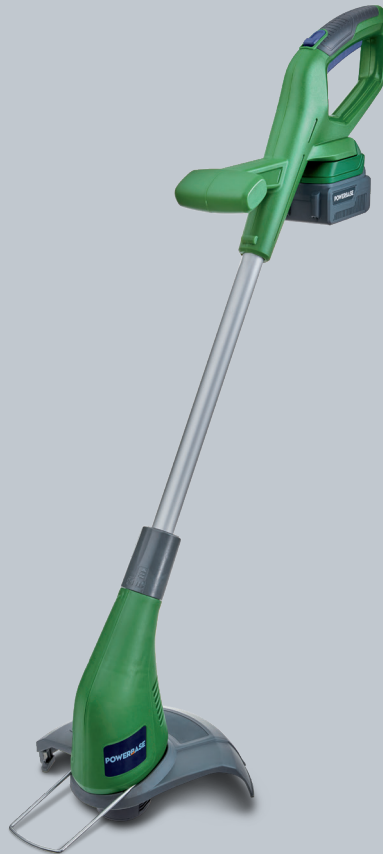

These instructions contain important information that will help you get the best from your product, ensuring it is assembled correctly and safely. If you need help or have damaged or missing parts, call the Customer Helpline on 01904 727 509.

Contents

General safety warnings	3
Intended use	11
Warning symbols	12
In the box	15
Assembly	16
Operation	20
Maintenance and storage	23
Troubleshooting	24
Technical data	25
Disposal	27
Getting help	27
Warranty	27

General Safety Warnings

Safety warnings



WARNING! Read all safety warnings and instructions.

Failure to follow the warnings and instructions may result in electric shock, fire and/or serious injury.



WARNING! Read all safety warnings and instructions designated by the  symbol.

Save all warnings and instructions for future reference.

The term 'power tool' in the warnings refers to your mains-operated (corded) power tool or battery-operated (cordless) power tool.

Work area safety

- **Keep the work area clean and well lit.** Cluttered or dark areas invite accidents.
- **Do not operate power tools in explosive atmospheres,** such as in the presence of flammable liquids, gases or dust. Power tools create sparks which may ignite the dust or fumes.
- **Keep children and bystanders away while operating a power tool.** Distractions can cause you to lose control.

Personal safety

- **Use common sense when operating a power tool. Do not use a power tool while you are tired or under the influence of drugs, alcohol or medication.** A moment of inattention while operating power tools may result in serious personal injury.
- **Use Personal Protective Equipment (PPE). Always wear eye protection.** Protective equipment, such as a dust mask, non-skid safety shoes, hard hat, or hearing protection used for appropriate conditions, will reduce personal injuries.
- **Prevent unintentional starting. Ensure the switch is in the off-position before connecting to a power source and/or battery pack, picking up or carrying the tool.** Carrying power tools with your finger on the switch or energising power tools that have the switch on invites accidents.
- **Remove any adjusting key or wrench before turning the power tool on.** A wrench or a key left attached to a rotating part of the power tool may result in personal injury.
- **Do not overreach. Keep proper footing and balance at all times.** This enables better control of the power tool in unexpected situations.
- **Dress properly. Do not wear loose clothing or jewellery. Keep your hair, clothing and gloves away from moving parts.** Loose clothes, jewellery or long hair can be caught in moving parts.

- **If devices are provided for the connection of dust extraction and collection facilities, ensure these are connected and properly used.** Use of a dust collection device can reduce dust-related hazards.

Power tool use and care

- **Do not force the power tool. Use the correct power tool for your application.** The correct power tool will do the job better and safer at the rate for which it was designed.
- **Do not use the power tool if the switch does not turn it on and off.** Any power tool that cannot be controlled with the switch is dangerous and must be repaired.
- **Disconnect the plug from the power source and/or the battery pack from the power tool before making any adjustments, changing accessories, or storing power tools.** Such preventive safety measures reduce the risk of starting the power tool accidentally.
- **Store idle power tools out of the reach of children and do not allow persons unfamiliar with the power tool or these instructions to operate the power tool.** Power tools are dangerous in the hands of untrained users.
- **Maintain power tools. Check for misalignment or binding of moving parts, breakage of parts and any other condition that may affect the power**

tools operation. If damaged, have the power tool repaired before use.

Many accidents are caused by poorly maintained power tools.

- **Keep cutting tools sharp and clean.** Properly maintained cutting tools with sharp cutting edges are less likely to bind and are easier to control.
- **Use the power tool, accessories and tool bits, etc., in accordance with these instructions, taking into account the working conditions and the work to be performed.** Use of the power tool for operations different from those intended could result in a hazardous situation.

Servicing

Have your power tool serviced by a qualified repair person using only identical replacement parts. This will ensure that the safety of the power tool is maintained.

Grass trimmer safety warnings

**IMPORTANT
READ CAREFULLY BEFORE USE
KEEP FOR FUTURE REFERENCE**

Training

- Read the instructions carefully. Be familiar with the controls and the correct use of the trimmer.

- Never allow children or people unfamiliar with these instructions to use the machine. Local regulations can restrict the age of the operator.
- Keep in mind that the operator or user is responsible for accidents or hazards occurring to other people or their property.

Preparation

- Before use, check the supply and extension cord for signs of damage or ageing. If the cord becomes damaged during use, disconnect the cord from the supply immediately. **DO NOT TOUCH THE CORD BEFORE DISCONNECTING THE SUPPLY.** Do not use the machine if the cord is damaged or worn.
- Before use, always visually inspect the machine for damaged, missing or misplaced guards or shields.
- Never operate while people, especially children or pets, are nearby.

Operation

- Keep supply and extension cords away from cutting means.
- Wear eye protection and suitable shoes while operating the machine.
- Avoid using the machine in bad weather conditions especially when there is a risk of lightning.
- Use the machine only in daylight or good artificial light.

- Never operate the machine with damaged guards or shields, or without guards or shields in place.
- Only switch on the motor when the hands and feet are away from the cutting means.
- Always disconnect the machine from the power supply (i.e. remove the plug from the mains, remove the disabling device or removable battery):
 - a) whenever the machine is left unattended;
 - b) before clearing a blockage;
 - c) before checking, cleaning or working on the machine;
 - d) after striking a foreign object;
 - e) whenever the machine starts vibrating abnormally.
- Take care against injury to feet and hands from the cutting means.
- Always ensure that the ventilation openings are kept clear of debris.
- Do not touch moving hazardous parts before the machine is disconnected from the mains and the moving hazardous parts have come to a complete stop.

General safety warnings for battery chargers



WARNING! This machine is not intended for use by persons (including children) with reduced physical, sensory or mental capabilities, or lack of experience and knowledge, unless they have been given supervision or instruction concerning the use of the appliance by a person responsible for their safety.



WARNING! Children should be supervised to ensure that they do not play with the machine.

- Before charging the battery, read all the instructions carefully.
- After charging, disconnect the battery charger from the mains supply. Then remove the chassis connection and then the battery connection.
- Do not charge a leaking battery.
- Do not use chargers for works other than those for which they are designed and intended.
- Before charging, ensure your charger matches the local AC supply.
- For indoor use. DO NOT expose to rain. The charging device must be protected from moisture.
- Do not use the charging device in the open.
- Do not short out the contacts of the battery or charger.

- Respect the polarity (+/-) when charging.
- Do not open the unit and keep out of the reach of children.
- Do not charge the batteries of other manufacturers or ill-suited models.
- Ensure that the connection between the battery charger and battery is correctly positioned, and is not obstructed by foreign bodies.
- Keep the battery chargers slots free of foreign objects and protect it from dirt and humidity. Store in a dry and frost-free place.
- When charging batteries, ensure that the battery charger is in a well-ventilated area and away from flammable materials. Batteries can get hot during charging. Do not overcharge any batteries. Ensure that batteries and chargers are not left unsupervised during charging.
- Do not attempt to recharge non-rechargeable batteries, as they can overheat and break.
- Longer life and better performance can be obtained if the battery pack is charged when the air temperature is between 18°C and 24°C. Do not charge the battery pack in air temperatures below 0°C, or above 45°C. This is important as it can prevent serious damage to the battery pack.
- Only charge a battery pack of the same model provided by the manufacturer or different models recommended by them.

Safety warnings for battery packs

- Do not dismantle, open or shred cells or battery packs.
- Do not short-circuit a battery pack. Do not store battery packs haphazardly in a box or drawer where they may short circuit each other, or be short-circuited by conductive materials.

Intended Use

This Li-ion cordless grass trimmer is intended for cutting weeds, grass or similar soft vegetation in areas that are hard to reach, e.g. under bushes, on slopes and hedges. It may not be used to work on unusually thick, dry or wet grass, e.g. pasture grass, or to shred leaves.

For safety reasons, it is essential to read this entire instruction manual before first operation and to observe all the instructions herein.

This product is intended for private domestic use only, not for any commercial trade use. It must not be used for any purposes other than described in this manual.

Warning Symbols

The purpose of safety symbols is to attract your attention to any possible dangers. The safety symbols and their explanations deserve your careful attention and full understanding. The symbol warnings do not, by themselves, eliminate any danger. The instructions and warnings they give are no substitute for proper accident prevention measures.



WARNING: Be sure to read and understand all safety instructions within this operator's manual, including all safety alert symbols such as '**DANGER**', '**WARNING**', and '**CAUTION**' before using this tool. Failure to follow all instructions listed below may result in electric shock, fire and/or serious personal injury.

SAFETY ALERT SYMBOLS: Indicate **DANGER**, **WARNING**, or **CAUTION**. May be used in conjunction with other symbols or pictographs.

Symbol meanings



Warning!



This is a warning symbol. This symbol is used throughout the instruction manual whenever there is a risk of personal injury. Ensure that these warnings are read and understood at all times.
Read the instruction manual before operating this machine.



Wear eye protection.



Wear ear protection.



Wear a dust mask.



Do not expose to rain.



Guaranteed sound power level.



Keep bystanders away.



Remove the battery pack before any adjustment or maintenance.



The product complies with the applicable European directives and an evaluation method of conformity for these directives was done.



The product complies with the applicable UK directives and an evaluation method of conformity for these directives was done.



WEEE symbol. Waste electrical products should not be disposed of with household waste. Please recycle where facilities exist. Check with your local authority or local store for recycling guidelines.

Warning symbols on the battery pack



To reduce the risk of injury, the user must read the instruction manual carefully.



Do not throw into water.



Do not dispose of batteries in a fire. They will explode and cause injury.



Do not subject the battery to strong sunlight over long periods of time. Do not leave on a heater (max. 45°C).



Batteries contain Li-ion. Do not dispose of waste batteries in domestic waste. Contact your local authority to find out how to dispose of batteries.



The product complies with the applicable European directives and an evaluation method of conformity for these directives was done.



The product complies with the applicable UK directives and an evaluation method of conformity for these directives was done.



WEEE symbol. Waste electrical products should not be disposed of with household waste. Please recycle where facilities exist. Check with your local authority or local store for recycling advice.

Warning symbols on the charger



To reduce the risk of injury, the user must read the instruction manual carefully.



The charger is for indoor use only.



Class II equipment.

T3.15A



Protective 3.15 A limited.



WEEE symbol. Waste electrical products should not be disposed of with household waste. Please recycle where facilities exist. Check with your local authority or local store for recycling advice.



The product complies with the applicable European directives and an evaluation method of conformity for these directives was done.



The product complies with the applicable UK directives and an evaluation method of conformity for these directives was done.

In the Box

Parts

- A. On/off switch
- B. Safety switch lock
- C. Front handle
- D. Tube
- E. Edging switch
- F. Motor housing
- G. Protection guard
- H. Line blade
- I. Plant protector
- J. Spool head
- K. Charger
- L. Battery pack
- M. Red light
- N. Green light

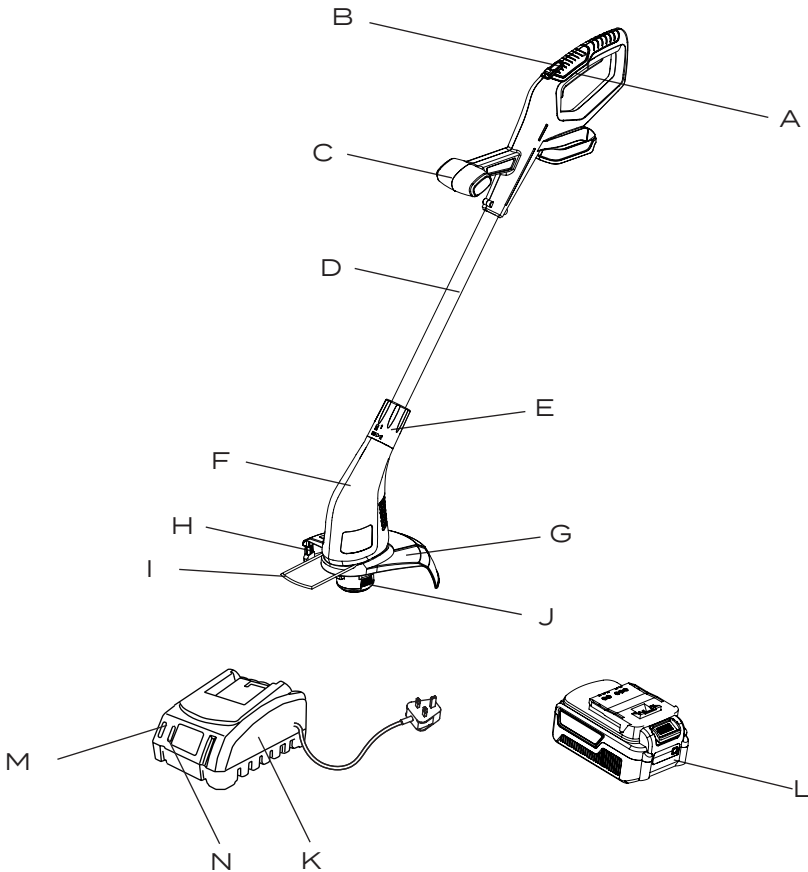

Assembly



WARNING: Ensure the battery pack is disconnected from the grass trimmer before making the assembly.

Charging the battery pack



WARNING! The charger and battery pack are specifically designed to work together so do not attempt to use any other devices. Never insert or allow metallic objects into your charger or battery pack connections; an electrical failure and hazard will occur.

The battery needs to be charged before first use and whenever it fails to produce sufficient power on jobs that were easily done before.



WARNING! NEVER LEAVE THE BATTERY AND CHARGER UNATTENDED WHEN CHARGING THE BATTERY.

This product comes with a lithium-ion battery pack. Lithium-ion batteries don't lose charge when not in use, and don't lose charging capacity overtime. Nevertheless, it is best practice to charge the battery when empty or insufficient to do the job.

Charging procedure

1. Connect the charger (11) to a power supply. The left red light (13) will illuminate.
2. Slide the battery pack into the charger, make sure the battery pack (12) is fully seated in position. the left red light is on and the right green light (14) is flashing to indicate the charging is on going.
3. When charging is complete, the left light is off and the right green light is on.
4. Once the battery is fully charged, disconnect the charger from the mains and remove the battery pack from the charger.

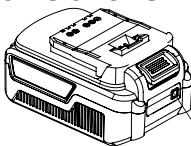

12

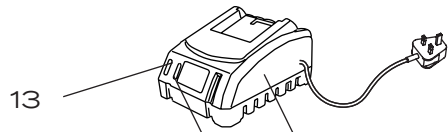

13

14

11

Checking battery capacity

Press the battery display button to check the capacity of the battery pack. The battery pack capacity will be shown on the battery's digital display. If 100% is shown, the battery is fully charged and if 50% is shown, the battery is half charged.

Charge the battery pack before operating, when it is less than half-charged.

Important charging notes

1. Never allow the battery to completely discharge before recharging. The battery pack should be placed on the charger whenever the battery pack is noticeably running down, or the tool no longer performs a task it previously performed.
2. Avoid conducting short charges. Make sure that the battery is fully charged each time by allowing the charger to complete its full charging cycle.
3. Avoid allowing loose items like screws or nails, etc., to be stored with battery packs, as these or similar items can short battery packs and cause a fire or explosion.
4. Always unplug the charger when not in use and store in a dry and secure place.
5. Avoid charging or storing your battery in temperatures below 5°C and above 45°C.
6. After use, allow the battery pack to cool down for approximately 30 minutes before attempting to recharge.



WARNING! Don't allow any liquid to get inside the charger; electric shock may result. To facilitate the cooling of the battery pack after use, avoid placing the charger or battery pack in a warm environment, such as in a metal shed or an uninsulated trailer.



WARNING! Never attempt to open the battery pack for any reason. If the plastic housing of the battery pack breaks or cracks, return it to a service centre for recycling; do not put it into further use.

Assemble the handle

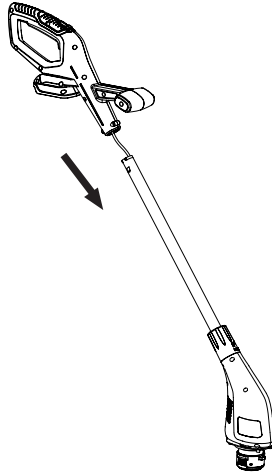

Insert the lower aluminium rod into the main handle body firmly.

Note: Make sure that the handle is firmly locked in place. Do not try to remove these pieces after connecting.

Plant protector assembly

Assemble the plant protector into the slot on the motor housing.

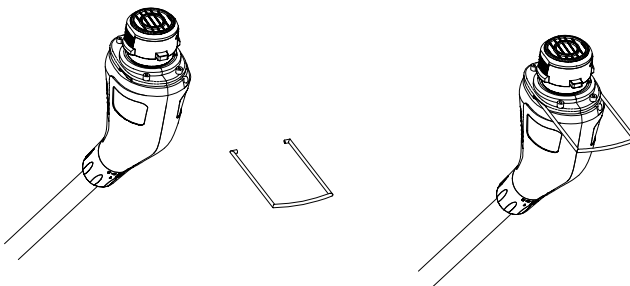

Assemble the guard

1. Remove four mounting screws from the motor housing.

Note: They are pre-mounted on the motor housing by the factory to help the end-user find them quickly and indicate to the end-user where these four screws should be used.

2. Put the safety guard onto the motor housing.
3. Fix the safety guard in place by using these four screws.

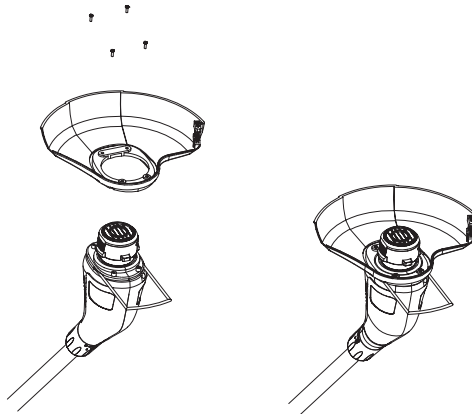

Operation

Installing the battery pack



WARNING! Always release the on/off trigger before insertion or removal of the battery pack.

1. Keep the battery pack in line with the slot on the device.
2. Push it forward until it reaches the bottom. Before starting, make sure the battery pack is firmly locked in place.
3. To remove the battery pack: Depress button (A) on the end of the battery pack, and then remove the pack from the tool.

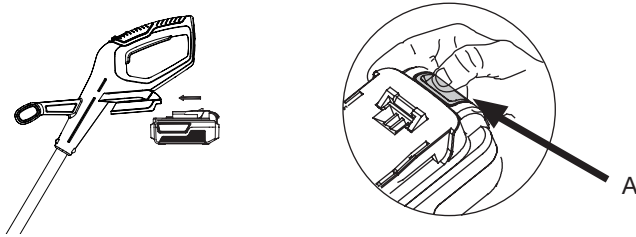

Switching on/off

1. Push safety switch forward and press the on/off switch to turn the product on.
2. Release the on/off switch to turn the product off.

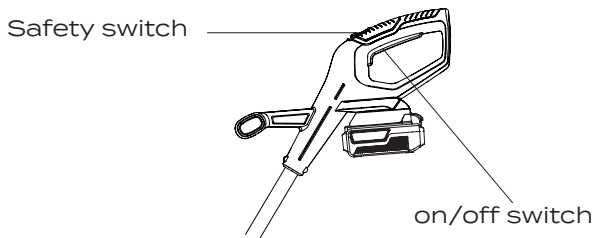

Operating the edging function



WARNING! Adjust the trimmer head working position only when the product is switched off and the cutting device is at a complete stop!

NOTE! This grass trimmer can be set to edge trimming for better cutting performance.

Pull the edging switch away from the motor housing as indicated in step 1, then place both hands on the tube and motor housing, and rotate 180 degrees to select edge cutting mode.

NOTE! When using the edge cutting mode, always make sure the motor housing is clicked into the correct position, and the edging switch clicks firmly, otherwise it may not operate correctly.

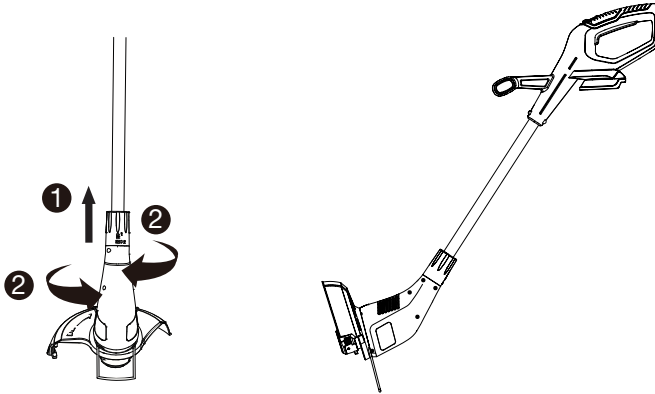

Automatic line feeding

The equipment features a fully automatic single line-feed system.

The lines will automatically elongate every time you turn on the machine. To support proper line elongation, ensure that the coil has stopped moving completely before turning on the trimmer again.

The lines are automatically cut to the correct length by the line cutter.

Cutting guide



WARNING! Always wear eye protection (PPE). Never lean over the trimmer head. Stones or debris can bounce or be thrown into the eyes and face, and cause blindness or other serious injury.

When operating the unit:

Hold the front handle with one hand and auxiliary handles with the other hand.

Keep the unit below waist level. Work only from your right to your left to ensure debris is thrown away from you. The guard should face you, protecting you from debris.

Do not switch the machine on with the cutting head on or near material to be cut. Ensure the cutting line is at full speed before contacting the grass.

Use the trimmer at an angle of approximately 15° to the working area.

In a controlled manner, swing the trimmer head from side to side.

If the grass is very long, cut it in stages rather than trying to cut it all in one go. Do not overload your trimmer; take small cuts, this will keep the machine operating at high speed and improve the cutting efficiency.

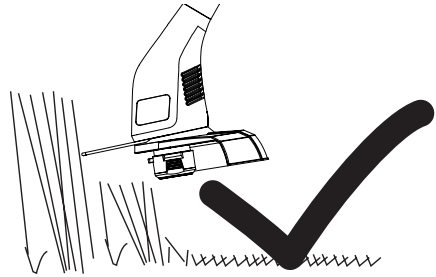
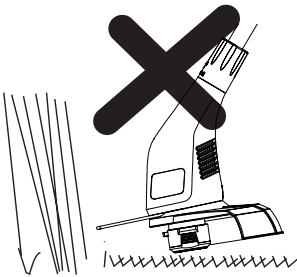

Maintenance and Storage

Replace the spool



WARNING!

Before replacing the spool, always switch off the machine and take out the battery pack!

RISK OF INJURY! Cutting elements continue to rotate after the motor is switched off. Do not try to stop the cutting device (nylon blade) with your hands. Always let it come to a stop by itself.

Remove the spool assembly from the trimmer. To do so, hold the outer ribbed part of the assembly with one hand, while pushing down and turning the spool head with the other to unlock it. The spool carrier and spool will now disassemble easily.

Note: There is a spring inside the head that could easily be lost. Ensure that it is put in a safe place.

Choose either Option 1 or Option 2 below for spool or line replacement.

Option 1: Replacing the spool

Insert the line from the replacement spool through the eyelet in the spool carrier and slide the spool into it.

Making sure to insert the spring, assemble the spool and spool carrier back onto the trimmer. To do so, push the head on and turn it clockwise until it locks.

To test if the line is advancing properly, push the button with your thumbs while pulling the line with your fingers. It should advance freely.

Option 2: Replacing the line



WARNING!

Please use 1.2mm or 1.4mm diameter line only.

Line for your trimmer is available at an extra cost from your local store or the customer support service. Replace the line, as follows:

Insert one end of the line into the hole in the spool, about 3mm.

Wind the line tight and evenly onto the spool in the direction of the arrow until the line builds up to the notches in the spool rim. Do not overfill the spool. The spool holds about 6.5m of line.

Cleaning and storage

After use, remove the battery pack from the trimmer.

When not in use, store the machine in a dry, safe place, out of the reach of children.

Use only manufacturer recommended replacement parts and accessories.

To clean the tool, remove the battery pack and use a mild soap solution and a damp cloth to clean it. Do not immerse the tool in water or spray it with a hose. Do not allow any liquid to get inside it. Do not clean with a pressure washer.

Troubleshooting

Suspected malfunctions are often due to causes that the user can fix themselves. Therefore, check the product using this section. In most cases the problem can be solved quickly.



WARNING! Only perform the steps described within these instructions! All further inspection, maintenance and repair work must be performed by an authorised service centre, or a similarly qualified specialist if you cannot solve the problem yourself! Gloves and appropriate protective clothing must be worn when performing these actions.

Fault	Possible cause	Solution
Line trimmer fails to start	The battery pack is not attached to the line trimmer	Attach the battery pack to the line trimmer
	No electrical contact between the trimmer and battery	Remove battery, check contacts and reinstall the battery pack
	The battery pack is depleted	Charge the battery pack
	The lock-off lever and trigger are not depressed simultaneously	Press down the lock-off lever and hold it, then depress the trigger to turn on the line trimmer

Fault	Possible cause	Solution
Line trimmer stops while cutting	The motor shaft or trimmer head is bound with grass	Stop the trimmer, remove the battery, and remove the grass from the motor shaft and trimmer head
	The motor is overloaded	Remove the trimmer head from the grass. The motor will recover to work as soon as the load is removed. When cutting, move the trimmer head in and out of the grass to be cut and remove no more than 20cm of length in a single cut
	The battery pack or line trimmer is too hot	Allow the battery pack or trimmer to cool until the temperature drops below 50°C
Trimmer head will not advance line	The motor shaft or trimmer head is bound with grass	Stop the trimmer, remove the battery, and remove the grass from the motor shaft and trimmer head
	There is not enough line on the spool	Remove the battery and replace the cutting line

Technical Data

Property	Value
Model no.	GT 25B
Voltage	20V d.c.
Battery type	Lithium-ion
No load speed	8000/min
Cutting diameter	25cm
Net weight	2.7kg
Battery pack model	BOP-SPO6-2OZJ
Battery capacity	20v d.c. 5.0Ah
Charging time	2.0 hours
Battery charger model	BOQ-SPO6-2OZB
Input	220-240V~ 50/60Hz 65W
Output	20V d.c 2.4A

Noise and vibration data

A weighted sound pressure 66.5dB(A) K_{pA} : 2.9dB(A)

A weighted sound power: 86dB(A)

The guaranteed sound power level: 96dB(A)

Wear ear protection

Typical weighted vibration 2m/s^2 $K=1.5\text{m/s}^2$



WARNING: The sound values have been determined according to the noise test code given in EN 50636-2-91, using the basic standards EN ISO 11094 and EN ISO 3744.

The sound intensity level for the operator may exceed 80dB(A) and ear protection measures are necessary.

The declared vibration value (according to EN 60335-1) has been measured in accordance with a standard test method, and may be used for comparing one product with another. The declared vibration value may also be used in a preliminary assessment of exposure.

Depending on the actual use of the product, the vibration values can differ from the declared total. Adopt proper measures to protect yourself against vibration exposures. Take the whole work process into consideration, including times the product is running under no load or switched off.



WARNING! This tool may cause Hand-Arm Vibration Syndrome (HAVS) if its use is not adequately managed.

Preventative measures include, among others, regular maintenance and care of the product and cutting attachments, keeping hands warm and periodical breaks, as well as proper planning of work processes.

Disposal

The grass trimmer and its accessories are made of various recyclable materials. Dispose of the grass trimmer in accordance with your local recycling regulations.

Getting Help

Our dedicated UK-based customer helpline is open 7 days a week to assist you with assembly, parts queries and technical support. We are open during office hours but you can always send an email via **support@coreservice.co.uk**. Our experts are here to get you back enjoying your garden in no time.

For useful assembly, starting and maintenance videos, and for ordering spares, please visit **www.coreservice.co.uk**.

Using our helpline does not affect your statutory rights.

Warranty

This product is covered by a 3 year warranty.

The warranty covers any manufacturing defect in materials, workmanship and finish.

Any claim under this warranty must be made by going to your nearest Homebase store, taking your proof of purchase with you, and claims must be made within 3 years of the date of purchase.

We will offer you a free repair of the item where this is possible, or a replacement or a refund. Your statutory rights remain unaffected, in particular, any rights you may have under the Consumer Rights Act 2015.

This warranty is given by HHGL Limited, MK9 1BA; HHGL (ROI) Limited, DO2 X576.

Please note: This warranty does not apply to products misused or neglected and only covers domestic use. It does not apply to commercial use of the product. The warranty period for the battery pack and charger is 1 year.