

Hiya,

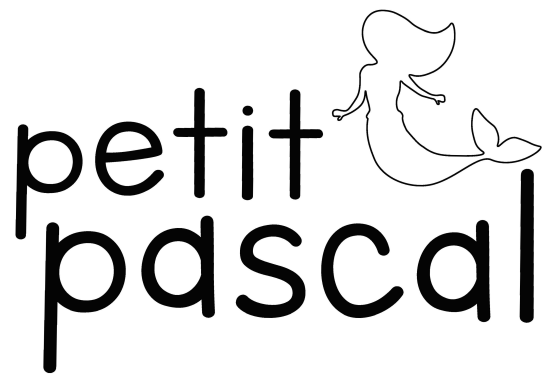

Meet your new

Petit Pascal

Mermaid Radiator Cover

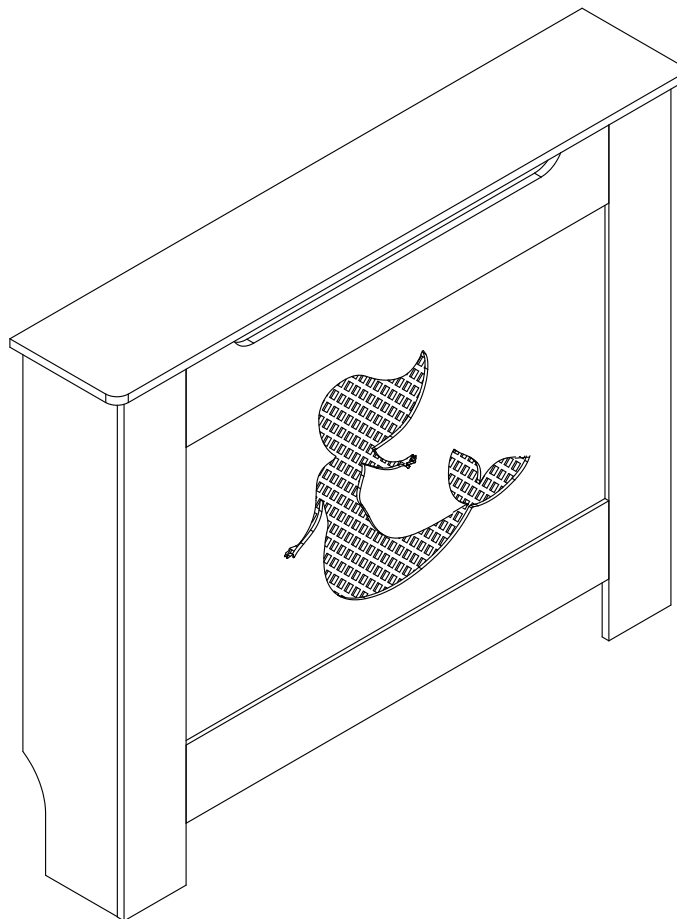

#### Customer Helpline

If you need help or have damaged or missing parts, please call our customer helpline 0121 776 5720 and quote our product reference code:

200 . 96 . 101 M

please keep a copy of these assembly instructions for future reference



Welcome to the  
LLOYD PASCAL  
family established  
in 1919



We would love to see your new product in its new home. **Share your experience** by taking a picture of your **Petit Pascal** product and **post it on social media tagging** **@petitpascaluk @lloydpascal** **#welovehome #LPfurniture #LPHome**

**Connect with us:** Using your mobile camera, scan the QR code and visit our website **[www.petitpascal.co.uk](http://www.petitpascal.co.uk)**

**Are you loving/satisfied with your new purchase?**

**Yes:** That's perfect. It would make our day if you could leave us a review on our social media channels. Your feedback will help us develop even better products to love.

**No:** If for any reason your enjoyment of our product is on Hold then **let the retailer** that you purchased your item from know **or contact us** and we will resolve your issue as quickly as possible.



# Safety and Care Advice

---

## IMPORTANT, RETAIN FOR FUTURE REFERENCE: READ CAREFULLY.

- Keep children and animals away from the work area, small parts could choke if swallowed.

- Make sure you have enough space to layout the parts before starting.

- This product has been constructed to be used in the domestic environment only and not for commercial purposes.

- Assemble the item as close to its final position (in the same room) as possible.

- Assemble on a soft level surface to avoid damaging the unit or your floor.



- We do not recommend the use of power drill/drivers for inserting screws as this could damage the unit. Only use

hand screwdrivers.

- Parts of the assembly will be easier with 2 people.

- Dispose of all packaging carefully and responsibly.

## Care and maintenance

---

- Only clean using a damp cloth and mild detergent. Do not use abrasive cleaners.

- From time to time check that there are no loose screws, nuts or bolts. If there are please re-tighten.

- This product should not be discarded with household waste. Take to your local authority waste disposal centre.

# Fittings

---

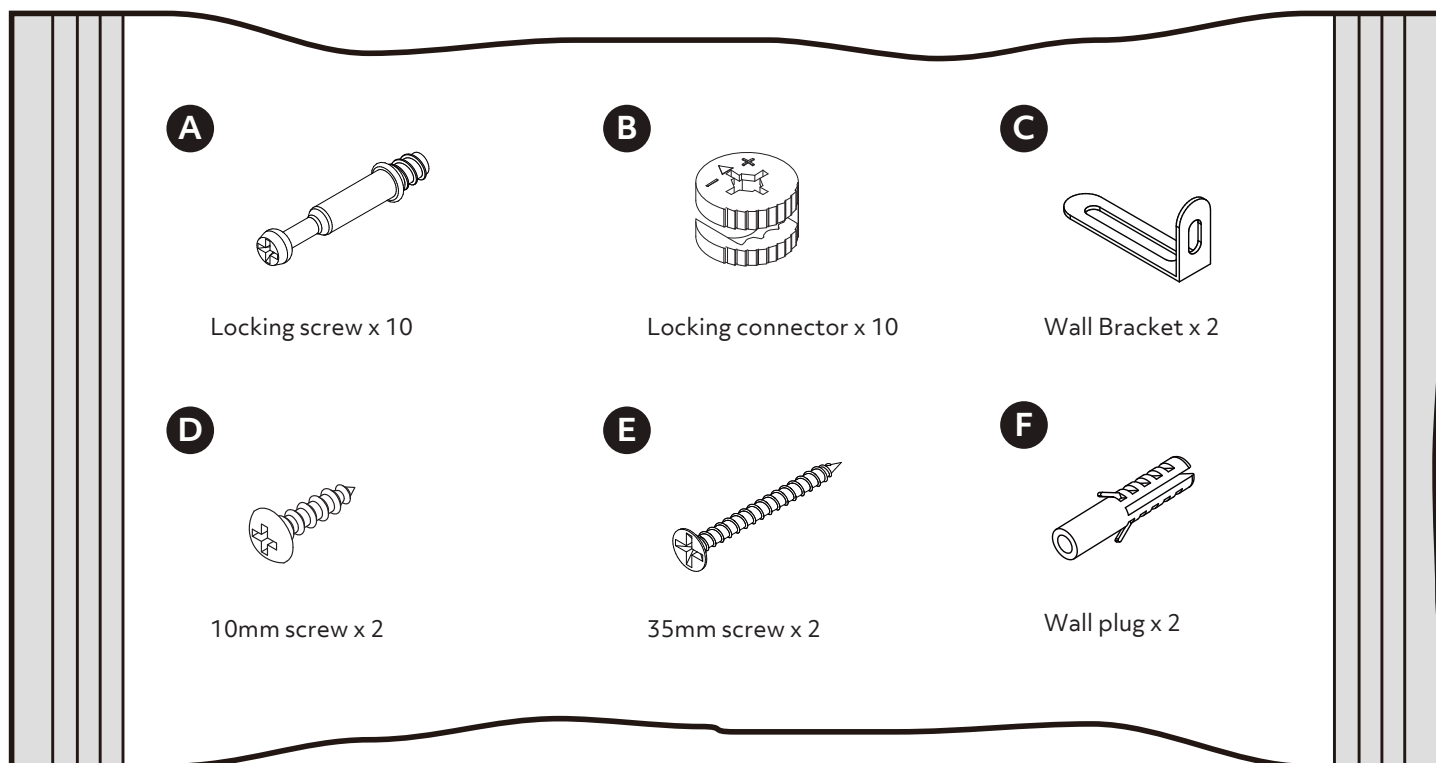

# Tools required

---

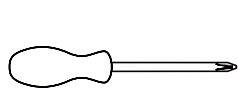

Phillips screwdriver  
(small & medium)

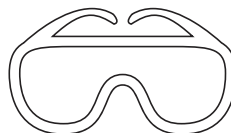

Eye protection  
(when using a hammer or  
glue)

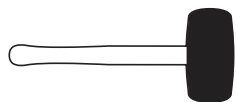

Mallet

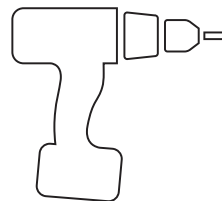

Power drill

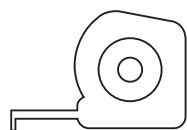

Ruler/tape  
measure

# panels

---

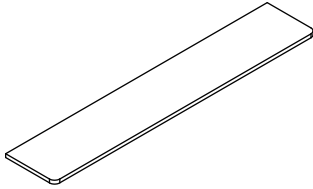

**1** Top panel x 1  
(101.5(w)cm x 19(d)cm)



**1** Left side panel x 1  
(80.5(h)cm x 17(d)cm)

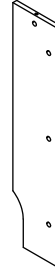

**3** Right side panel x 1  
(80.5(h)cm x 17(d)cm)

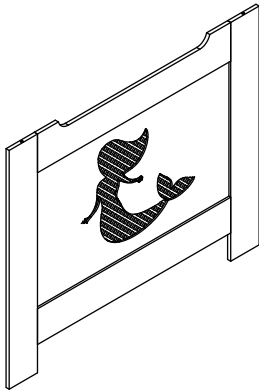

**1** Face panel x 1  
(96.5(w)cm x 80.5(h)cm)

# Step 1

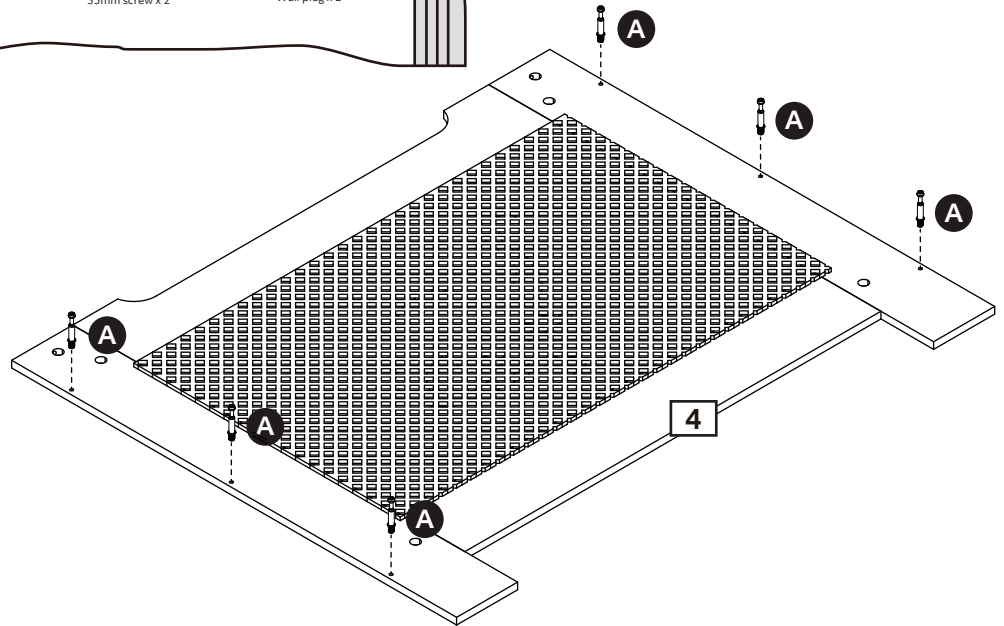
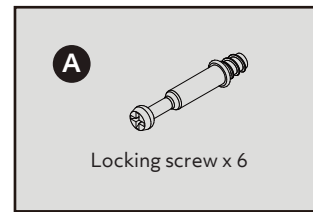
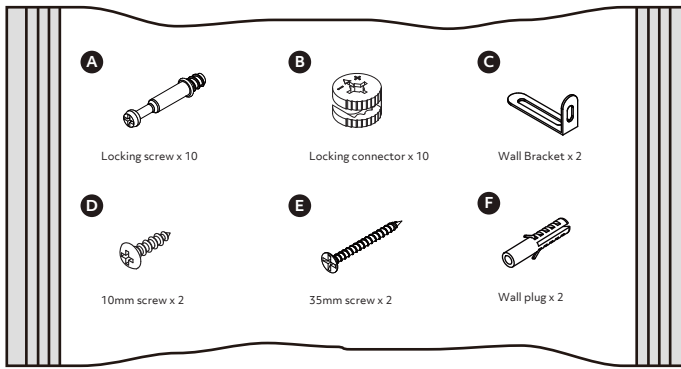

# Step 2

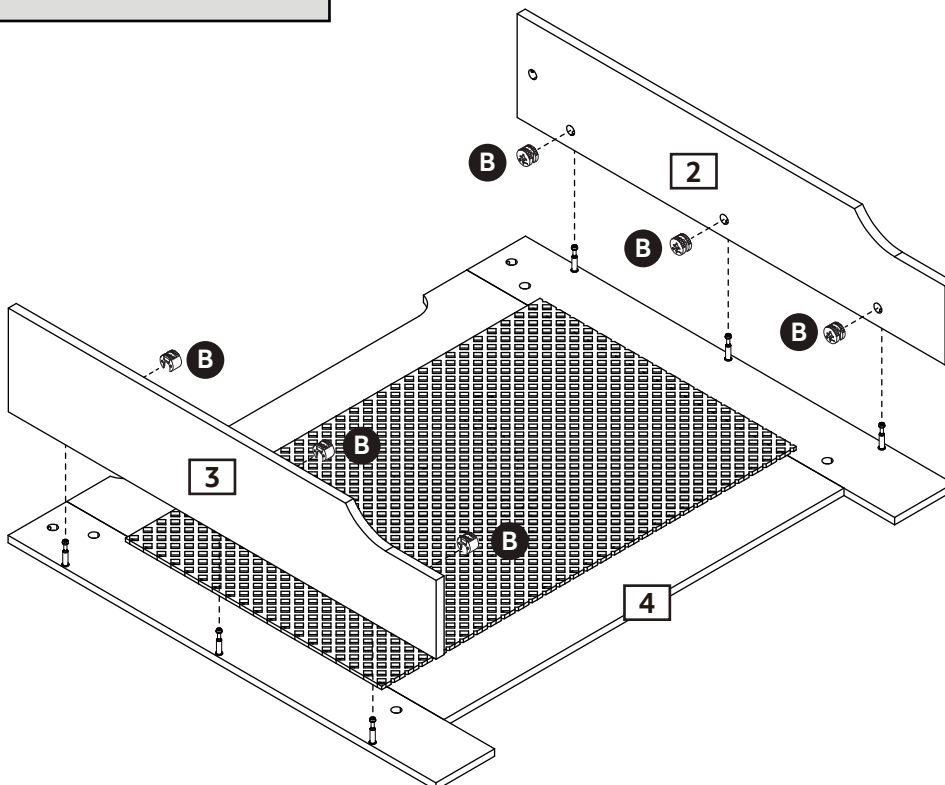
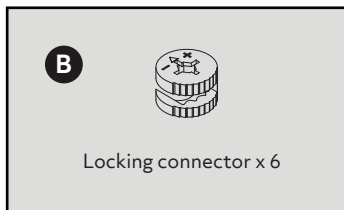

# Step 3

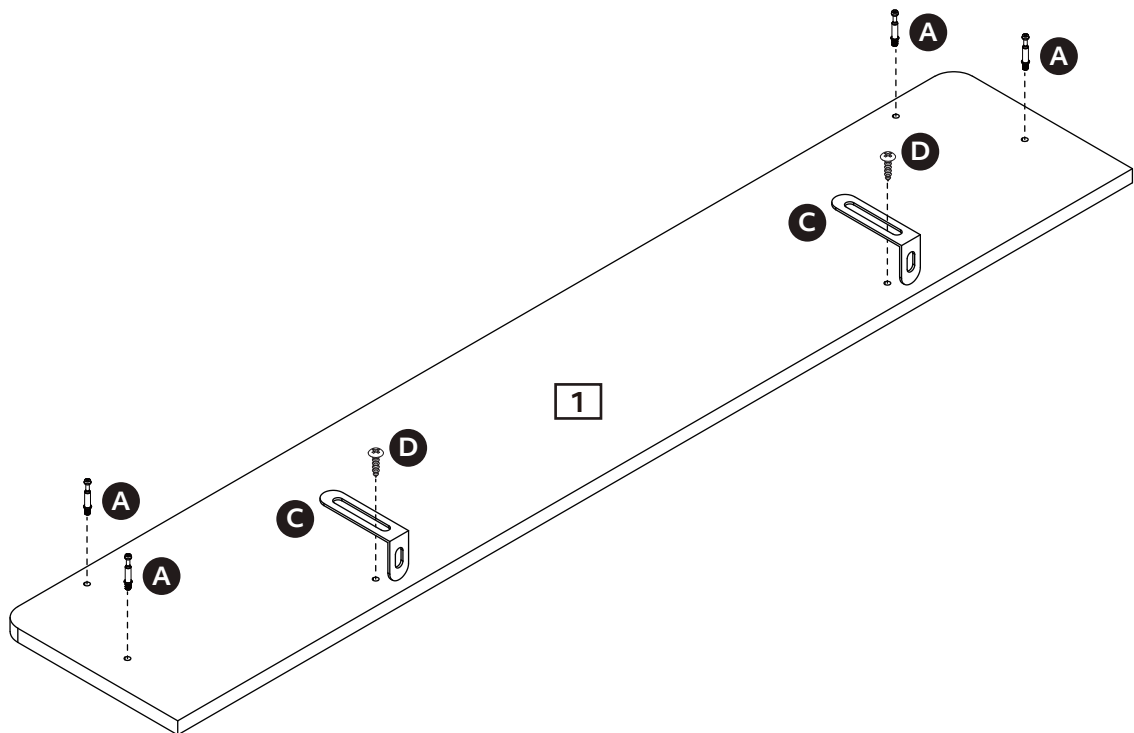
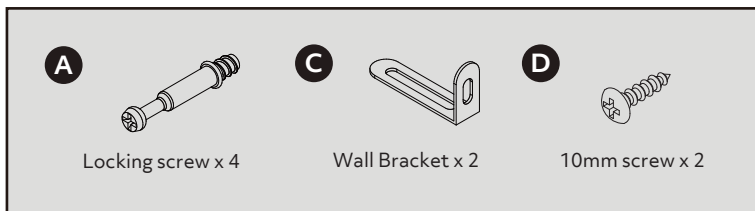

# Step 4

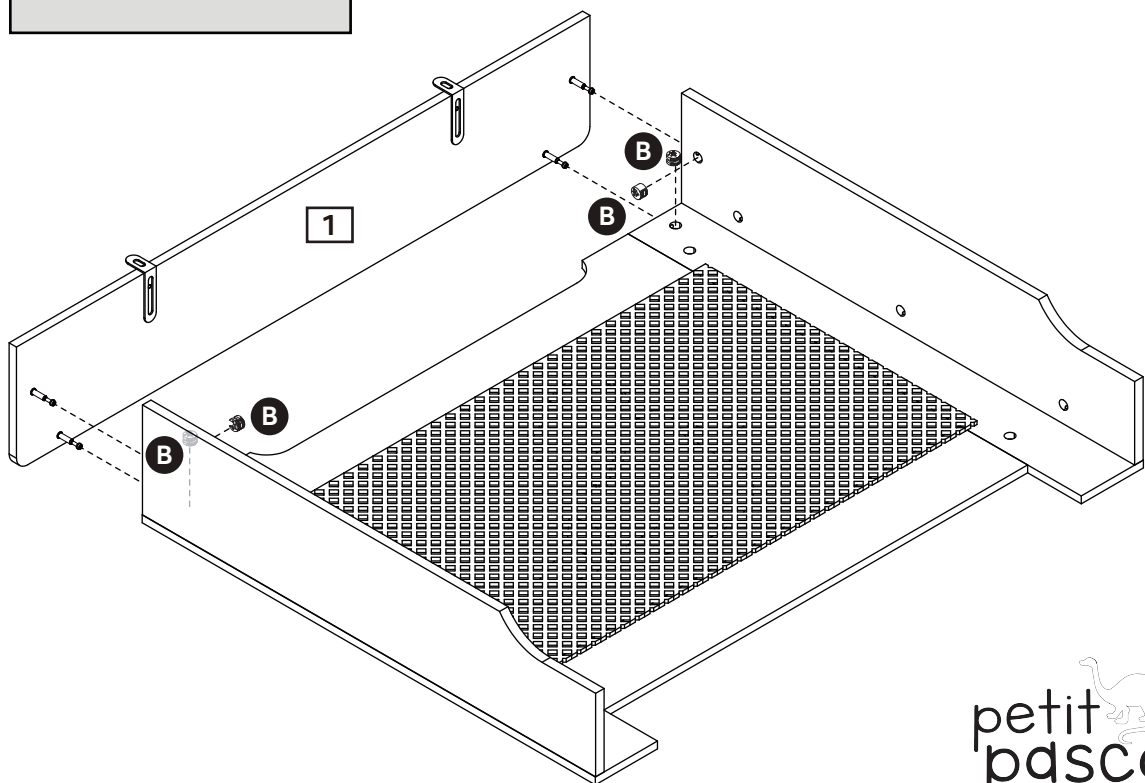
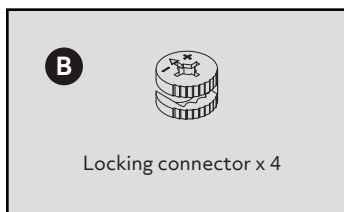

# Step 5

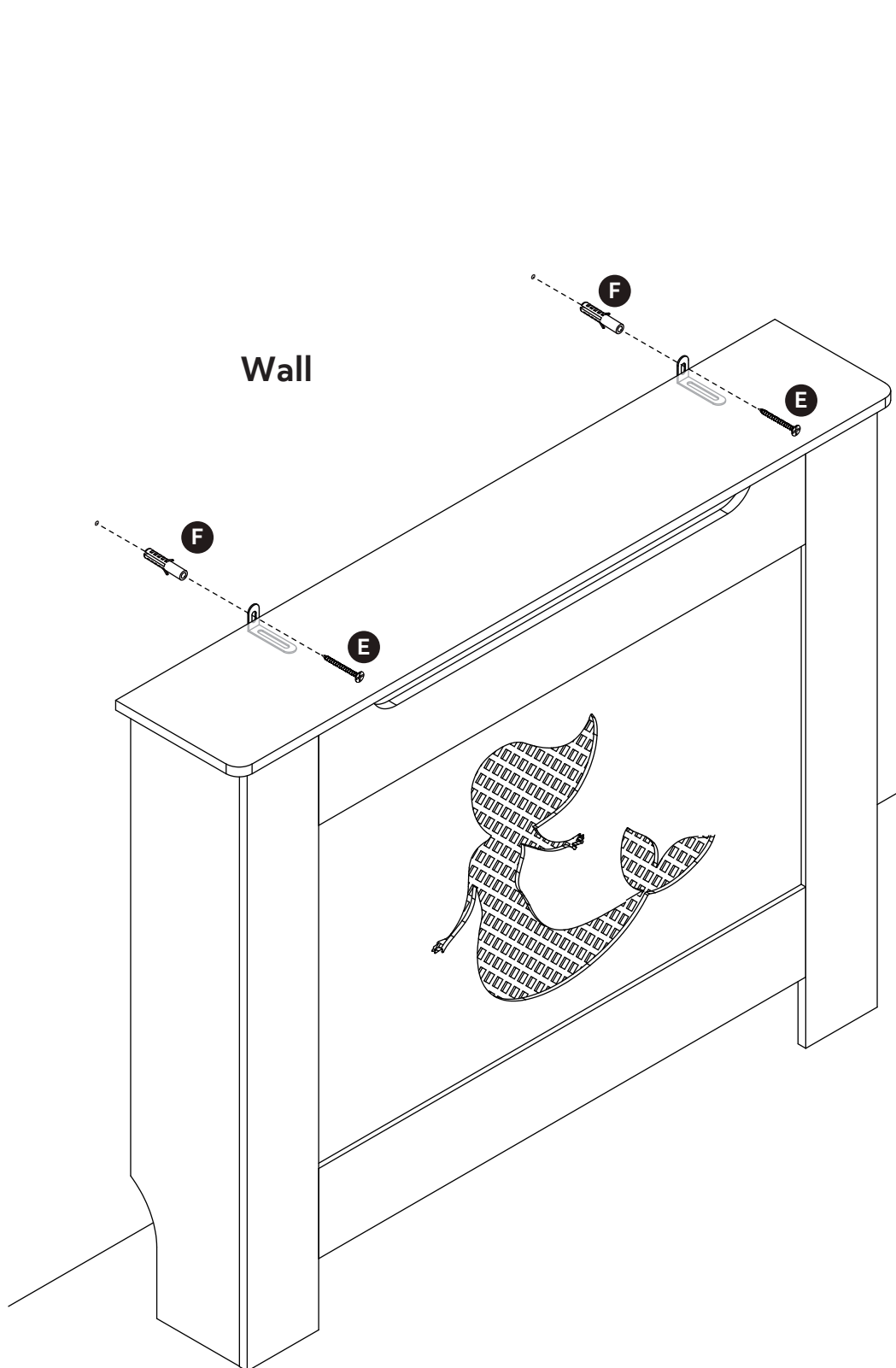
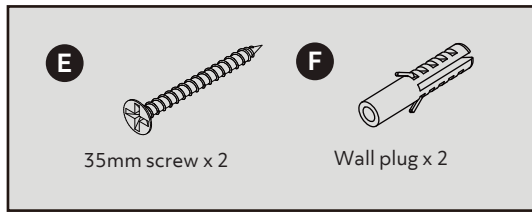



# A Guide to Wall Mounting & Fixings

## Important note:

If plastic wall plugs (rawl plugs) are supplied with your product, eg:



- these are suitable for use in masonry walls

If you are in any doubt about the correct wall plugs for your wall, seek professional advice.

Failure of the product due to using the incorrect fixings is the responsibility of the installer.



**Important:** when drilling into walls always check that there are no hidden wires or pipes etc.



Hints:

1. General rule: always use a larger screw and wall plug if you are not sure.
2. Ensure you use the recommended drill bit to match the wall plug and hole size.
3. Ensure you drill the hole horizontally; do not force the drill or enlarge the hole.
4. Take extra care when drilling high walls, ceilings and ceramic tiles. Ensure wall plugs are inserted beyond the thickness of the ceramic tiles to avoid the tiles splitting or cracking.
5. Ensure wall plugs are well fitted and are a tight fit in the drilled hole.

## Types of walls

You can use one of the following types of wall plug if your walls are made of brick, breeze block, concrete, stone or wood.

No. 1 "General Purpose" wall plug

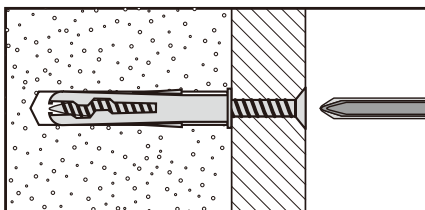

Generally aerated blocks should not be used to support heavy loads, use a specialist fitting in this case. For light loads, general purpose wall plugs can be used.

No. 3 "Cavity Fixing" wall plug

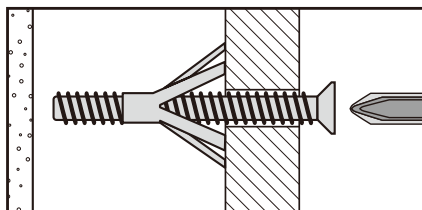

For use with plasterboard partitions or hollow wooden doors.

No. 5 "Hammer Fixing" wall plug

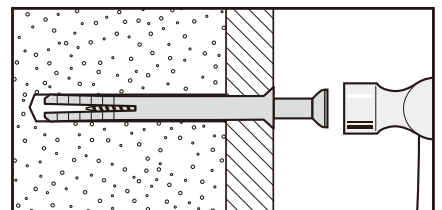

For use with walls stuck with plasterboard. The hammer fixing allows it to be fixed to the wall rather than the plasterboard. Always check the fixing is secure to the retaining wall.

No. 2 "Plasterboard" wall plug

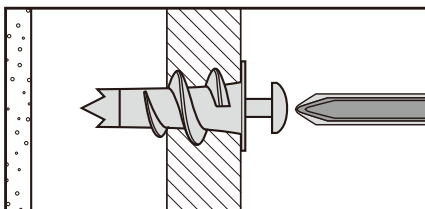

For use when attaching light loads onto plasterboard partitions.

No. 4 "Cavity Fixing - Heavy Duty" wall plug

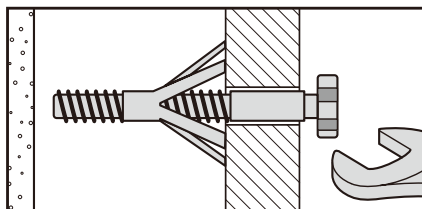

For use when fitting or supporting heavy loads such as shelving, wall cabinets and coat racks.

No. 6 "Shield Anchor" wall plug - heavy loads

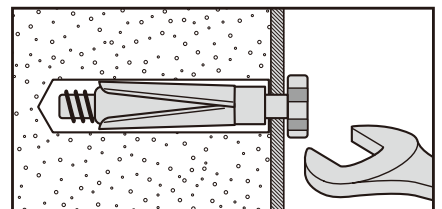

For use with heavier loads such as TV and HiFi speakers and satellite dishes etc.



## Care & Maintenance

**Safety:** Always check the fitting and location to ensure your safety in and around the home.

**Fitting:** From time to time check the fitting to ensure the wall plugs or screws do not become loose.

# Using camlocks

## Step 1

Connect the male camlock as directed in the assembly instructions using a screwdriver.

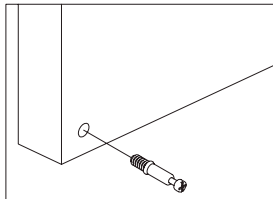

## Step 2

Insert the female camlock as shown in the instructions.

Note: Ensure that the arrow on the top of the camlock points towards the entry hole for the male camlock.

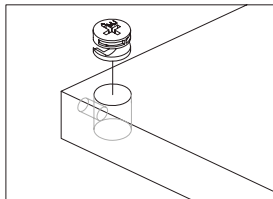

## Step 3

Push the male camlock into every hole.

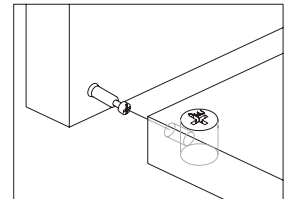

## Step 4

Turn the female camlock with a screwdriver.

You should feel a click when the camlock is locked in place.

The joint is now secure.

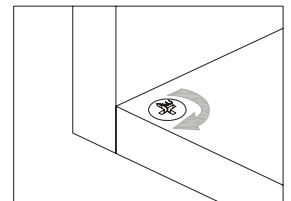

# petit pascal



We would love to see your new product in its new home. **Share your experience** by taking a picture of your Petit Pascal product and **post it on social media** tagging **@petitpascaluk @lloydpascal #welovehome #LPfurniture #LPHome**

**Connect with us:** Using your mobile camera, scan the QR code below and visit our website [www.petitpascal.co.uk](http://www.petitpascal.co.uk)



**@petitpascaluk**