

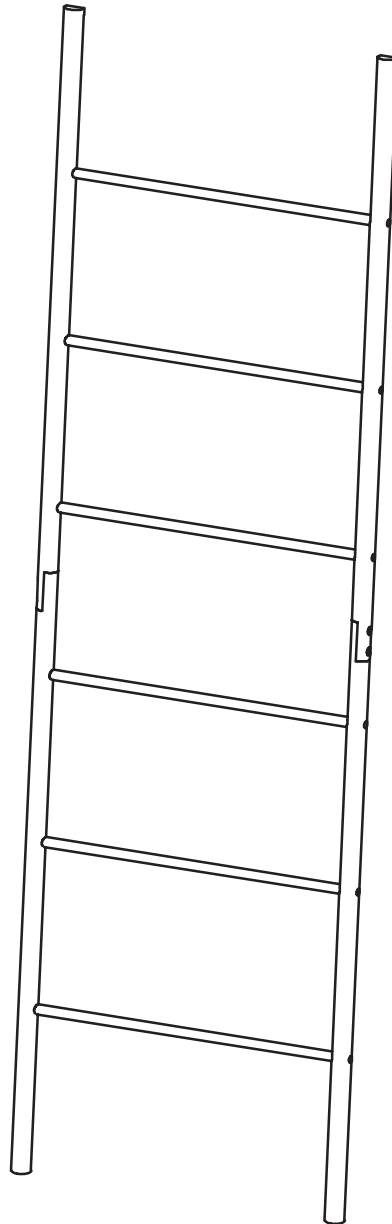

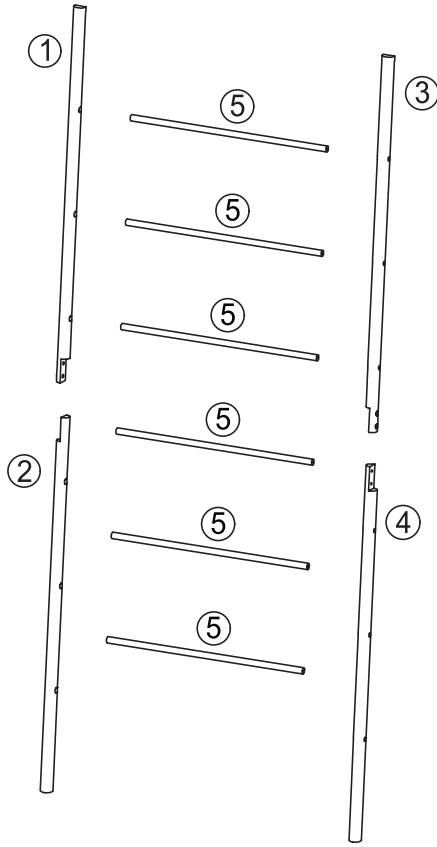



**BAMBOO STORAGE LADDER
ASSEMBLY INSTRUCTIONS**



ELEMENTS

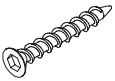
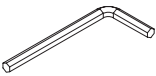

HARDWARE

<p>A</p>  <p>x4</p>	<p>B</p>  <p>x12</p>	<p>C</p>  <p>x1</p>	<p>D</p>  <p>x2</p>
<p>E</p>  <p>x2</p>	<p>F</p>  <p>x2</p>	<p>G</p>  <p>x2</p>	

STEP 1

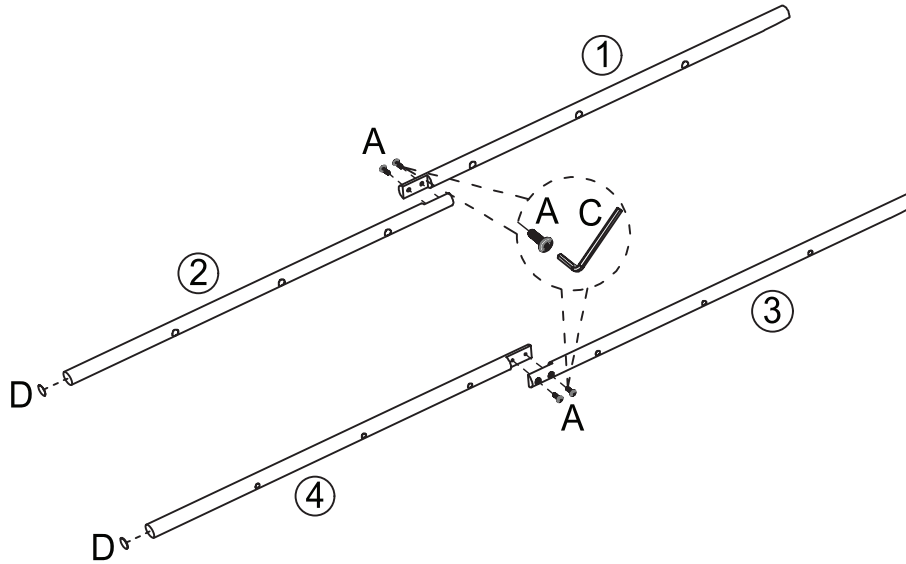

STEP 2

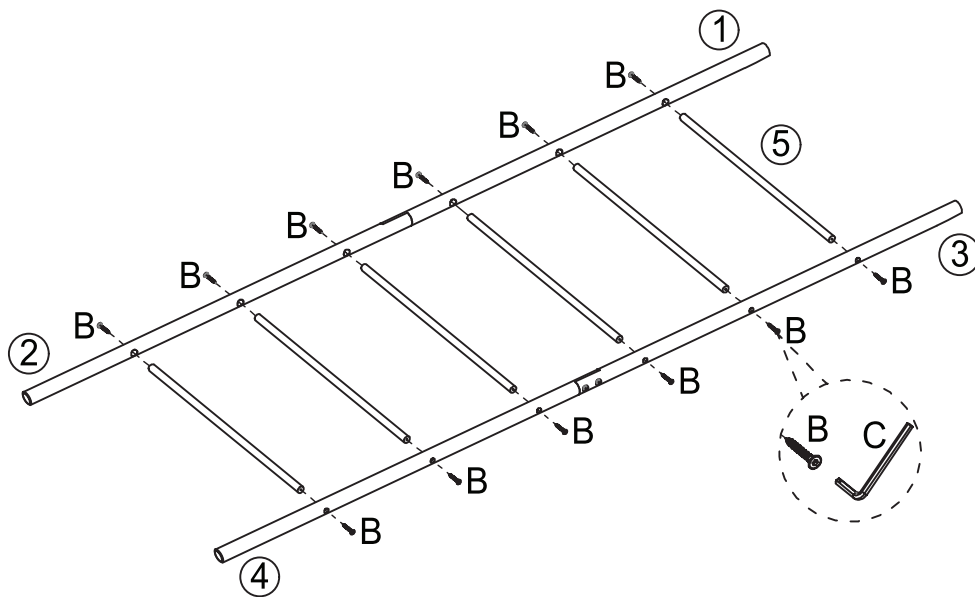

**BAMBOO STORAGE LADDER
ASSEMBLY INSTRUCTIONS**

STEP 3

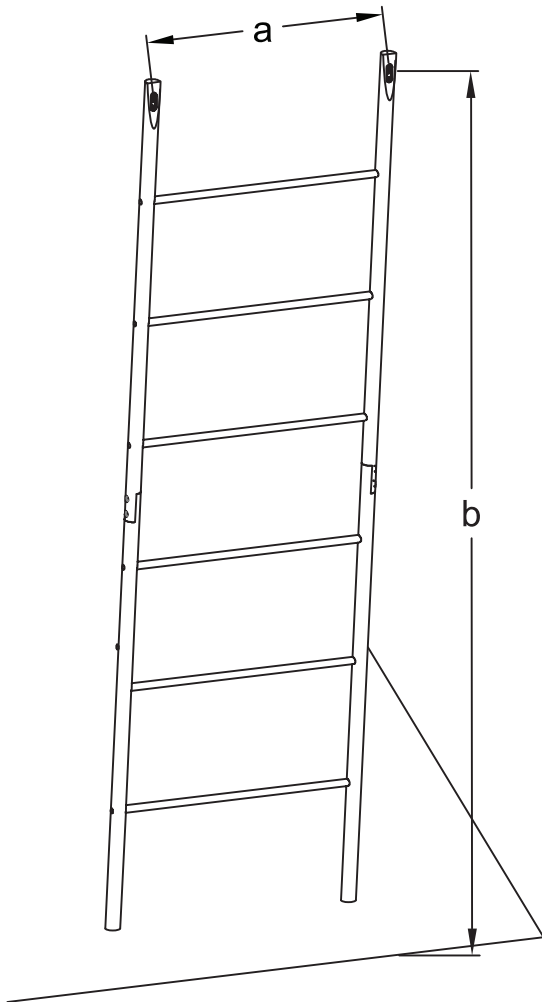

⚠ Please measure actual distance between holes for wall mounting.

STEP 4

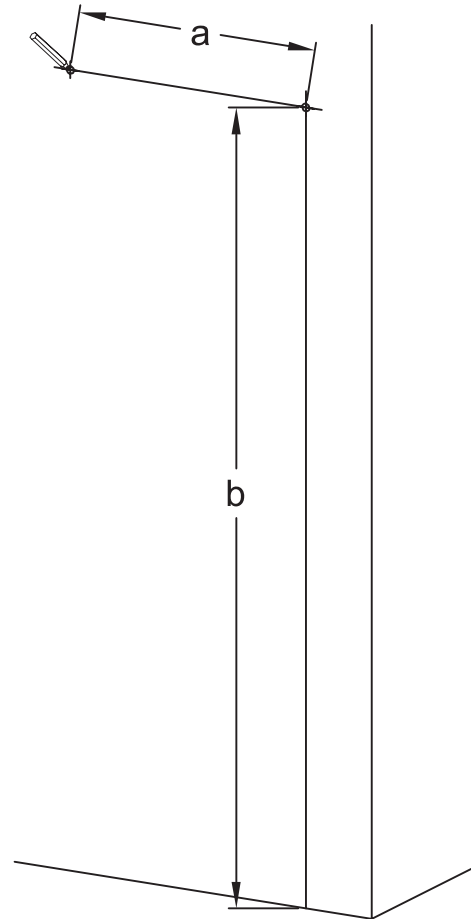

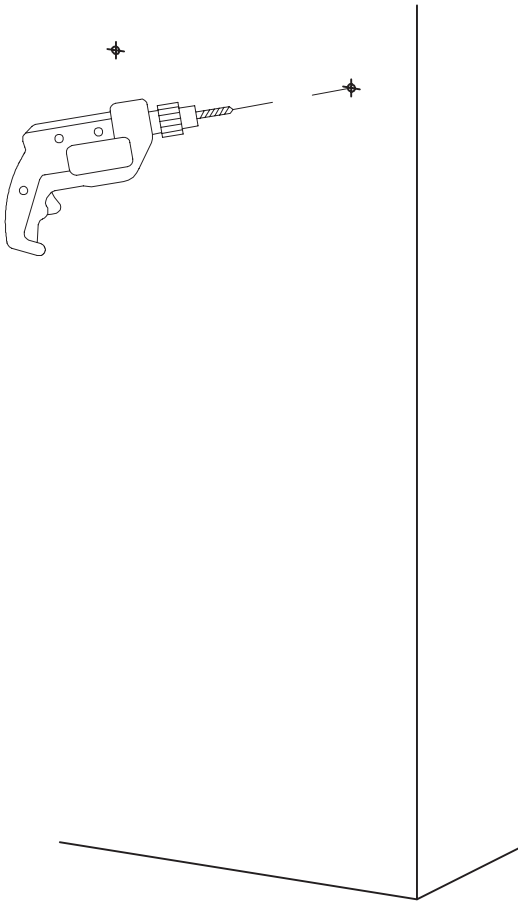

⚠ Please perforate holes on the wall based on actual distance between holes for wall mounting.

STEP 5

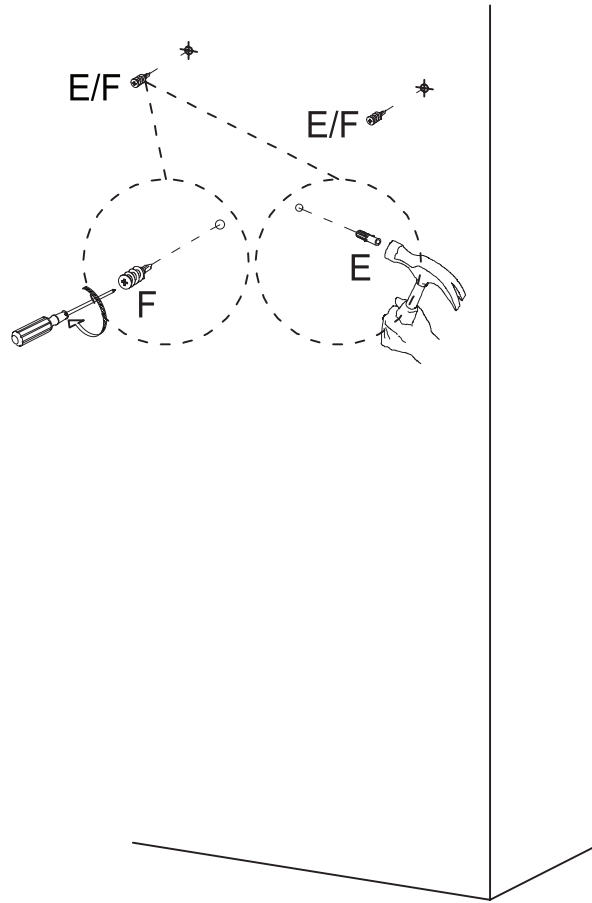

STEP 6



 Please perforate holes on the wall based on actual distance between holes for wall mounting.

STEP 7

