



HOMEBASE

PEARL CEILING LIGHT

INSTRUCTION MANUAL

IMPORTANT: Please read these instructions before using the product and retain for future use.

HHGL Limited, MK9 1BA
HHGL (ROI) Limited, D02 X576

SAFETY AND CARE ADVICE

- For your safety, this product must be installed in accordance with local building regulations. If in any doubt, or where required by law, consult a competent person who is registered with an electrical self-certification scheme. Further information is available online or from your local authority.
- This product has been designed for non-professional, domestic use only.
- Dispose of all packaging correctly and responsibly and in accordance with all local laws and regulations. Never leave packaging components within reach of children, as they can be a source of danger.
- Before inserting or replacing a bulb, ensure the power is switched off and the bulb has cooled down.
- Do not modify or alter any product before or after installation. This may render the product unsafe.
- This is a Class 1 product and does requires an earth connection.
- This fitting must be permanently wired to the electric system.
- Always shut off the power to the circuit before starting installation.

WARNINGS

- This product is not intended for use by persons (including children) with reduced physical, sensory and mental capabilities, or lack of experience and knowledge, unless they have been given supervision or instruction concerning the use of the product by persons responsible for their safety.
- Children should be supervised to ensure that they do not play with the product.
- Do not place this fitting in a damp atmosphere.







CARE AND MAINTENANCE

- Always disconnect the power supply when servicing or cleaning.
- Use a clean, soft, dry or slightly damp cloth for cleaning this product.
- Do not use abrasive cloths or polishes, as this may cause damage to the product.

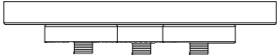
CHANGING BULBS

- This product requires 3 x G9 capsule LED 4W max. 
- This fitting is suitable for dimming when connected to a external dimming switch and using suitable LED dimmable bulbs.
- Ensure that the power supply has been disconnected and the bulb has cooled down before replacing.

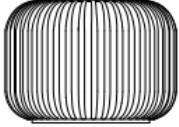
PARTS LIST

 <p>Pre-wired fitting x 1</p>	 <p>Shade ring x 3</p>	 <p>Connector block x 1 (Pre-fitted on the ceiling plate)</p>	 <p>Fixing plugs x 2</p>
 <p>Glass shade x 3</p>	 <p>Fixing bracket x 1 (Pre-fitted on the ceiling plate)</p>	 <p>Fixing screws x 2</p>	

ASSEMBLY

Step 1

1. Remove the fixing bracket from the ceiling plate.
2. Using the fixing bracket as a template, drill suitable holes into a ceiling (taking care not to damage any internal wiring or pipes). Fit the suitable fixing plugs into the holes previously drilled.
3. Attach the fixing bracket to the ceiling using the fixing screws provided.

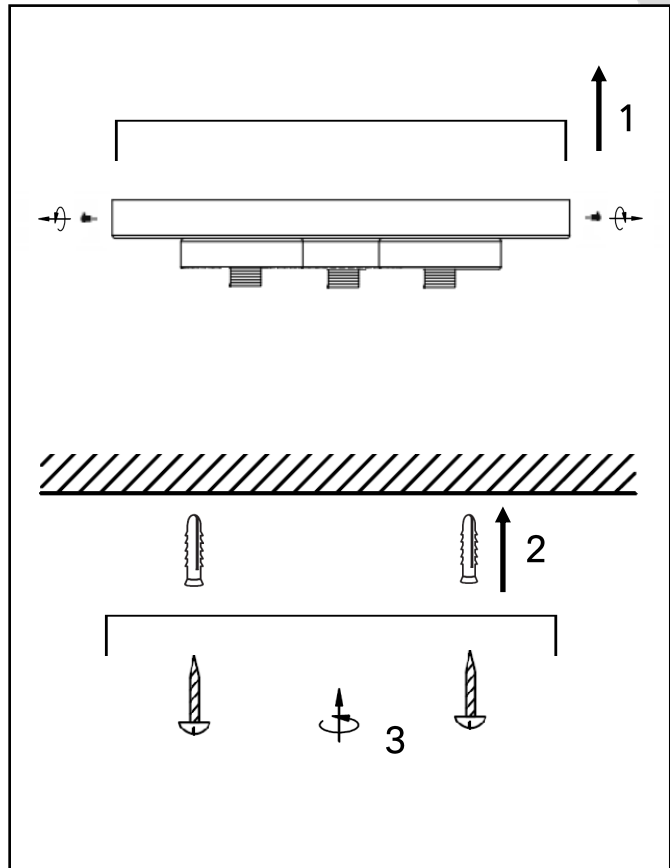

Step 2

1. Connect the supply wires to the terminal block, opposite the corresponding wires from the fitting, see Fig. A. Note: Ensure that the connections are tight and no loose strands of wire are left out of the connector block.
2. Place the fitting over the pre-fixed bracket and secure in place using the side screws.

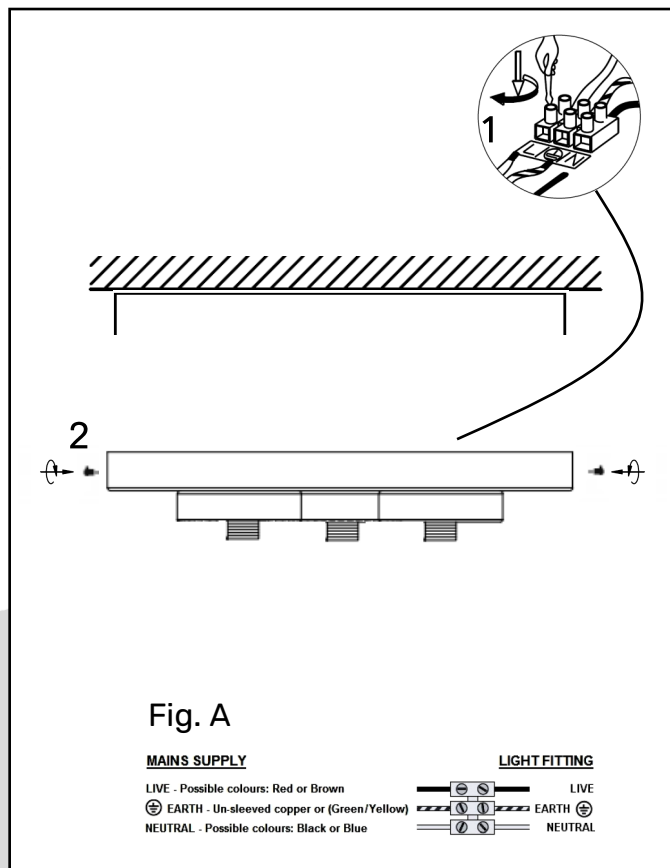

Step 3

1. Un-screw the shade ring from the lamp holder.
2. Place the shade over the lamp holder.
3. Re-screw the shade ring onto the lamp holder to secure the shade in place.

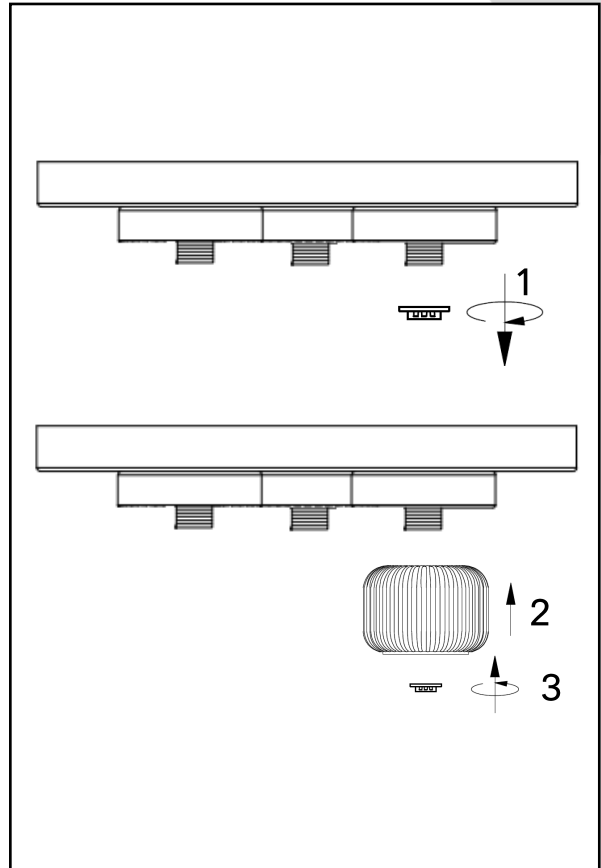

Step 4

Insert the bulbs (not supplied) into the lamp holders, making sure you don't exceed the bulb wattage stated on the product.

