

Hi there,

lloyd Est. 1919
pascal
we love home

Meet your new
Lloyd Pascal
**Country Style
Large Radiator
Cabinet**

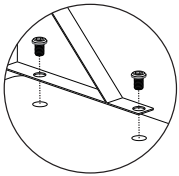

Animated
Overview Video
Instructions

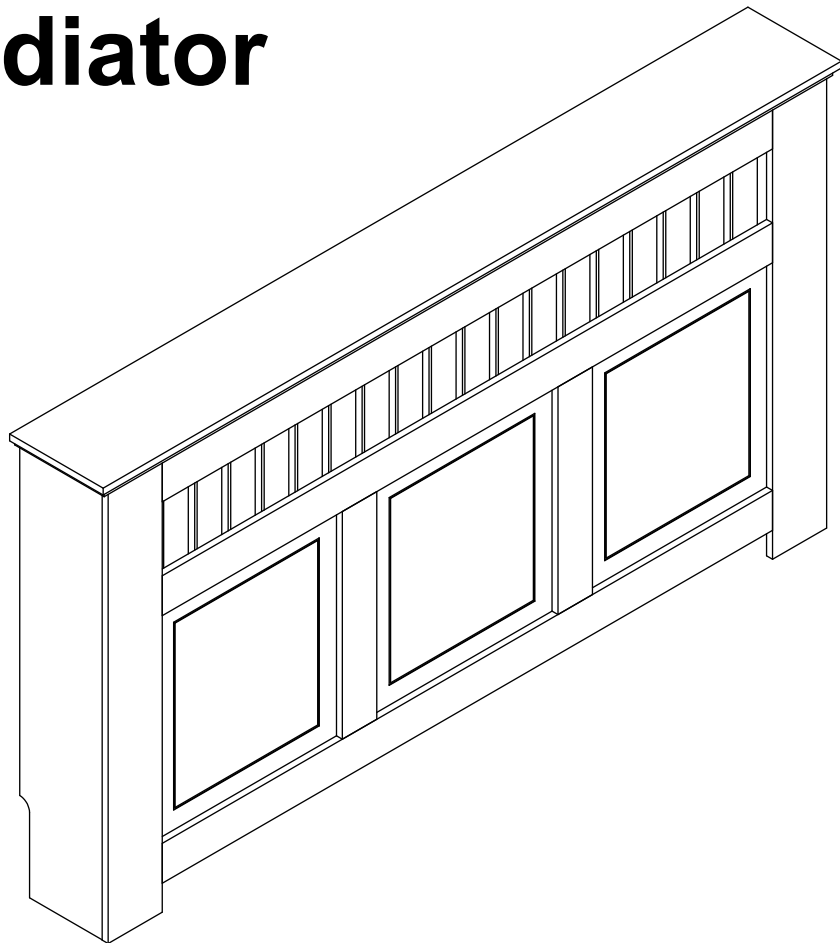

Customer Helpline

If you need help or have damaged or missing parts, call our customer helpline 0121 776 5720 or visit our website at www.lloydpascal.com

Assembly instructions- Please keep for future reference

200.96FSC.154H

Issue 1 - 09/09/21

#welovehome

lloyd pascal

Est.
1919

we love home

Welcome to the Lloyd Pascal family established in 1919

We would love to see your new product in its new home. **Share your experience** by taking a photo or video of your new LP product and **post it on social media tagging** #welovehome #Lloydpascal #LPfurniture #LPHome

Connect with us: Using your mobile camera, scan the QR bar code below of your favourite social media channel and follow us!



Are you loving/satisfied with your new purchase?

Yes: That's perfect. **It would make our day** if you could leave us a **review on our social media channels**. Your feedback will help us develop even better products to love.

No: If for any reason your enjoyment of our product is on hold then **let the retailer** that you purchased your item from know **or contact us** and we will resolve your issue as quickly as possible.

To view our full terms and conditions please visit our website

www.lloydpascal.com

#welovehome

Safety and Care Advice

IMPORTANT, RETAIN FOR FUTURE REFERENCE: READ CAREFULLY.

- Keep children and animals away from the work area, small parts could choke if swallowed.
- Make sure you have enough space to layout the parts before starting.
- This product has been constructed to be used in the domestic environment only and not for commercial purposes.

Care and maintenance

- Only clean using a damp cloth and mild detergent. Do not use abrasive cleaners.

- Assemble the item as close to its final position (in the same room) as possible.
- Assemble on a soft level surface to avoid damaging the unit or your floor.
- The surface should be protected from liquids, heat or cold by using a coaster or mat. The surface is not water resistant and may be damaged or discoloured if not protected.



- We do not recommend the use of power drill/drivers for inserting screws as this could damage the unit. Only use

hand screwdrivers.

- Parts of the assembly will be easier with 2 people.
- Dispose of all packaging carefully and responsibly.

- From time to time check that there are no loose screws, nuts or bolts. If there are please re-tighten.

- This product should not be discarded with household waste. Take to your local authority waste disposal centre.

Additional Guidance

- Assemble all parts and bolts loosely during assembly, only once the product is complete should you fully tighten the bolts.
- Regularly check and ensure that all bolts and fittings are tightened properly.

Fittings

Please check that you have all the fittings listed below:

NOTE: The quantities below are the correct amount to complete the assembly. In some cases more fittings may be supplied than required.

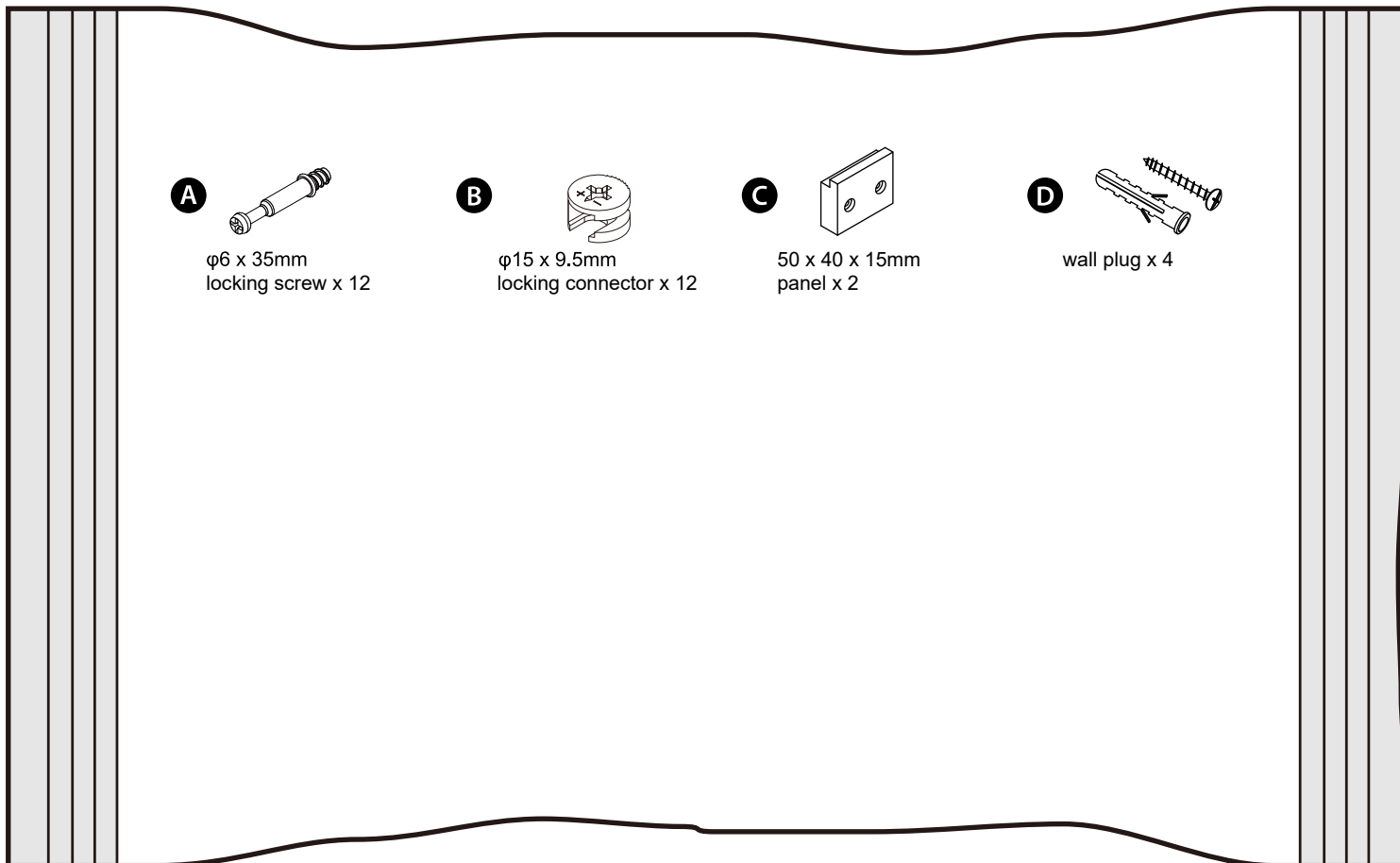

Tools required

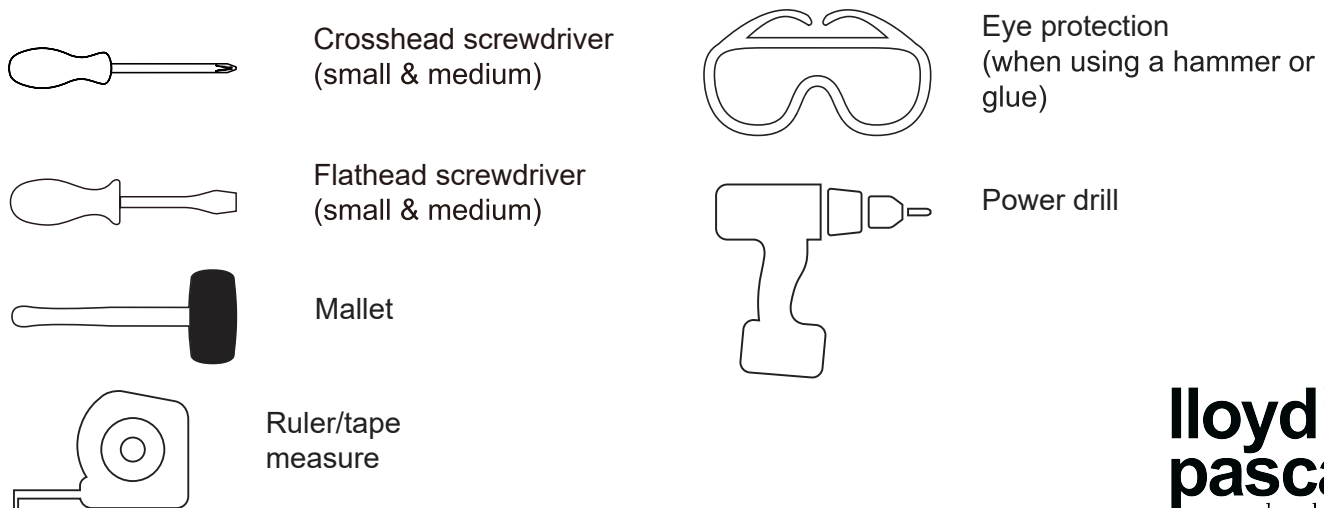

Panels

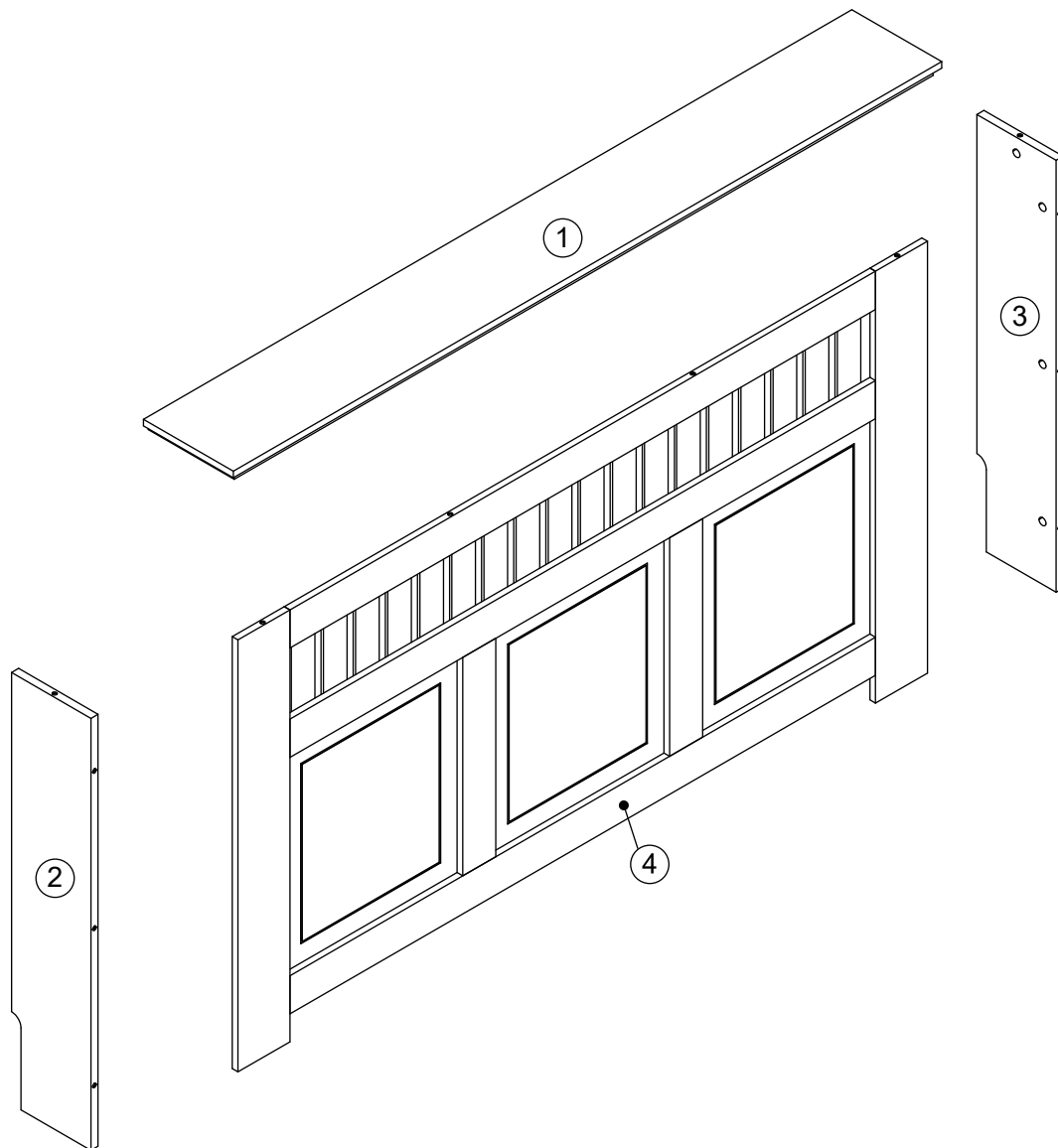

Panel List

1.	Top panel	150 x 19 x 2.4 cm	x 1
2.	Left side panel	79 x 15.7 x 1.5 cm	x 1
3.	Right side panel	79 x 15.7 x 1.5 cm	x 1
4.	Face panel	146 x 79 x 1.2 cm	x 1

1

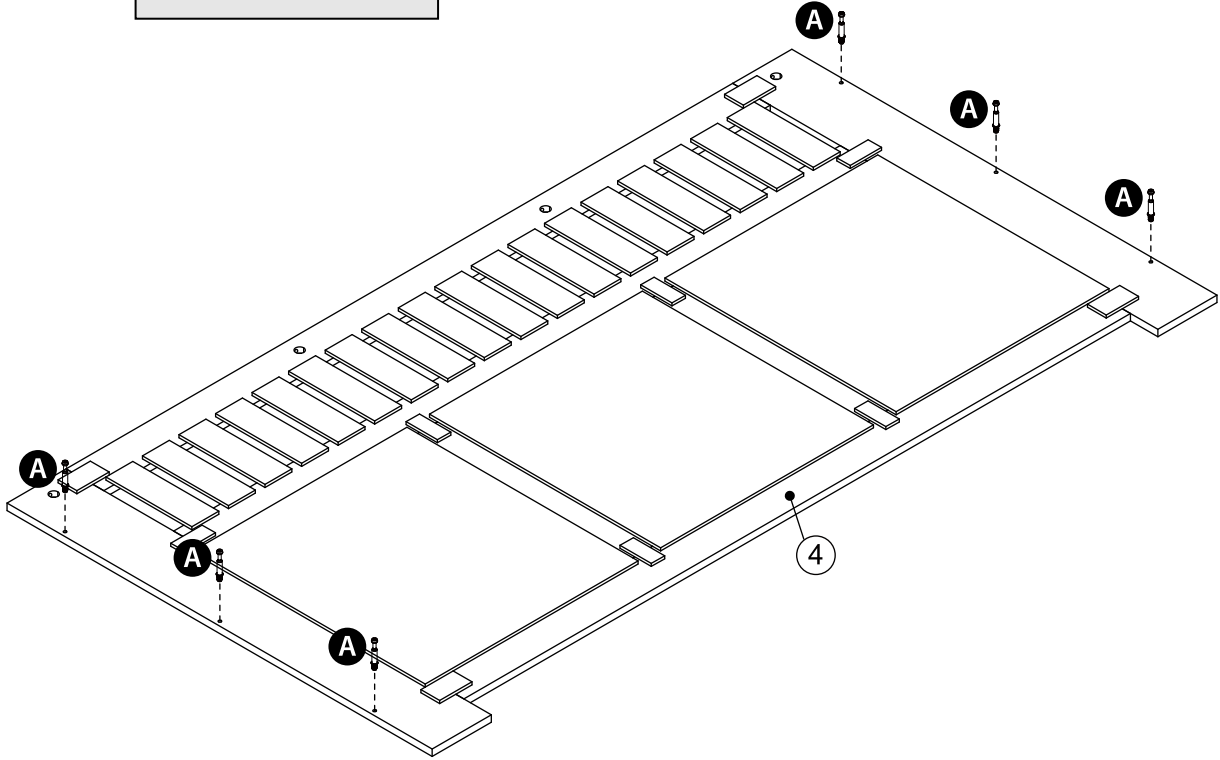
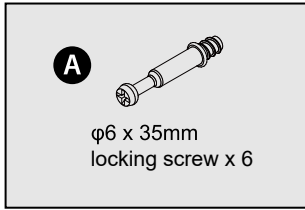

2

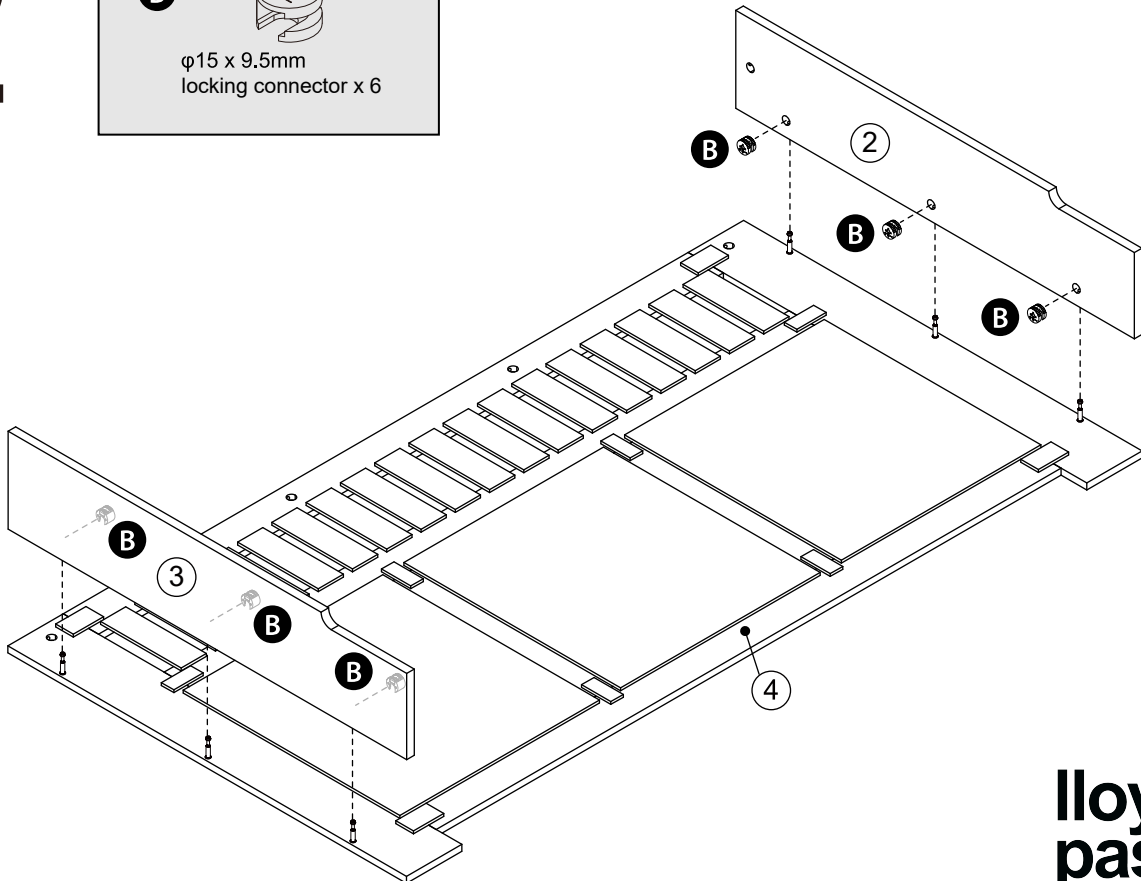
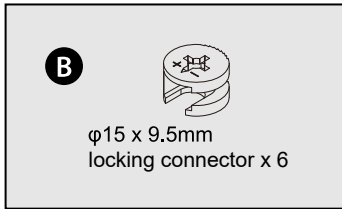

3

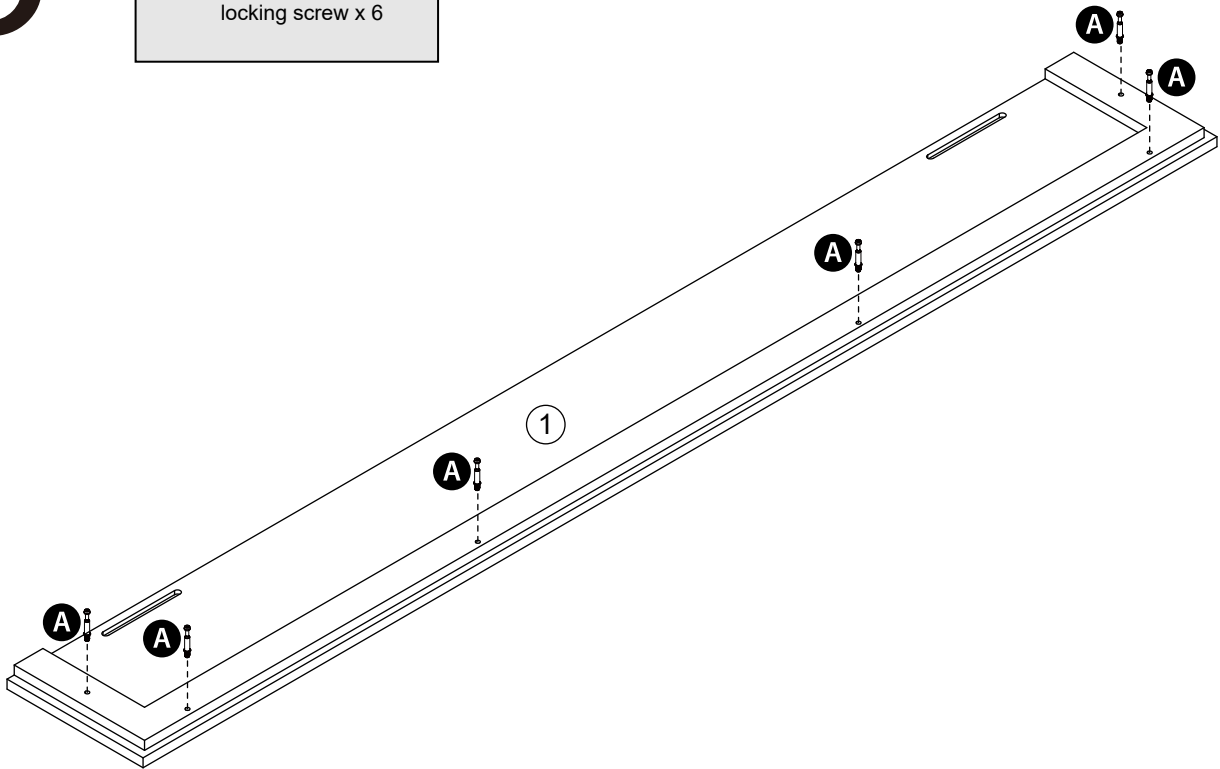
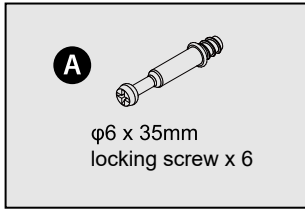

4

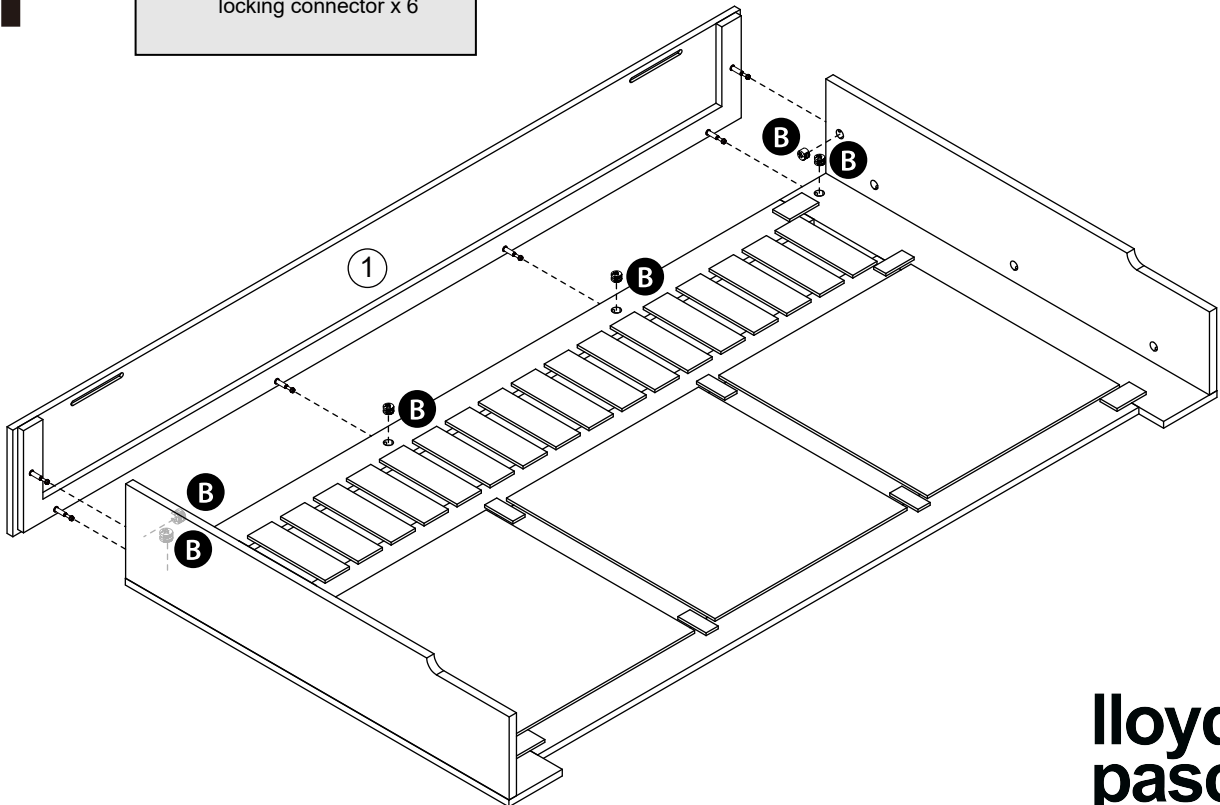
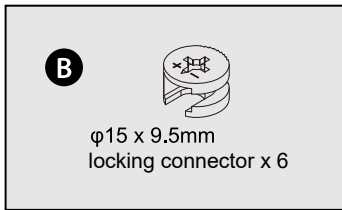

5

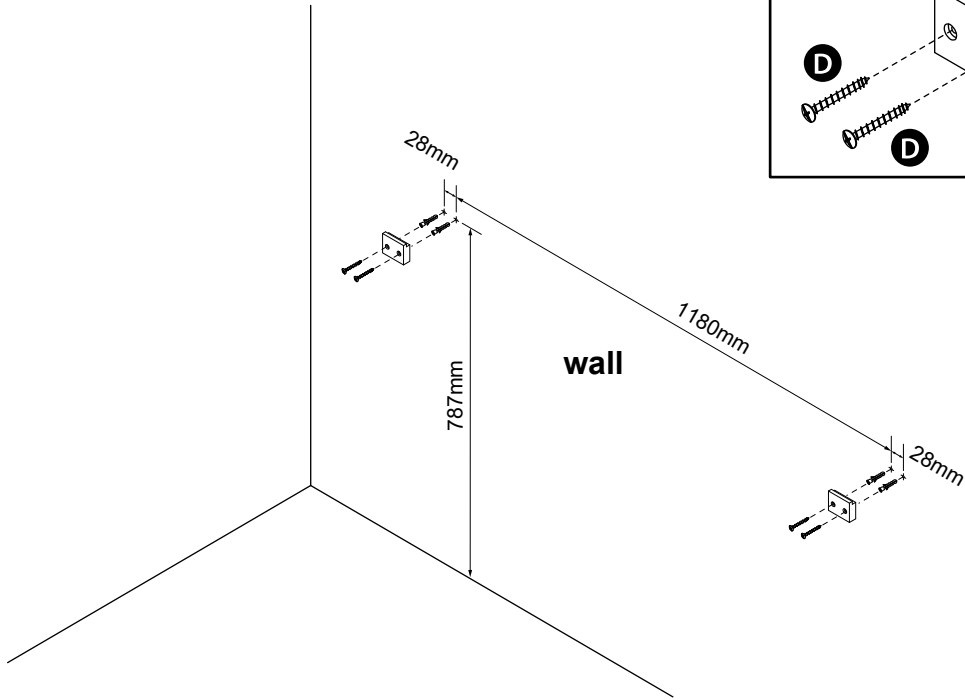
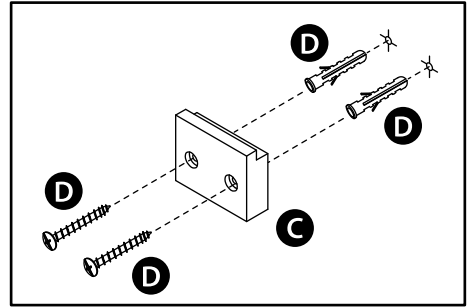
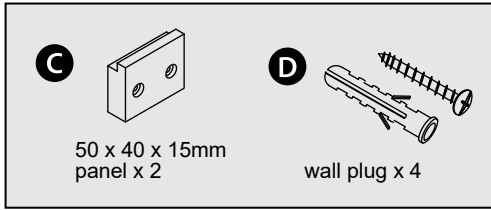

6

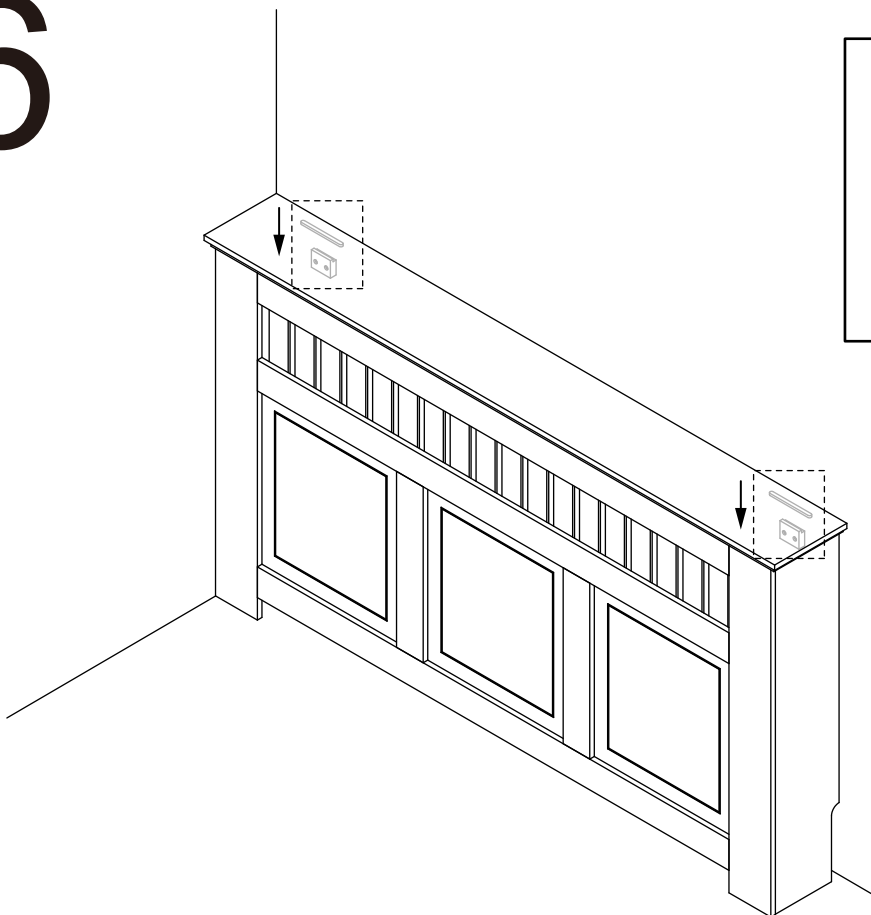
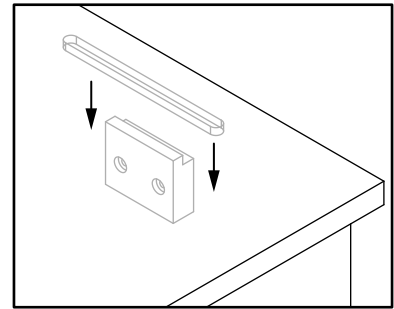

A Guide to Wall Mounting & Fixings

Important note:

If plastic wall plugs (rawl plugs) are supplied with your product, eg:



- these are suitable for use in masonry walls

If you are in any doubt about the correct wall plugs for your wall, seek professional advice.

Failure of the product due to using the incorrect fixings is the responsibility of the installer.



Important: when drilling into walls always check that there are no hidden wires or pipes etc.

Make sure that the screws and wall plugs being used are suitable for supporting your unit. Consult a qualified tradesperson if you are unsure.



Hints:

1. General rule: always use a larger screw and wall plug if you are not sure.
2. Ensure you use the recommended drill bit to match the wall plug and hole size.
3. Ensure you drill the hole horizontally; do not force the drill or enlarge the hole.
4. Take extra care when drilling high walls, ceilings and ceramic tiles. Ensure wall plugs are inserted beyond the thickness of the ceramic tiles to avoid the tiles splitting or cracking.
5. Ensure wall plugs are well fitted and are a tight fit in the drilled hole.

Types of walls

You can use one of the following types of wall plug if your walls are made of brick, breeze block, concrete, stone or wood.

No. 1 "General Purpose" wall plug

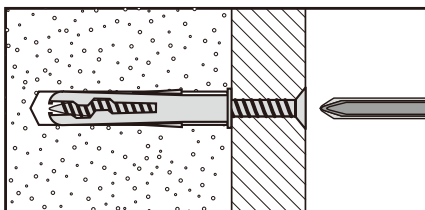

Generally aerated blocks should not be used to support heavy loads, use a specialist fitting in this case. For light loads, general purpose wall plugs can be used.

No. 3 "Cavity Fixing" wall plug

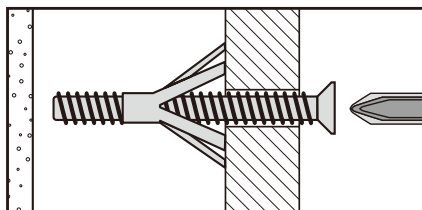

For use with plasterboard partitions or hollow wooden doors.

No. 5 "Hammer Fixing" wall plug

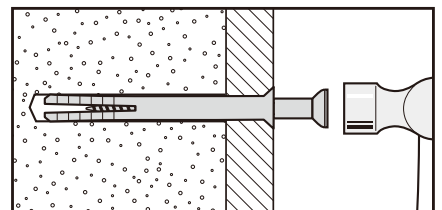

For use with walls stuck with plasterboard. The hammer fixing allows it to be fixed to the wall rather than the plasterboard. Always check the fixing is secure to the retaining wall.

No. 2 "Plasterboard" wall plug

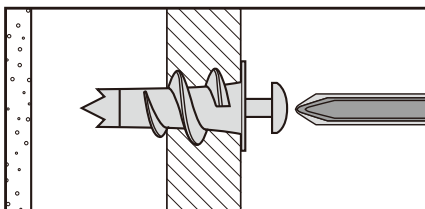

For use when attaching light loads onto plasterboard partitions.

No. 4 "Cavity Fixing - Heavy Duty" wall plug

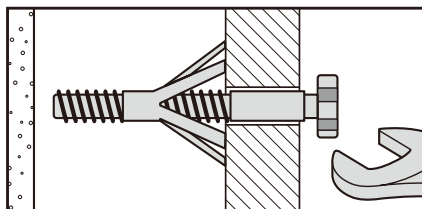

For use when fitting or supporting heavy loads such as shelving, wall cabinets and coat racks.

No. 6 "Shield Anchor" wall plug - heavy loads

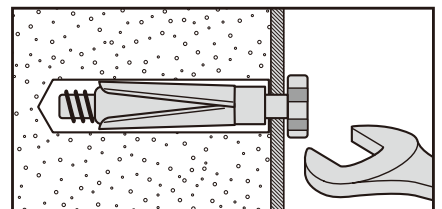

For use with heavier loads such as TV and HiFi speakers and satellite dishes etc.



Care & Maintenance

Safety: Always check the fitting and location to ensure your safety in and around the home.

Fitting: From time to time check the fitting to ensure the wall plugs or screws do not become loose.

Using camlocks

Step 1

Connect the male camlock as directed in the assembly instructions using a screwdriver.

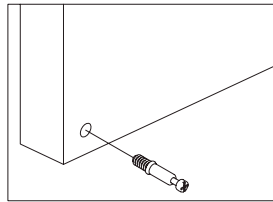

Step 3

Push the male camlock into every hole.

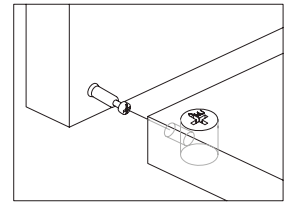

Step 2

Insert the female camlock as shown in the instructions.

Note: Ensure that the arrow on the top of the camlock points towards the entry hole for the male camlock.

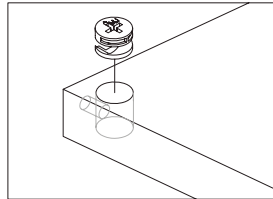

Step 4

Turn the female camlock with a screwdriver. You should feel a click when the camlock is locked in place. The joint is now secure.

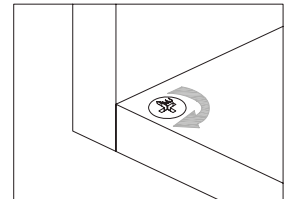

For how to use camlocks watch our video

<https://vimeo.com/340876871>