

HOMEBASE

NORBURY PETITE CABINET

H75 x W70 x D33cm

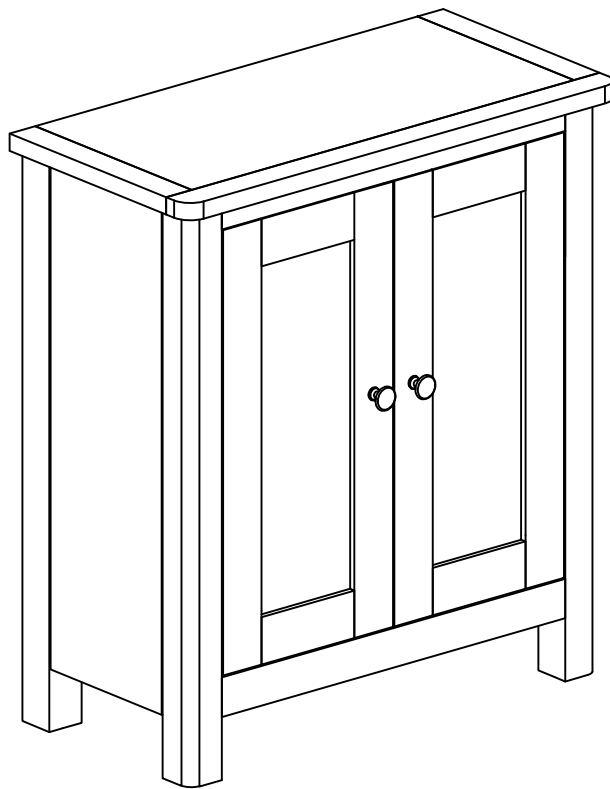

INSTRUCTION MANUAL

IMPORTANT: Please read these instructions before using the product and retain for future use.

HHGL Limited, MK9 1BA; HHGL (ROI) Limited, D02 X576

SAFETY AND CARE ADVICE

- Keep children and animals away from the work area; small parts could pose a choking hazard.
- For ease and speed of assembly, we recommend that you identify all the parts required for each step before you commence assembly.
- This product is designed for domestic use only.
- We recommend that you assemble the product as close to its final position as possible, to avoid moving the product unnecessarily once assembled.
- Assemble on a soft, level surface to avoid damaging the product or your floor.
- We do not recommend the use of a power drill/driver for inserting screws, as this could damage the product. Only use a hand screwdriver.
- Parts of the assembly will be easier with 2 people.
- Assemble all parts and bolts loosely during assembly; tighten bolts fully once the product is assembled.
- Dispose of all packaging carefully and responsibly.



CARE AND MAINTENANCE

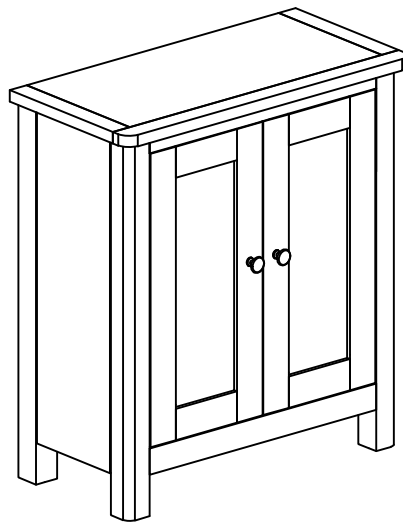

- Only clean using a damp cloth and mild detergent; do not use bleach or abrasive cleaners.
- Furniture polish is not recommended.
- From time to time, check that there are no loose screws, nuts or bolts. If there are, please re-tighten.
- This product should not be discarded with household waste. Take it to your local authority waste disposal centre

PARTS LIST

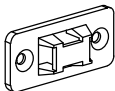

① Petite cabinet x 1

Fixings list

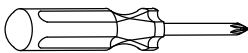
<p>Ⓐ</p>  <p>Brackets x 4</p>	<p>Ⓑ</p>  <p>Ties x 2</p>	<p>Ⓒ</p>  <p>Screws \varnothing4L20 x 4</p>	 <p>Screwdriver (not included)</p>
--	--	---	---

Warning!

To prevent injury and property damage from unexpected tipping of furniture, we highly recommend installation of the anti-tip kit included with this product.

NOTE:

Never allow children to climb or hang on the drawers, doors or shelves.

Place the heaviest items in the lowest drawers or shelves.

Never open more than one drawer at a time.

A suitable attachment device is provided with your product; however, you will need to source suitable fixings for your wall.

If in doubt, please consult a qualified tradesperson or visit your local store.

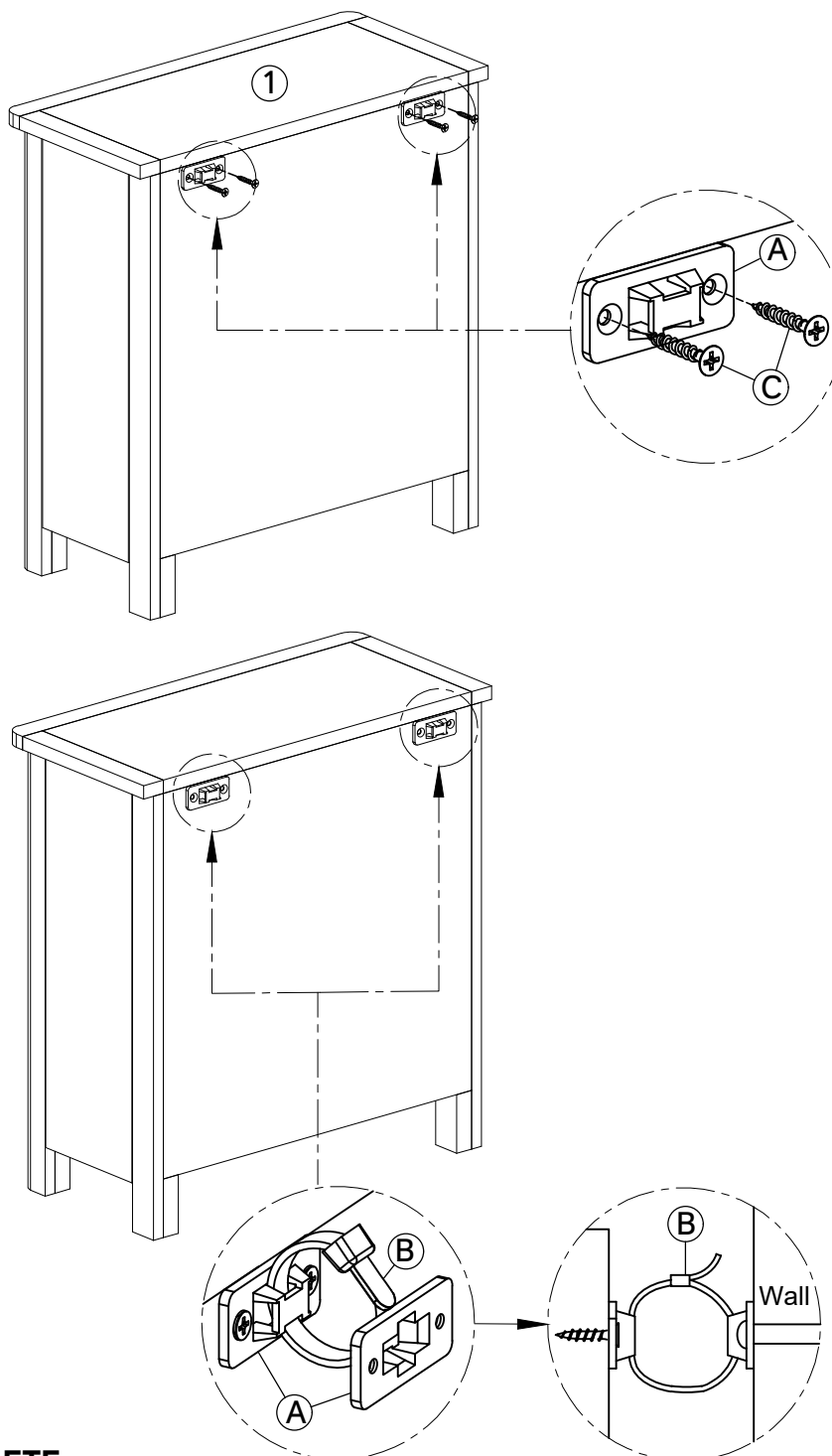

ASSEMBLY COMPLETE

Important note:

If plastic wall plugs are supplied with your product:

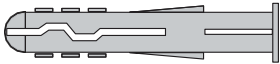

These are only suitable for use in masonry walls.

If you are in any doubt about the correct wall plugs for your wall, seek professional advice.

Failure of the product due to using incorrect fixings is the responsibility of the installer.



Important: When drilling into walls always check that there are no hidden wires or pipes, etc.

Make sure that the screws and wall plugs being used are suitable for supporting your unit. Consult a qualified tradesperson if you are unsure.

Hints:

- 1: **General rule:** Always use a larger screw and wall plug if you are not sure.
- 2: Ensure you use the recommended drill bit to match the wall plug and hole size.
- 3: Ensure you drill the hole horizontally; do not force the drill or enlarge the hole.
- 4: Take extra care when drilling high walls, ceilings and ceramic tiles. Ensure wall plugs are inserted beyond the thickness of the ceramic tiles to avoid the tiles splitting or cracking.
- 5: Ensure wall plugs are well fitted and are a tight fit in the drilled hole.

Types of walls

You can use one of the following types of wall plug if your walls are made of brick, breeze block, concrete, stone or wood.

No. 1 'General Purpose' wall plug

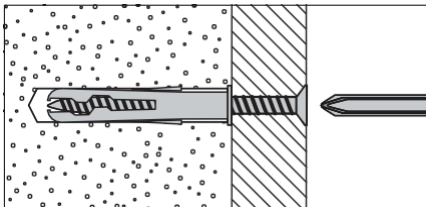

Generally aerated blocks should not be used to support heavy loads, use a specialist fitting in this case. For light loads, general purpose wall plugs can be used.

No. 2 'Plasterboard' wall plug

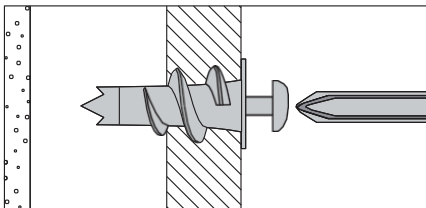

For use when attaching light loads onto plasterboard partitions.

No. 3 'Cavity Fixing' wall plug

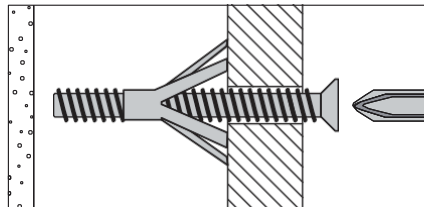

For use with plasterboard partitions or hollow wooden doors.

No. 4 'Cavity Fixing Heavy-Duty' wall plug

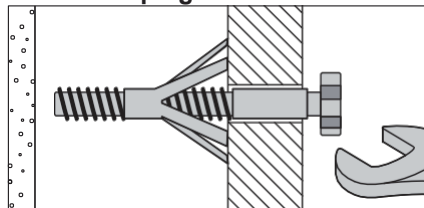

For use when fitting or supporting heavy loads, such as shelving, wall cabinets and coat racks.

No. 5 'Hammer Fixing' wall plug

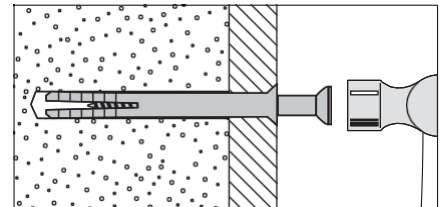

For use with walls stuck with plasterboard. The hammer fixing allows it to be fixed to the wall rather than the plasterboard. Always check the fixing is secure to the retaining wall.

No. 6 'Shield Anchor' wall plug heavy loads

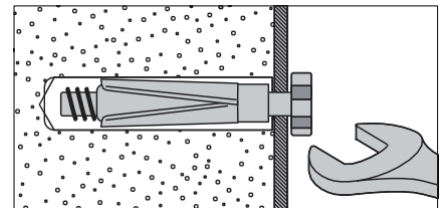

For use with heavier loads, such as TV and HiFi speakers, and satellite dishes.



Care and maintenance

Safety: Always check the fitting and location to ensure your safety in and around the home.

Fitting: From time to time, check the fitting to ensure the wall plugs or screws do not become loose.