

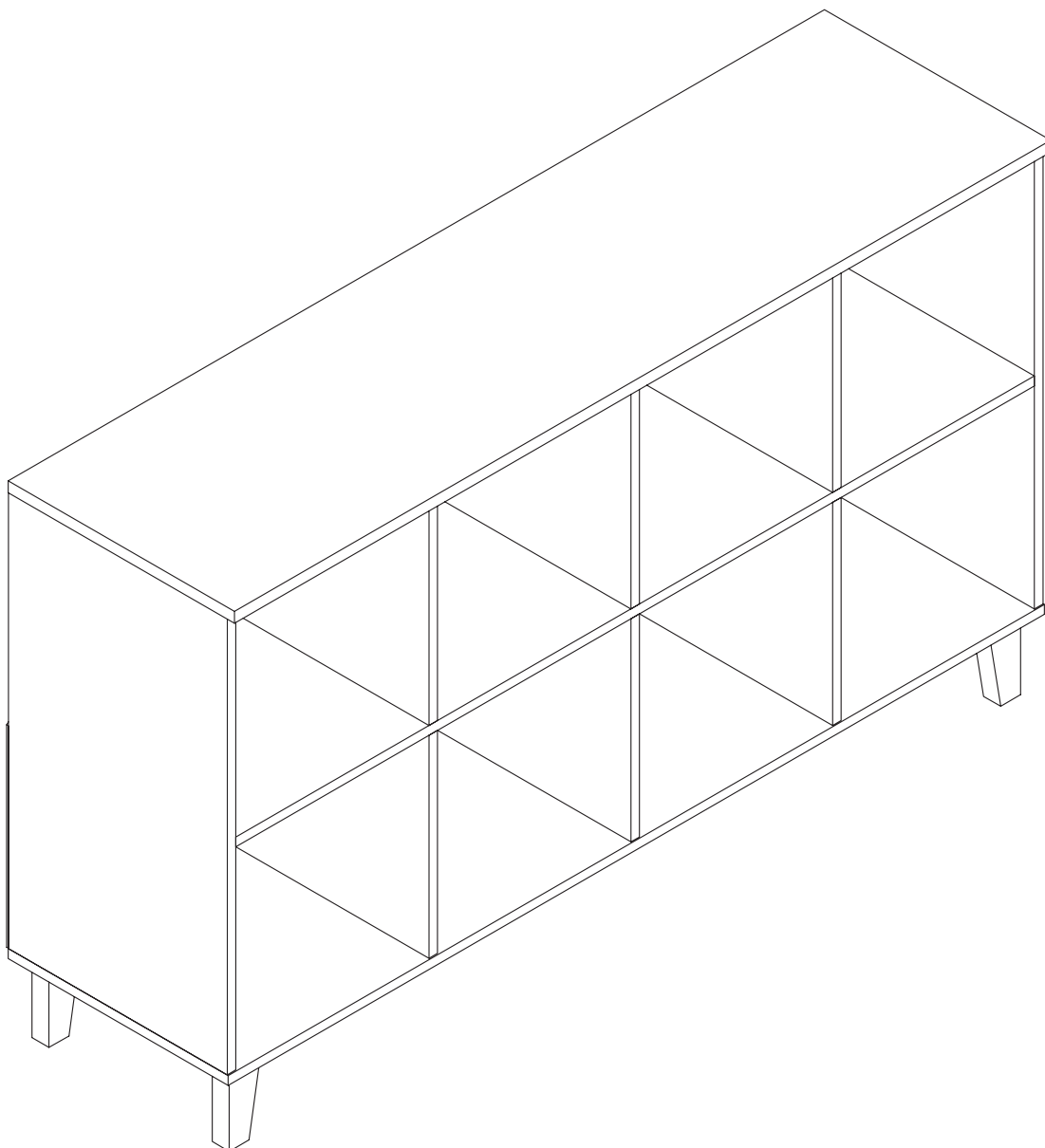









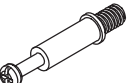

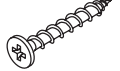
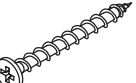

**THIS PRODUCT SHOULD BE ANCHORED TO A WALL OR OTHER SUITABLE SURFACE
TO AVOID SERIOUS INJURY OR DEATH.**

To help avoid any serious injury or death, this product includes a bracket to prevent toppling. We strongly recommend that this product be permanently fixed to the wall or other suitable surface. Fixing hardware is not included since different surface materials require different attachments. Please seek professional advice if you are in doubt as to which fixing hardware to use. Regularly check your fixing device.



HARDWARE

A  x20	B  x20	C  x24	D  x10	E  x16	F  x5	G  x22
H  x32	I  WHITE x16	J  OAK x4	K  x2	L  x2	M  x2	N  x6

ELEMENTS

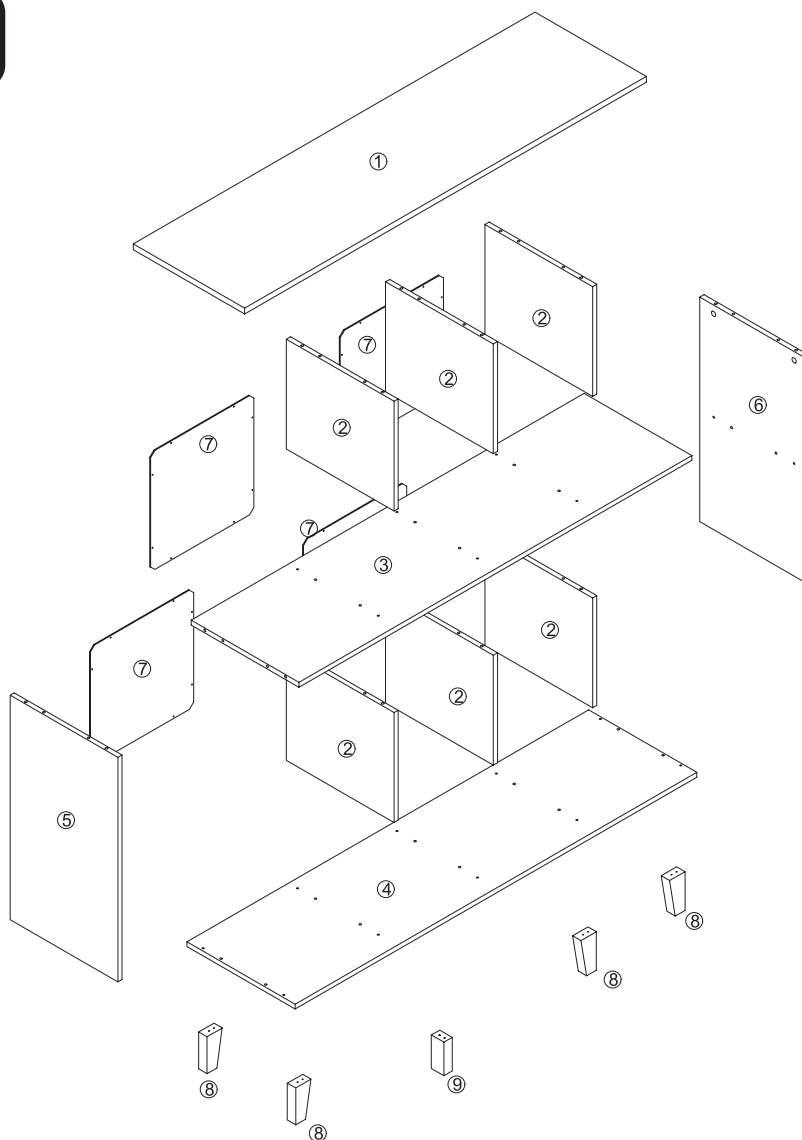

STEP 1

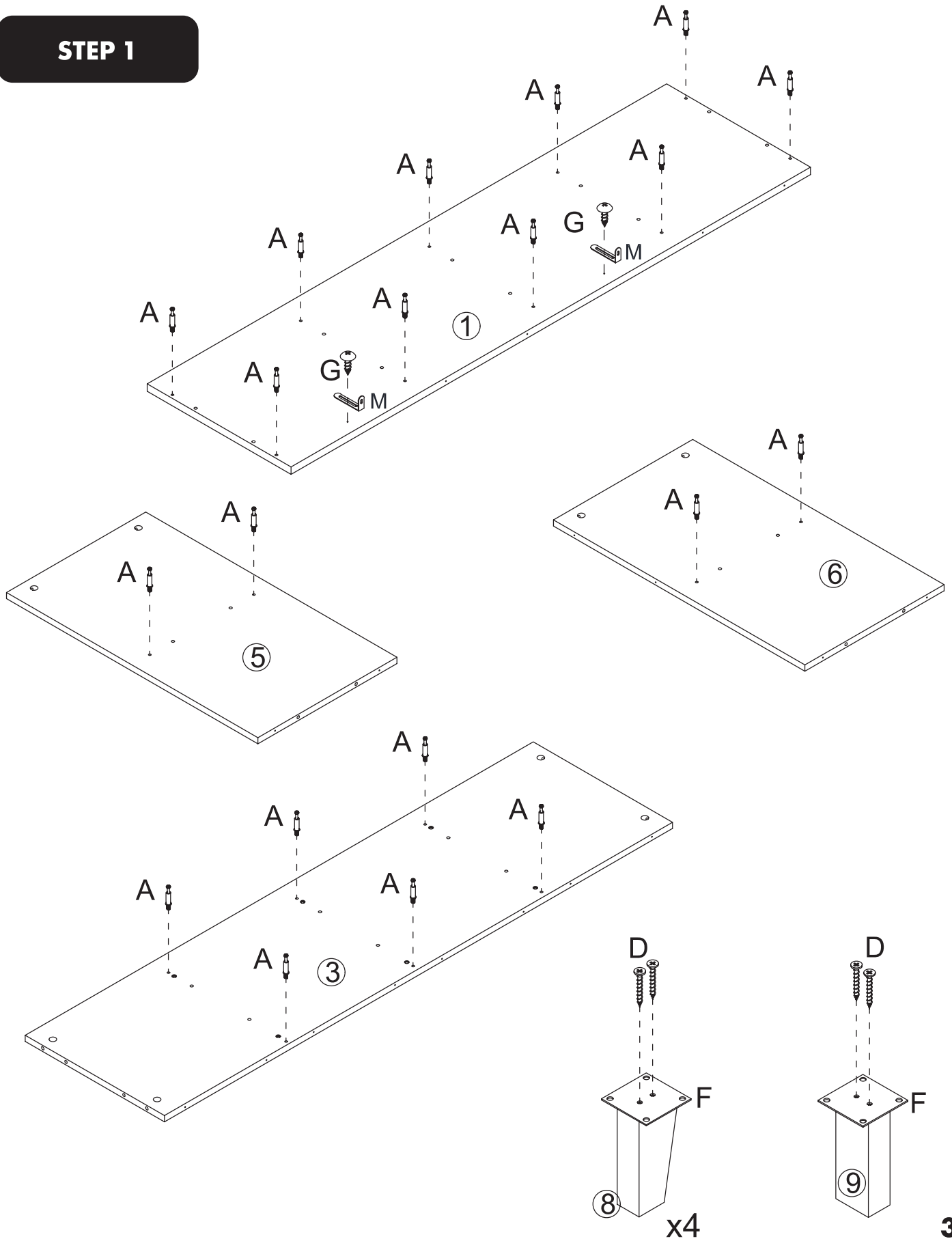

STEP 2

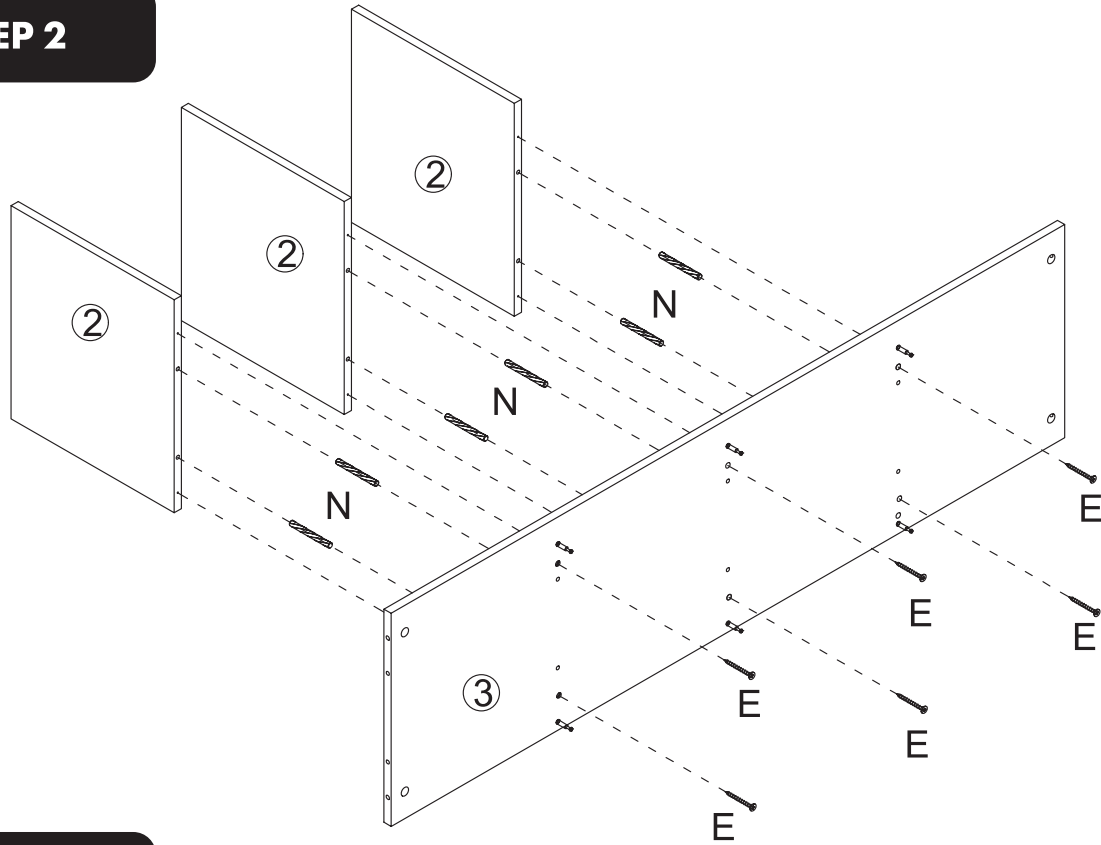

STEP 3

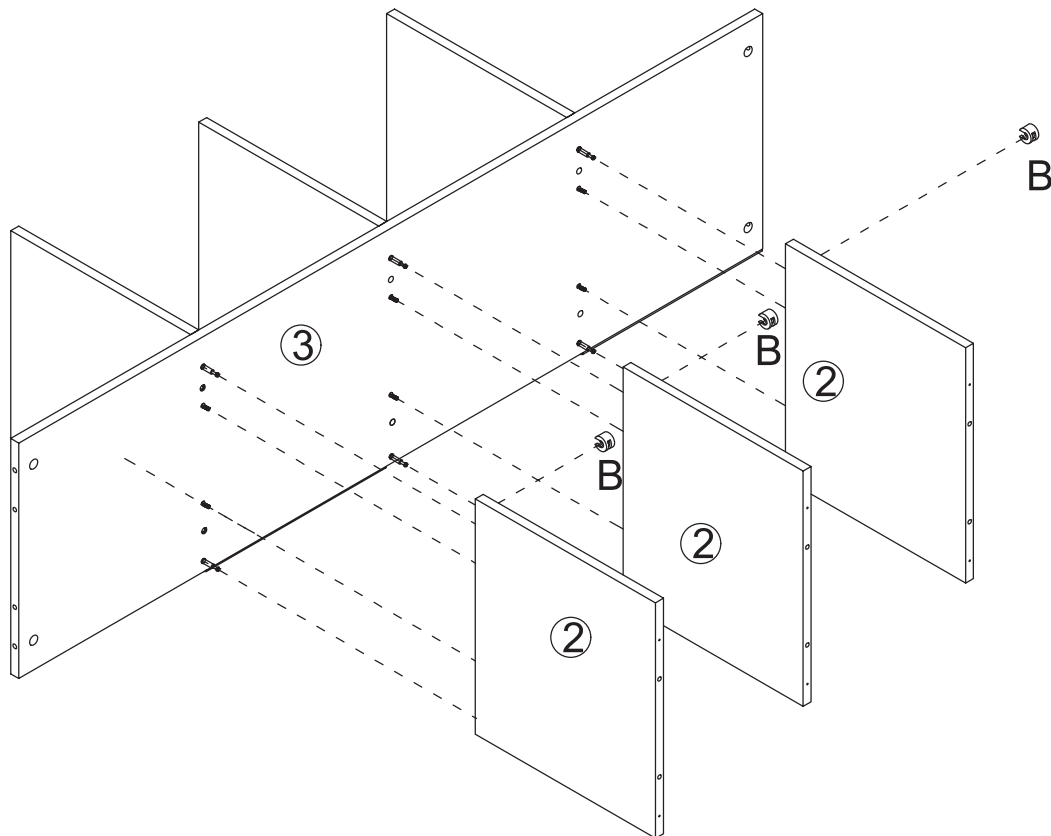

STEP 4

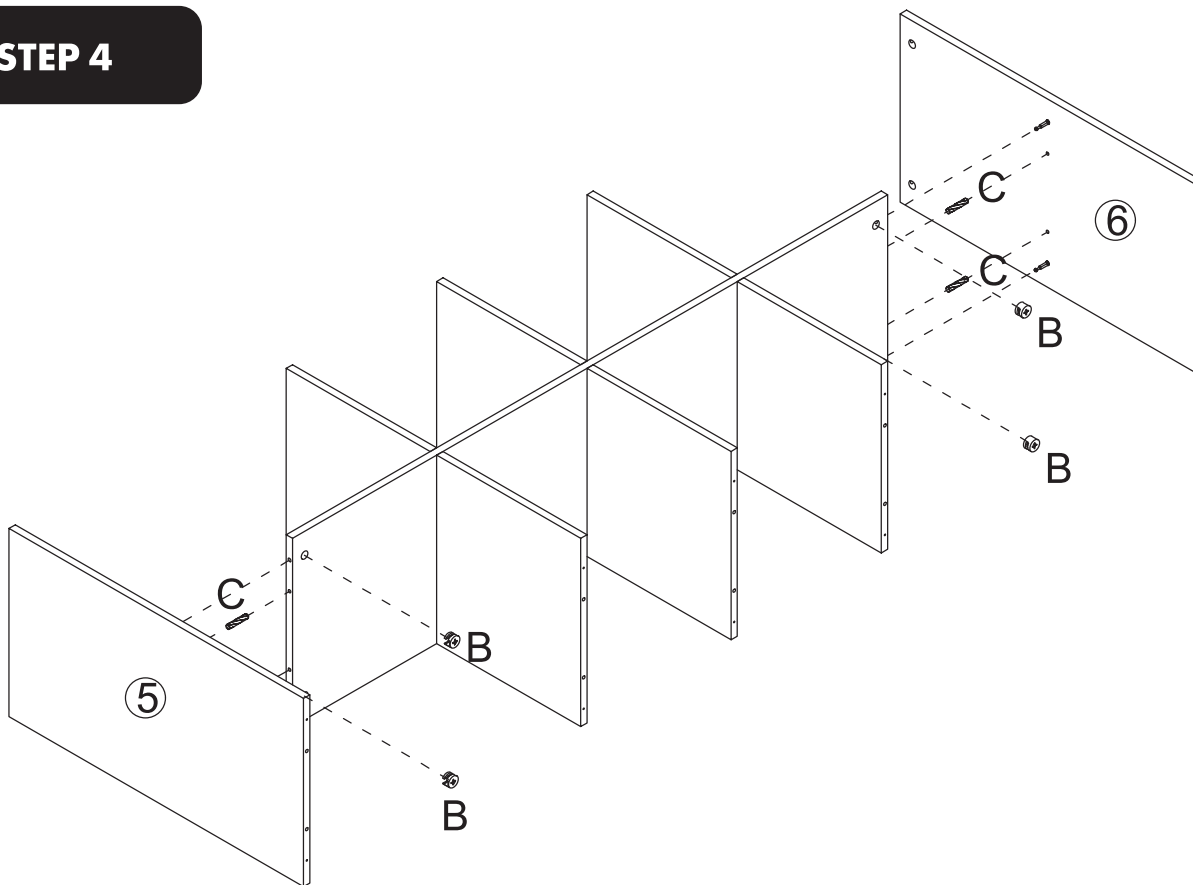

STEP 5

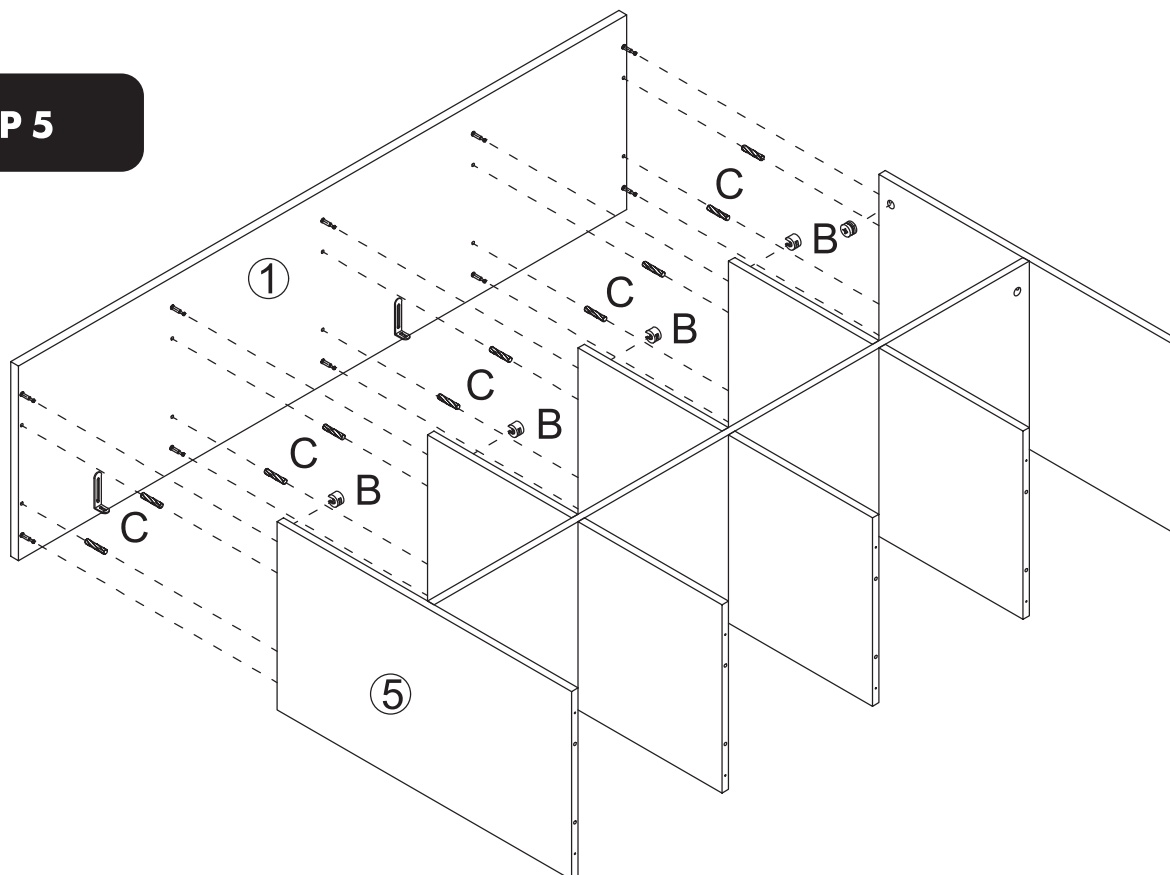

STEP 6

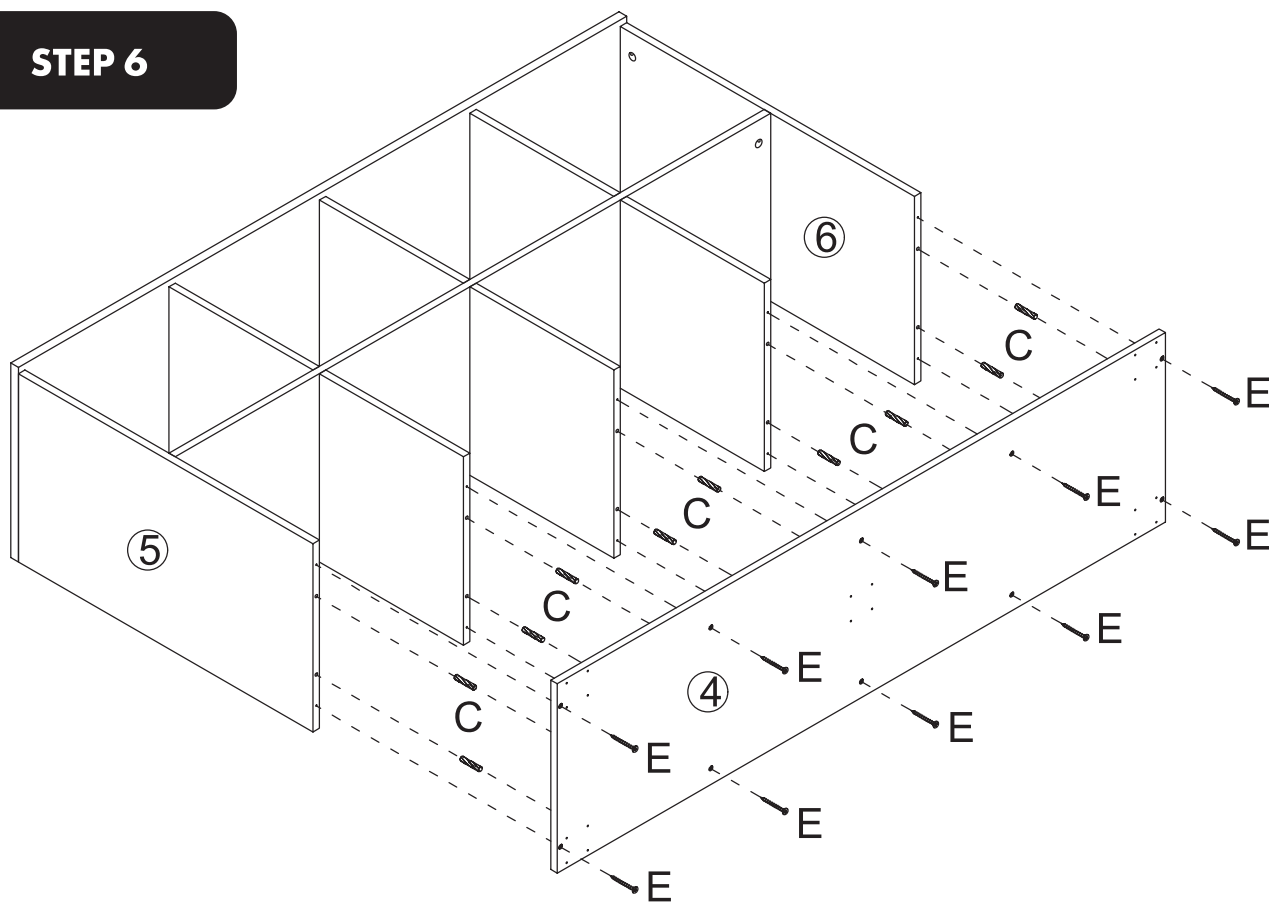

STEP 7

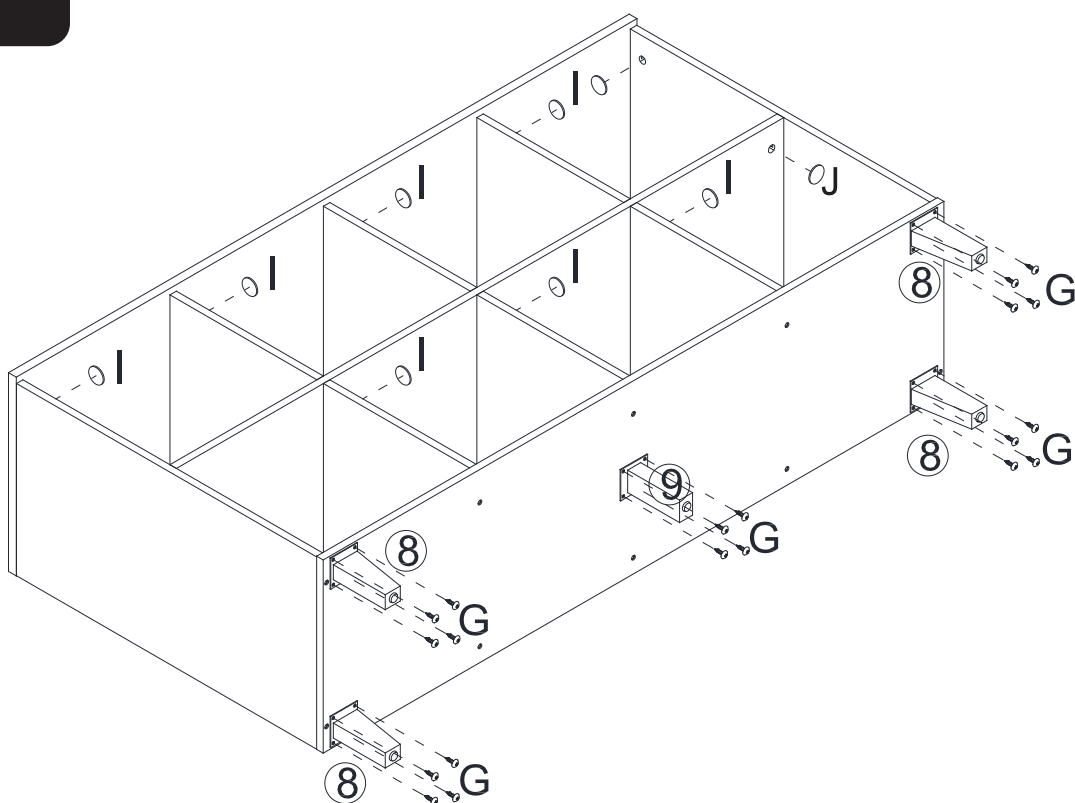

STEP 8

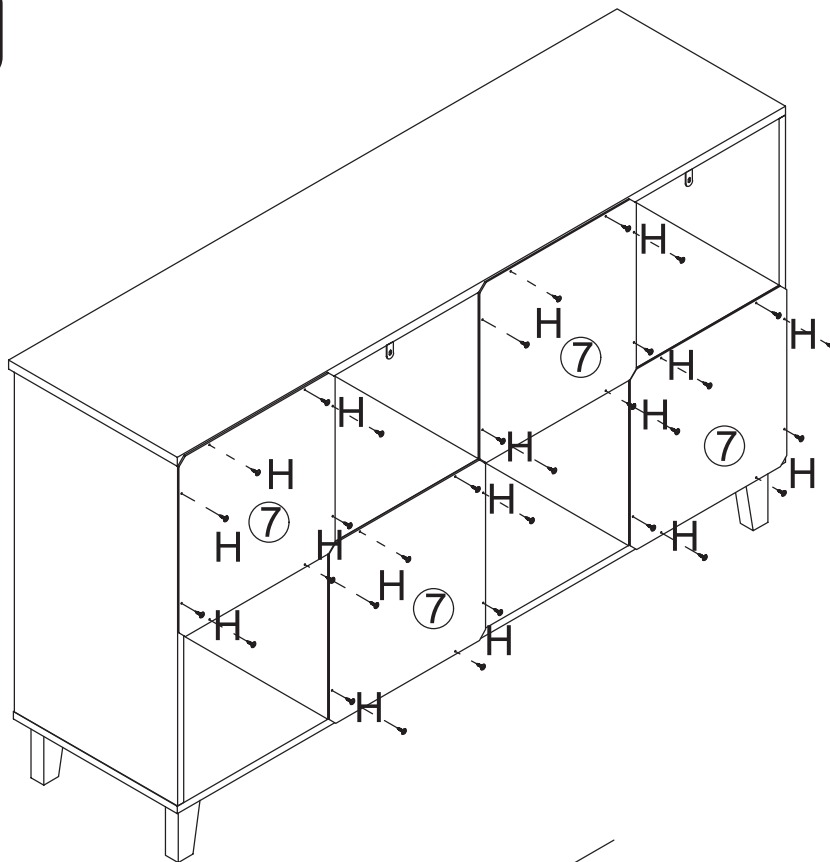

STEP 9

