

HOMEBASE

3 SEATER SWING

INSTRUCTION MANUAL



IMPORTANT: Please read these instructions before using the product and retain for future use.

HHGL Limited, MK9 1BA
HHGL (ROI) Limited, D02 X576

V1_2023

SAFETY AND CARE ADVICE

Please read these instructions fully before starting assembly.













- Check you have all the components and tools listed in this booklet before assembly.
- Remove all fittings from their plastic bags and separate them into their groups.
- Keep children and animals away from the work area; small parts could choke if swallowed.
- Make sure you have enough space to lay out the parts before starting.
- Do not stand or put weight on the component parts during assembly, as this could cause damage.
- Assemble on a soft, level surface to avoid damaging the unit or your floor.
- We recommend a two-person assembly.
- Dispose of all packaging carefully and responsibly.

IMPORTANT INFORMATION

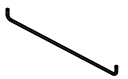

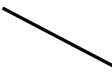

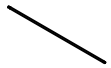









- Regularly check all the bolts, screws and fastenings are secure.
- Only clean using a damp cloth and mild detergent; do not use bleach or abrasive cleaners.

COMPONENTS - PANELS

Please check you have all components listed below. If you have any missing or damaged components, please contact your local store.

1		2 x Leg bases	8		2 x Armrest tubes
2		2 x Front legs	9		2 x Front hanging tubes
3		2 x Rear legs	10		2 x Rear hanging tubes
4		1 x Roof tube	11		1 x Rear crossing tube
5		1 x Seat & backrest	12		1 x Middle crossing tube
6		2 x Roof bending tubes	13		2 x Springs
7		2 x Roof straight tubes	14		1 x Roof fabric

COMPONENTS - FITTINGS

15		2 x M8*90 Bolts	22		6 x M8 Bolt caps
16		2 x M8*65 Bolts	23		8 x M6 Bolts caps
17		2 x M8*40 Bolts	24		6 x M8 Nutcaps
18		6 x M8 Locknuts	25		6 x M6 Nutcaps
19		6 x M6 Locknuts	26		2 x M8 Screws
20		12 x M8 Flat washers	27		4 x M6*80 Bolts
21		14 x M6 Flat washers	28		4 x M6*55 Bolts

Tools included

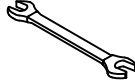
29		2 x M6 & M8 Spanners
----	---	----------------------

ASSEMBLY INSTRUCTIONS

Step 1

Insert the front legs (2) and rear legs (3) into the tubes of the curved leg base (1) then loosely attach the roof tube (4) to the front and rear leg tubes with M6 locknut (19) and the small flat washer (21) on one side, and bolt (28) and small flat washer (21) and a bolt cap (23) on the other side using the Spanner (29).

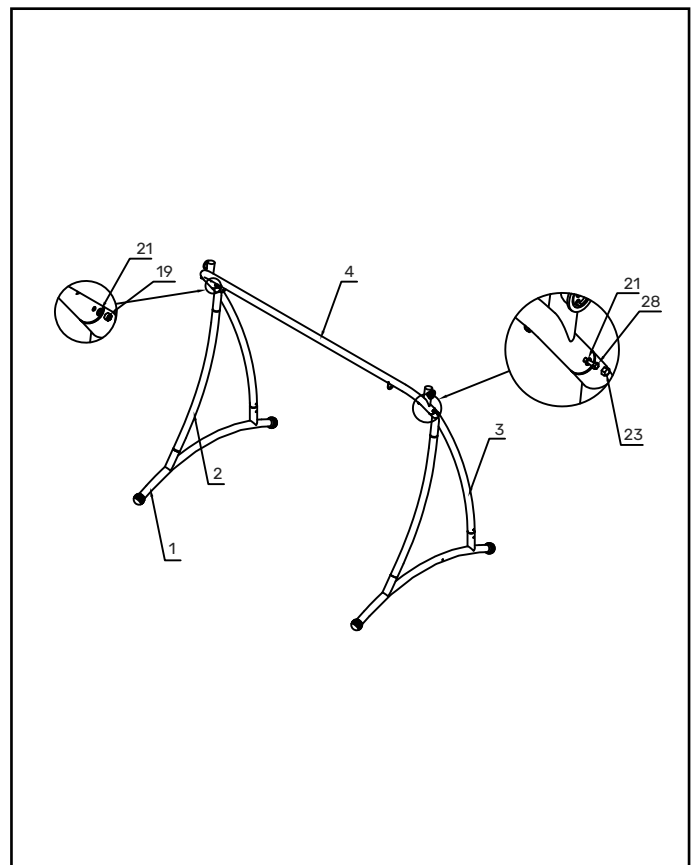

Step 2

Loosely attach the middle crossing tube (12) to the curved leg base with bolts (28), small flat washers (21) and bolt caps (23). Loosely attach the rear crossing tube (11) to the rear legs with bolts (27), small flat washers (21), bolt caps (23), M6 locknuts (19), small flat washers (21) and nut caps (25) using the spanner (29).

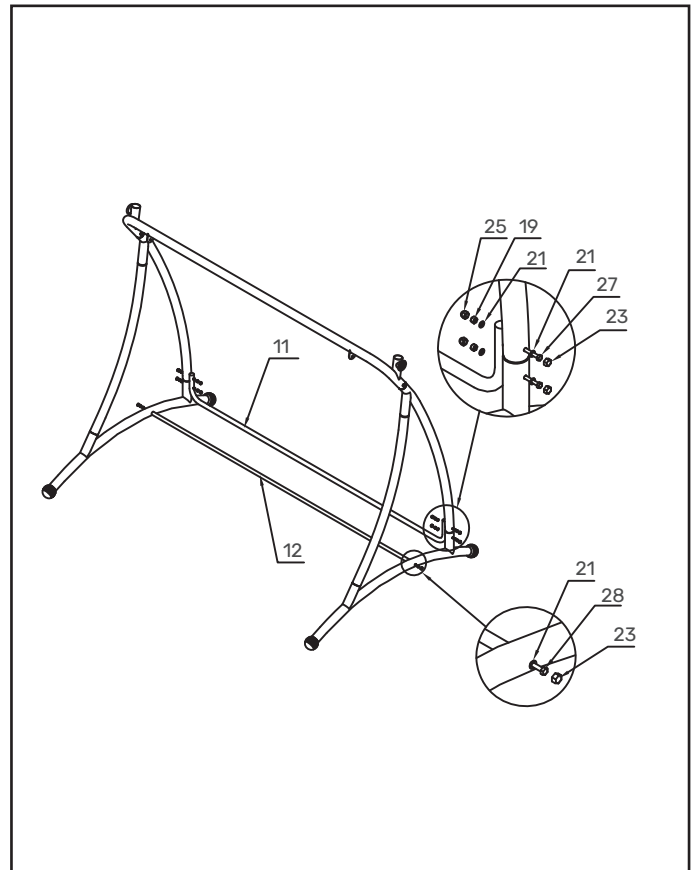

Step 3

Loosely attach both armrest tubes (8) to seating and backrest panel (5) with M8 locknut (18), big flat washers (20), M8 nut caps (24), bolts (16), big flat washers (20) and bolt caps (22) using the spanner (29). Loosely attach the upper front hanging tube (9) to the armrest with M8 locknut (18), big flat washers (20), M8 nut caps (24), bolts (17), big flat washers (20) and bolt caps (22) using the spanner (29). Loosely attach the upper rear hanging tube (10) to the armrest with bolts (15), big flat washers (20) and bolt caps (22). Place the springs (13) through the hole connecting the front and rear hanging tube using the spanner (29).

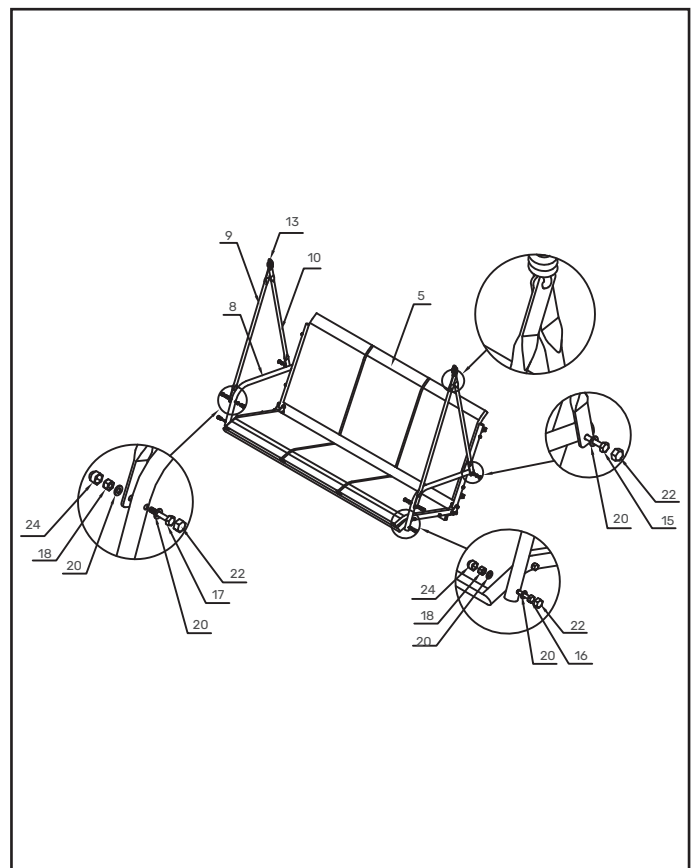

ASSEMBLY INSTRUCTIONS

Step 4

Hang the assembled seat onto the hook on the roof tube.

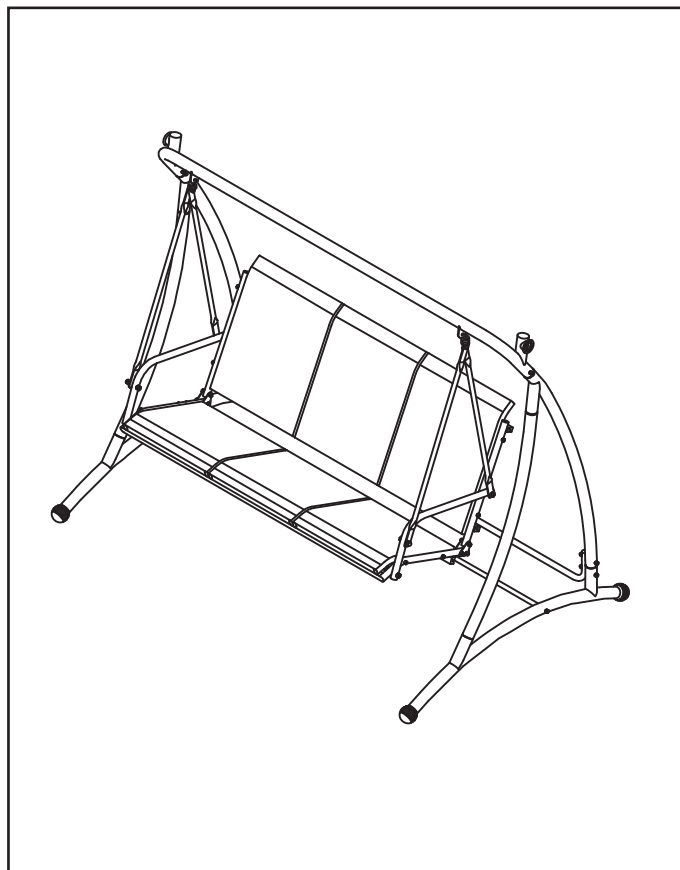

Step 5

Assemble the roof fabric cover (14) over the roof tube (6 & 7), then connect the roof tube (6 & 7) together. Finally, attach the assembled roof to the hanging swing with the adjustable screws (26) on both ends to fix it together securely.

