

HOMEBASE

FLORENCE 6 SEATER DINING TABLE

INSTRUCTION MANUAL



IMPORTANT: Please read these instructions before using the product and retain for future use.

HHGL Limited, MK9 1BA
HHGL (ROI) Limited, D02 X576

V1_2023

SAFETY AND CARE ADVICE

Please read these instructions fully before starting assembly.





- This product is made from toughened glass, which is strong but not unbreakable. In the unlikely event that the glass fails, it will break into a large number of small fragments that may be spread over a wide area. This is a feature of toughened glass, and is designed to remove the risk of injury from glass breaking into large shards.
- If the glass is chipped or broken, stop using the product.
- Tables should not be dragged at any time.
- Do not strike or place heavy weight on the table.
- Do not place hot items directly onto the glass.
- Avoid dropping objects on the glass, as this may weaken or shatter it.
- Do not use the glass as a chopping surface.
- Do not strike the glass with hard or pointed items.
- Check you have all the components and tools listed in this booklet before assembly.
- Remove all fittings from their plastic bags and separate them into their groups.
- Keep children and animals away from the work area; small parts could choke if swallowed.
- Make sure you have enough space to lay out the parts before starting.
- Do not stand or put weight on the component parts during assembly, as this could cause damage.
- Assemble on a soft, level surface to avoid damaging the unit or your floor.
- Dispose of all packaging carefully and responsibly.

IMPORTANT INFORMATION

- Regularly check all the bolts, screws and fastenings are secure.
- Only clean using a damp cloth and mild detergent; do not use bleach or abrasive cleaners.

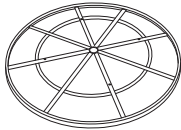
COMPONENTS - PANELS

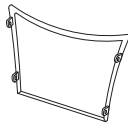





Please check you have all components listed below. If you have any missing or damaged components, please contact your local store.

A	 Table top	1
B	 Table legs	2
C	 Side panels	2
D	 Glass top	1

COMPONENTS - FITTINGS

Please check you have all fittings listed below. If you have any missing or damaged fittings, please contact your local store.

Note: The quantities below are the correct amount to complete the assembly. In some cases, more fittings may be supplied than required.

E	 Bolts M6x20	4
F	 Flat washers	12
G	 Lock washers	12
H	 Bolt caps	12
I	 Bolts M6x40	8
J	 Plastic washers	8

Tools Included

K	 Spanner	1
---	---	---

ASSEMBLY INSTRUCTIONS

Step 1

Attach legs (B) to side panels (C) with bolts (I), plastic washers (J), flat washers (F) and lock washers (G) using spanner (K). Don't tighten bolts completely at this stage.

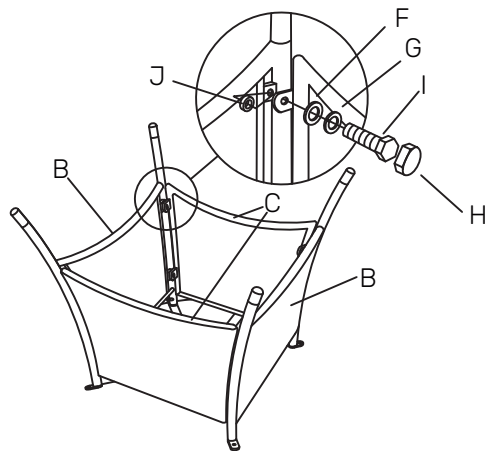

Step 2

Turn the table top (A) upside down on a soft clean surface.

Attach assembled leg section to table top with bolts (E), flat washers (F) and lock washer (G) using spanner (K).

Using the spanner, tighten all bolts one by one, being careful not to over tighten any, as this will cause the thread to become damaged. Place bolt caps (H) on all visible bolts (E) and (I).

Turn table top over and place in desired position, place glass (D) on table and gently press down on suckers to ensure glass is secure.

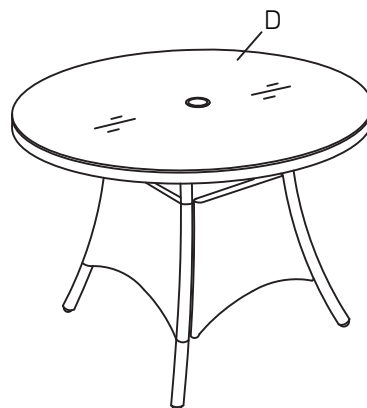
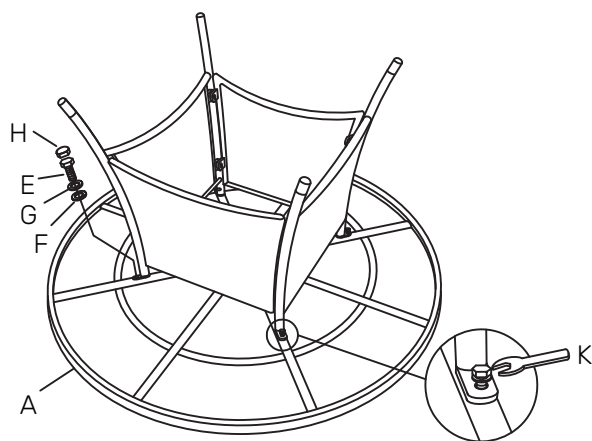

ASSEMBLY COMPLETE