

**HOMEBASE**

# GAZEBO WITH EXTENDING PANELS

Powder-coated steel frame

Includes 1 x gazebo and panels

H265 x W250 x D250cm

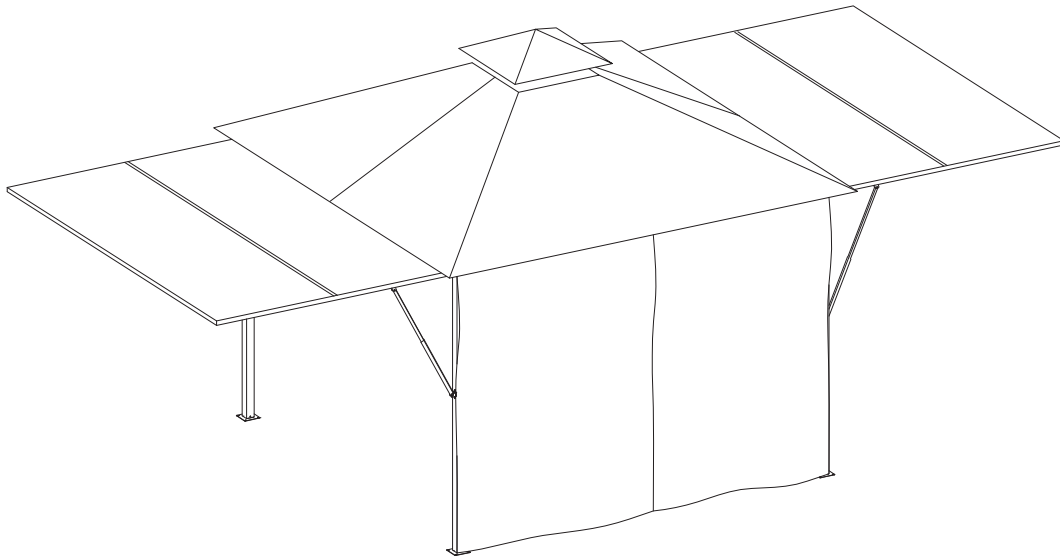

## INSTRUCTION MANUAL

**IMPORTANT:** Please read these instructions before using the product. Retain instructions for future use.

HHGL Limited, MK9 1BA HHGL (ROI) Limited, D02 X576

## SAFETY & CARE ADVICE

Please read these instructions fully before starting assembly.

- Check you have all the components and tools listed on page 3, 4 and 5 .
- Remove all fittings from the plastic bags and separate them into their groups.
- Keep children and animals away from the work area; small parts could choke if swallowed.
- Make sure you have enough space to lay out the parts before starting.
- Do not stand or put weight on the component parts and product, as this could cause damage.
- Assemble the item as close to its final position as possible.
- Assemble on a soft, level surface to avoid damaging the unit or your floor.
- Parts of the assembly will be easier with two people.
- We do not recommend the use of power drills/drivers for inserting screws, as this could damage the unit. Only use hand screwdrivers.



- Dispose of all packaging carefully and responsibly.
- Only clean using a damp cloth and mild detergent; do not use bleach or abrasive cleaners.
- From time to time, check that there are no loose screws on this unit.
- This product should not be discarded with household waste. Take to your local authority waste disposal centre.
- Domestic use only.
- **ATTENTION:** To avoid damage, disassemble the gazebo during bad weather, e.g. during high wind or heavy rain.  
This product is intended to be used as a temporary shelter and is not designed to be used as a permanent structure.

## COMPONENTS - PANELS

Please check you have all components listed below. If you have any missing or damaged components, please contact your local store.

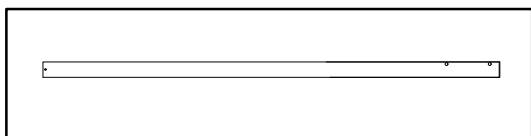

1 x 2

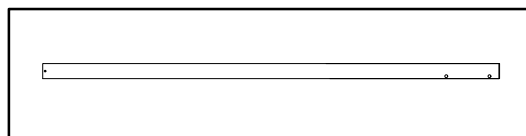

2 x 2

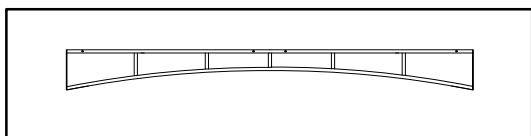

3 x 2

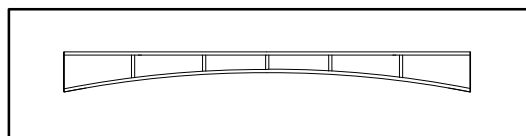

4 x 2

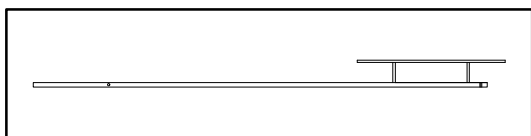

5 x 4

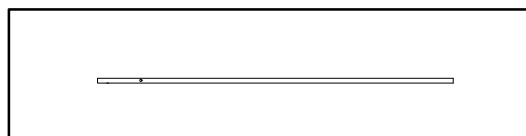

6 x 4

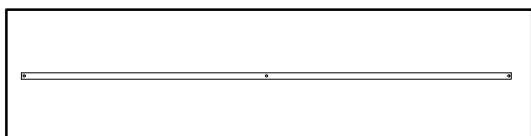

7 x 4

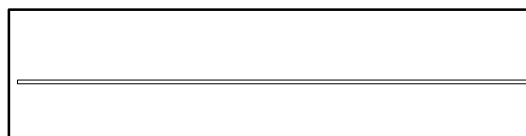

8 x 6

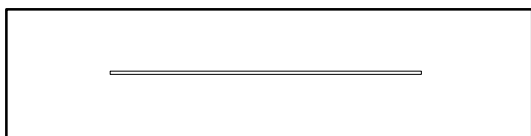

10 x 4

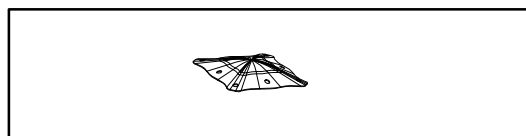

11 x 1

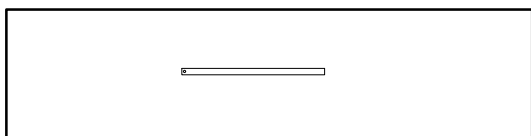

12 x 4

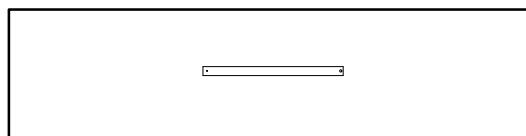

13 x 4

## COMPONENTS - PANELS

Please check you have all components listed below. If you have any missing or damaged components, please contact your local store.

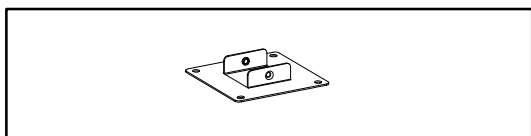

14 x 4

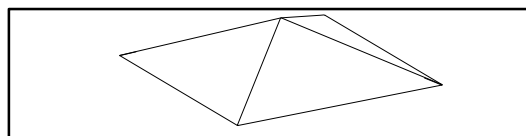

16 x 1

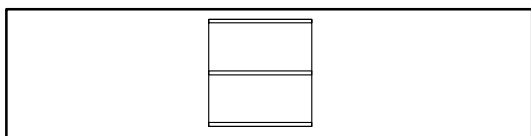

17 x 2

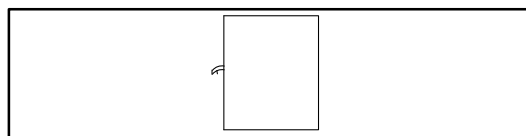

18 x 2

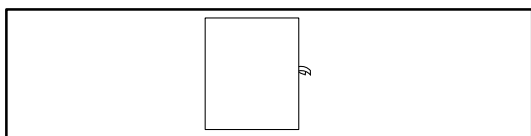

19 x 2

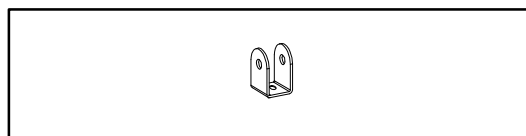

20 x 8

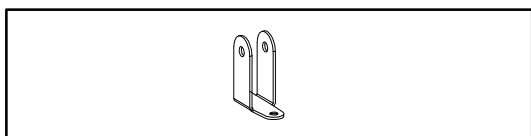

21 x 4

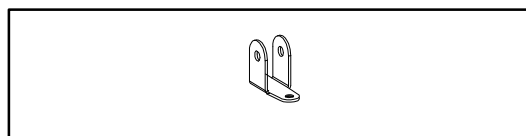

22 x 4

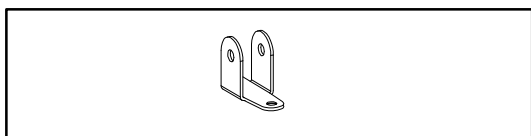

23 x 4

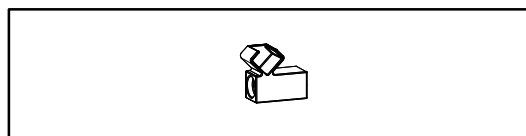

24 x 4

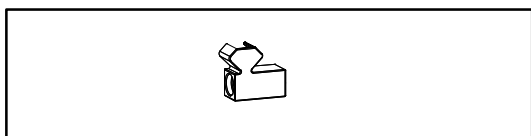



25 x 4

# COMPONENTS - FITTINGS

Please check you have all fittings listed below. If you have any missing or damaged fittings, please contact your local store.

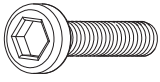
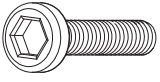
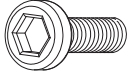
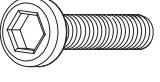
Note: The quantities below are the correct amount to complete the assembly. In some cases, more fitting may be supplied than required.

|  |   |
|--|---|
| <p><b>L1</b></p>  <p>M6 x Metal nut x 24</p>  | <p><b>L1</b></p>  <p>M6 x 30mm Bolt x 24</p> |
| <p><b>L2</b></p>  <p>M6 x 35mm Bolt x 16</p>  | <p><b>L3</b></p>  <p>M6 x 15mm Bolt x 56</p> |
| <p><b>L4</b></p>  <p>M6 x 40mm Bolt x 4</p> | <p><b>L5</b></p>  <p>Nails x 8</p>         |

## Tools required



4mm Hex key (included)



10mm Nut wrench (included)

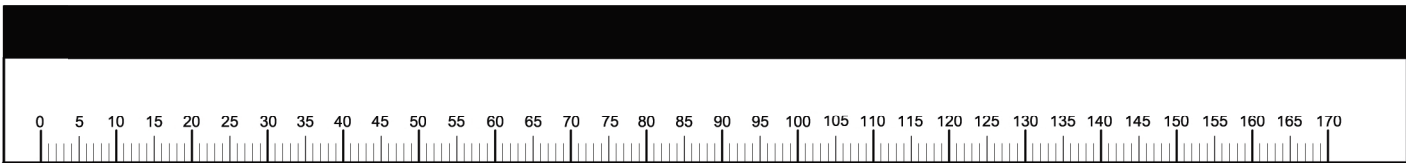

# ASSEMBLY INSTRUCTIONS

## Attention:

Make sure that each bolt needed for all steps matches the corresponding figure to ensure proper assembly.

## Step 1

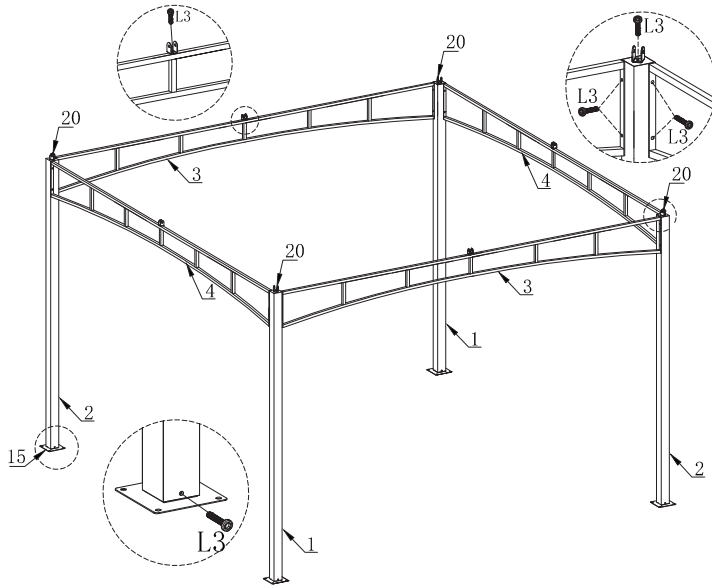

## Step 2

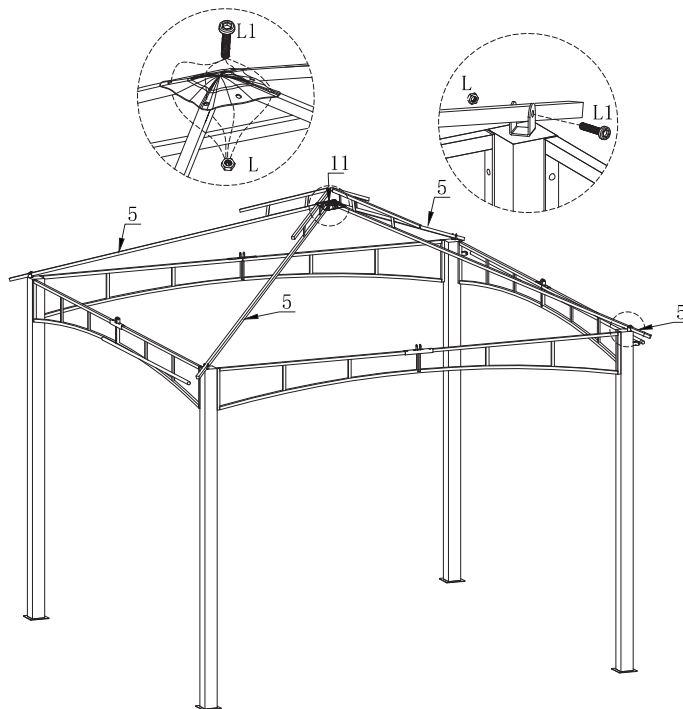

Step 3

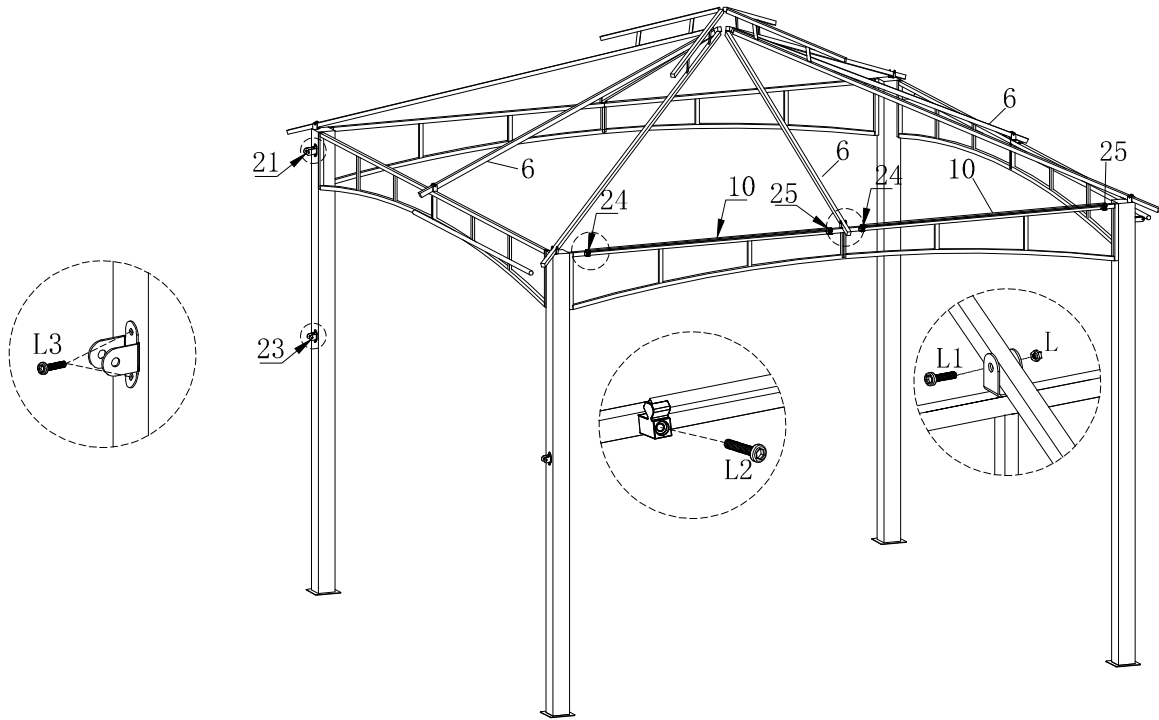

Step 4

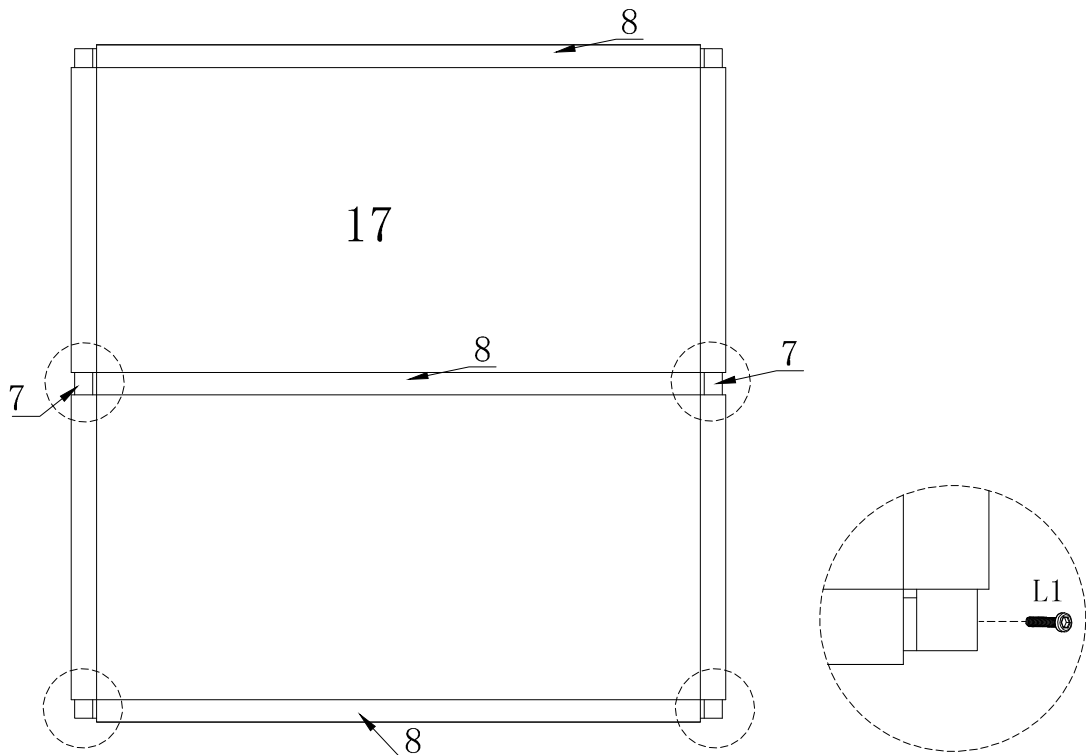

**Step 5**

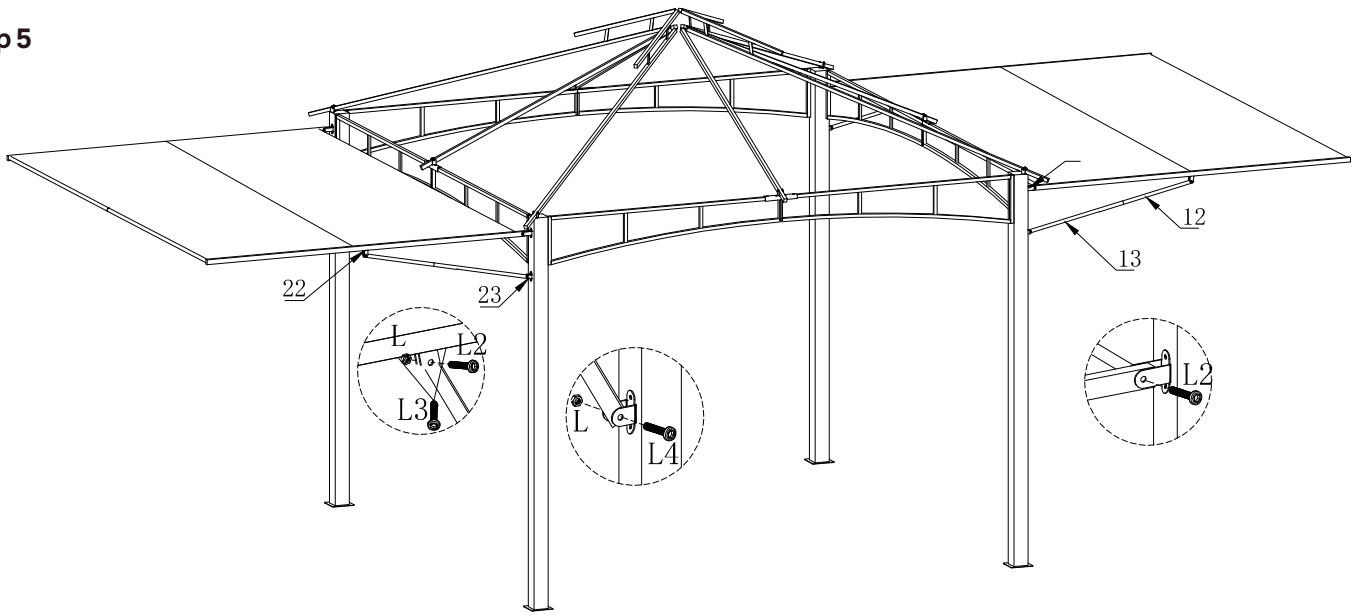

**Step 6**

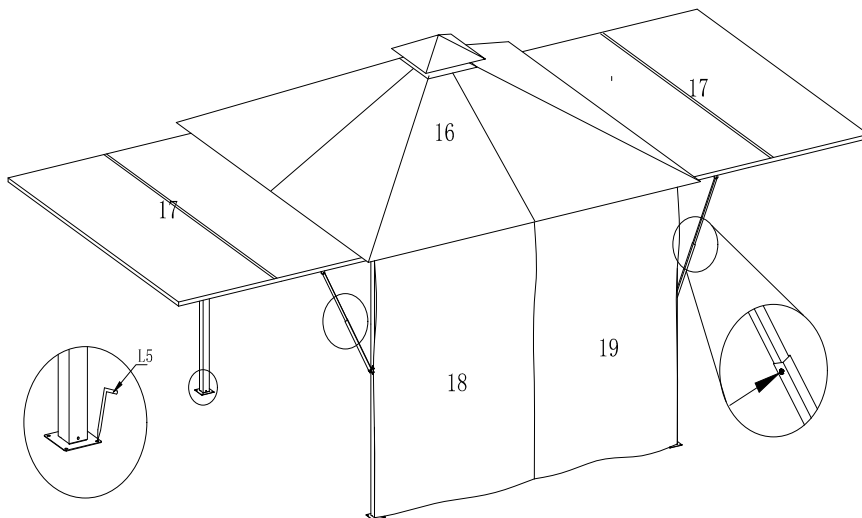



**Step 7**

