

HOMEBASE

PARTY GAZEBO

3M X 6M

Powder-coated steel frame
Includes 1 x gazebo and carry bag
H260 x W600 x D300cm

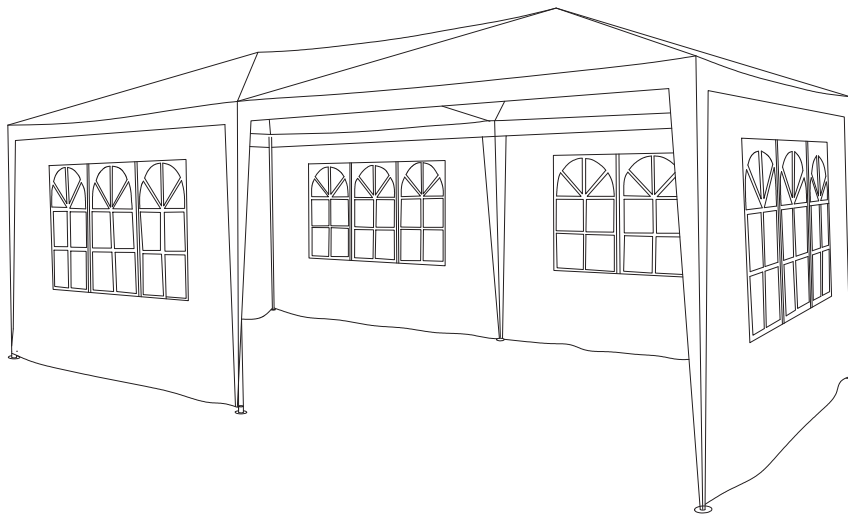

INSTRUCTION MANUAL

IMPORTANT: Please read these instructions before using the product and retain for future use.

HHGL Limited, MK9 1BA HHGL (ROI) Limited, D02 X576

SAFETY & CARE ADVICE

Please read these instructions fully before starting assembly.

- Check you have all the components and tools listed on page 3 .
- Remove all fittings from the plastic bags and separate them into their groups.
- Keep children and animals away from the work area; small parts could choke if swallowed.
- Make sure you have enough space to lay out the parts before starting.
- Do not stand or put weight on the component parts and product, as this could cause damage.
- Assemble the item as close to its final position as possible.
- Assemble on a soft, level surface to avoid damaging the unit or your floor.
- Parts of the assembly will be easier with two people.
- We do not recommend the use of power drills/drivers for inserting screws, as this could damage the unit. Only use hand screwdrivers.



- Dispose of all packaging carefully and responsibly.
- Only clean using a damp cloth and mild detergent; do not use bleach or abrasive cleaners.
- From time to time, check that there are no loose screws on this unit.
- This product should not be discarded with household waste. Take to your local authority waste disposal centre.
- Domestic use only.
- **ATTENTION:** To avoid damage, disassemble the gazebo during bad weather, e.g. during high wind or heavy rain.
This product is intended to be used as a temporary shelter and is not designed to be used as a permanent structure.

COMPONENTS - PANELS

Please check you have all components listed below. If you have any missing or damaged components, please contact your local store.

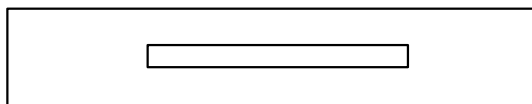

1 x 8

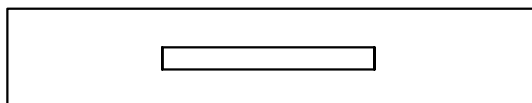

3 x 6

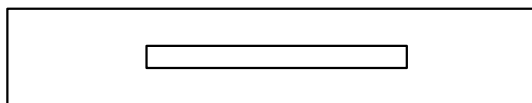

5 x 6

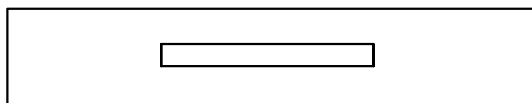

7 x 1



A x 4

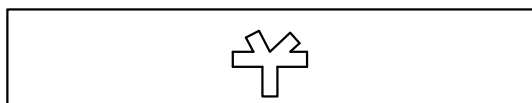

C x 2

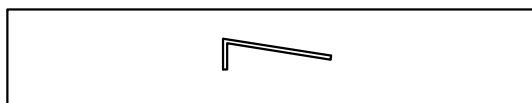

E x 12

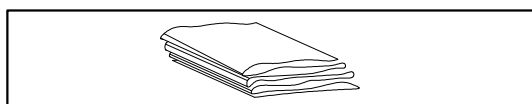

G x 1

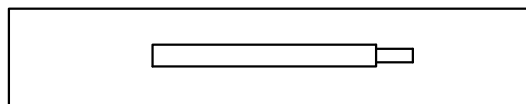

2 x 10

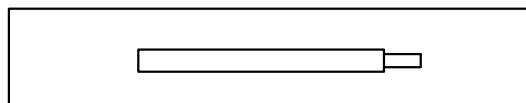

4 x 12

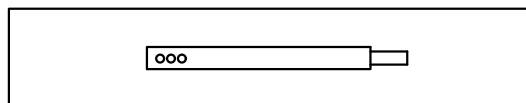

6 x 6

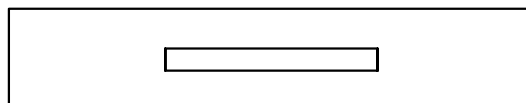

8 x 2

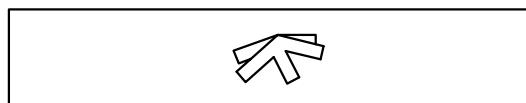

B x 2

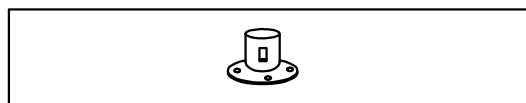

D x 6

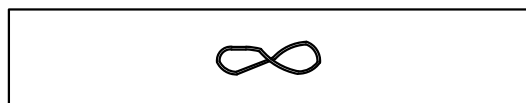

F x 6

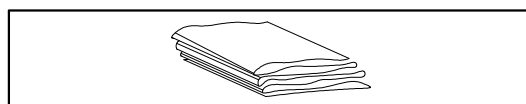

H x 5

ASSEMBLY INSTRUCTIONS

Attention:

Make sure that each part needed for all steps matches the corresponding figure to ensure proper assembly.

Step 1

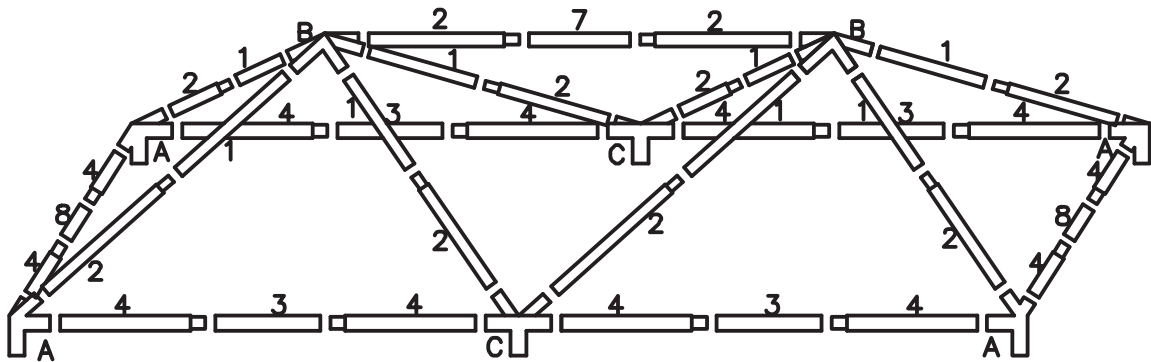

Step 2

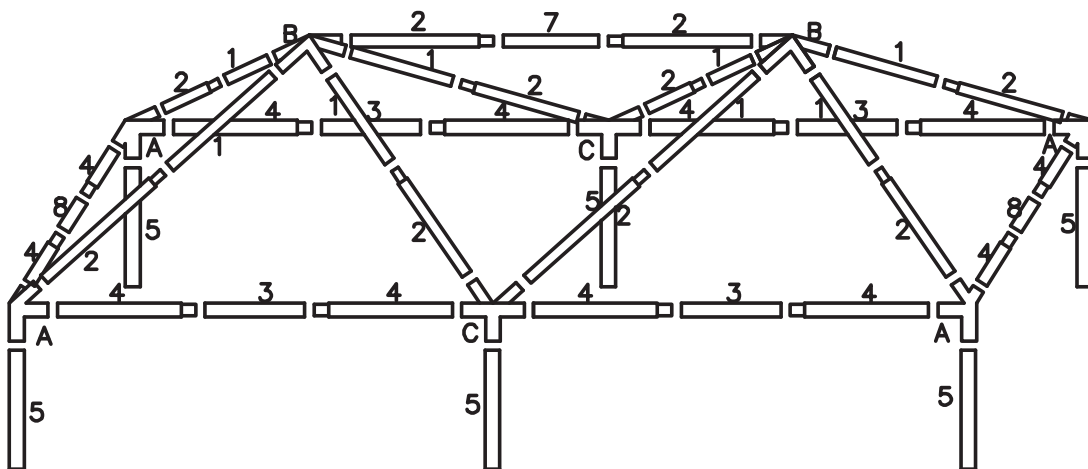

Step 3

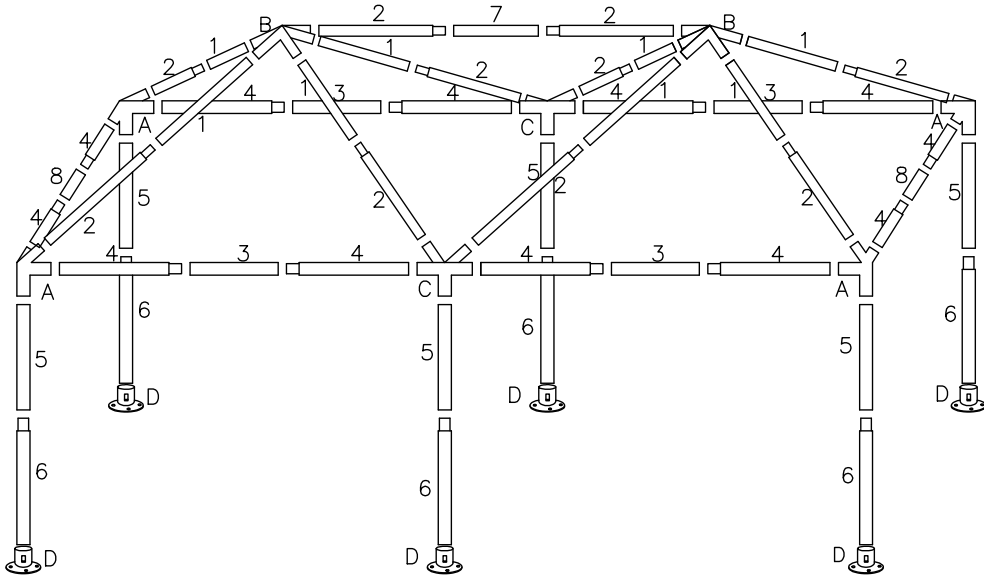

Step 4

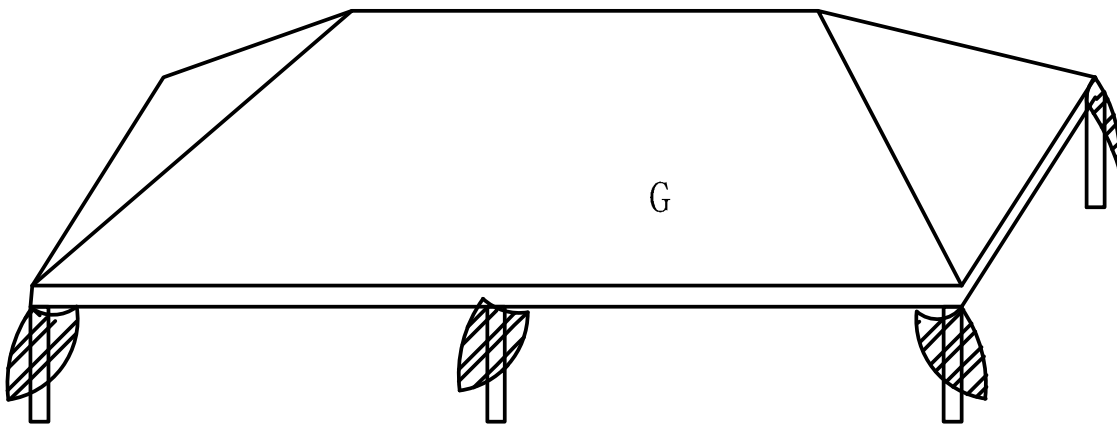

Step 5

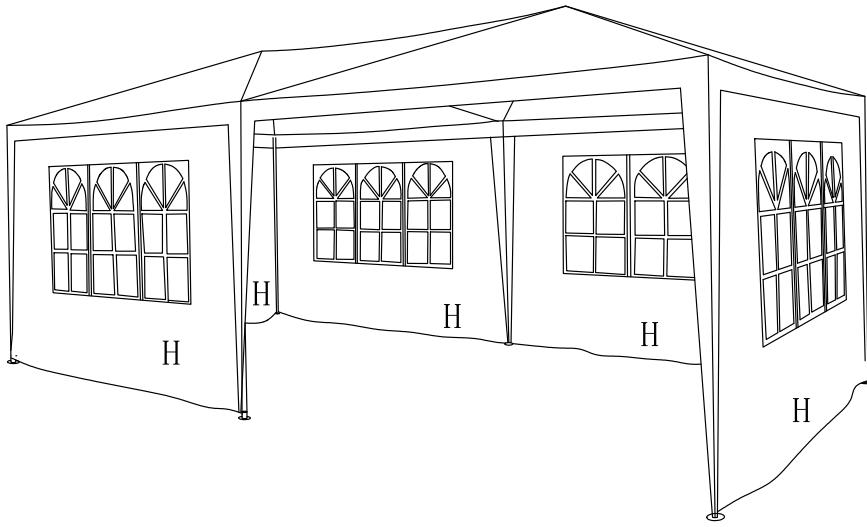

Step 6

