

POWERBASE

42cm 42.7cc Petrol
Brush Cutter

577159

Instruction Manual

IMPORTANT!
Please read these
instructions fully before
starting assembly.

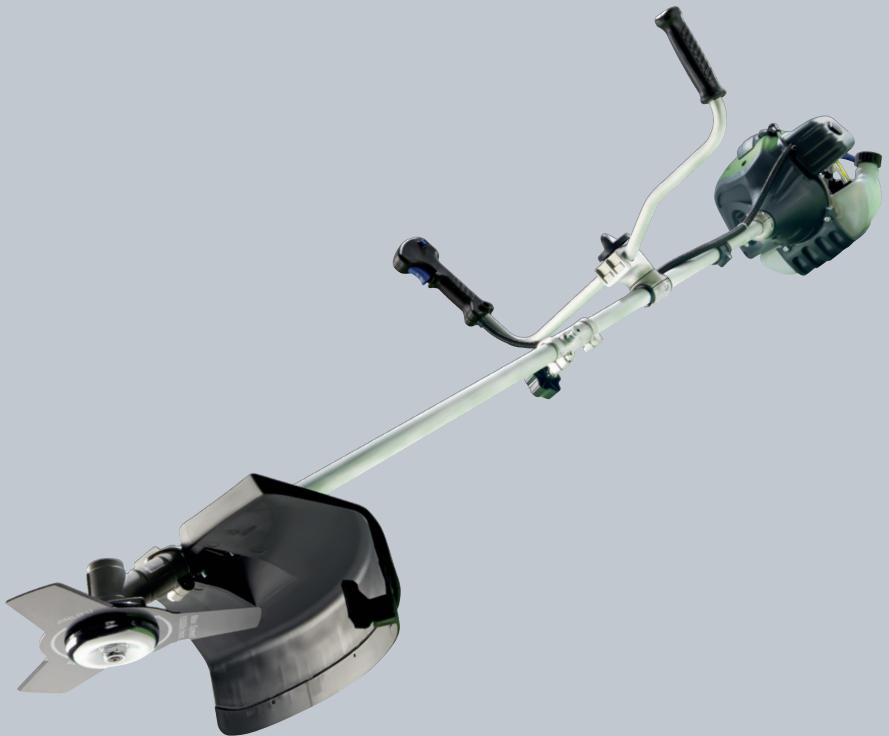

These instructions contain important information that will help you get the best from your product, ensuring it is assembled correctly and safely. If you need help or have damaged or missing parts, call the Customer Helpline on 01904 727 509.

Contents

General safety warnings	3
Intended use	10
Warning symbols	10
In the box	12
Assembly	14
Preparation	19
Operation	20
Maintenance and storage	26
Troubleshooting	33
Technical data	34
Disposal	35
Getting help	35
Warranty	35

General Safety Warnings

Safety warnings



WARNING! Read all safety warnings and instructions.

Failure to follow the warnings and instructions may result in serious injury. Save all warnings and instructions for future reference.

- Always ensure anyone intending to operate this machine is fully conversant with the contents of this instruction manual prior to assembling, maintaining or operating the machine.
- Perform assembly operations exactly as described in this manual. Failure to observe this warning may lead to serious injury, death, or damage to the machine.
- Always take care when removing the packaging, to prevent damage to you or to the machine.

IMPORTANT! Before assembling the machine, check all the parts indicated in the manual are in the box. Inspect all the parts for signs of damage. Do not assemble the machine if you observe any damaged components.

NOTE! This machine complies with the Noise Emission Directive 2000/14/EC.

General safety

- Keep this operating and maintenance manual in a safe place for reference at a later date.
- Read the instructions carefully. Be familiar with the controls and the proper use of the cutter.
- Never allow children or people unfamiliar with the instructions to use the machine. Local regulations can restrict the age of the operator.
- Never trim while people, especially children or pets, are nearby. Keep in mind that the operator or user is responsible for accidents or hazards occurring to other people or their property.
- This cutter is not intended for use by people (including children) with reduced physical, sensory or mental capabilities, or lack of experience and knowledge, unless they have been given supervision or instruction concerning the use of the cutter by a person responsible for their safety.
- Do not touch the rotating spool.

Personal safety

- Do not allow children or untrained individuals to use this cutter.
- Never start or run the engine in an enclosed or poorly-ventilated area; breathing exhaust fumes can kill.

- Clear the work area before each use. Remove all objects, such as rocks, broken glass, nails, wire, or other such debris, which can be thrown or become entangled in the cutting line.
- Wear safety glasses or goggles when operating this machine.
- Wear suitable, long trousers, boots, and gloves. Do not wear loose fitting clothing, shorts, or go barefoot. Do not wear jewellery of any kind.

Operation safety

- Never operate this unit on the operator's left side.
- Long hair below shoulder level should be secured, to prevent entanglement in moving parts.
- Keep all bystanders, children and pets at least 15m (50ft.) away.
- Do not operate the cutter when you are tired, ill, or under the influence of alcohol, drugs, or medication.
- Do not operate the cutter in poor lighting.
- Keep firm footing. Do not overreach. Overreaching can result in loss of balance or exposure to hot surfaces.
- Keep your body away from any moving parts.
- To avoid hot surfaces, never operate the unit with the bottom of the engine above waist level.

- Do not touch the area around the exhaust or cylinder of the unit; these parts get hot during operation.
- Always stop the engine and remove the spark plug wire before making any adjustments or repairs, except for carburettor adjustments.
- Inspect the unit for loose fasteners, fuel leaks, etc., before each use. Replace any parts found to be worn or damaged.
- The string head will rotate during carburettor adjustments and engine starting.
- It has been reported that vibrations from hand-held tools may, in certain individuals, contribute to a condition called Raynaud's Syndrome. Symptoms may include: tingling, numbness and blanching of the fingers, usually apparent upon exposure to cold. Hereditary factors, exposure to cold and dampness, diet, smoking and work practices are all thought to contribute to the development of these symptoms. It is presently unknown what, if any, vibrations or extent of exposure may contribute to the condition. Measures can be taken by the operator to possibly reduce the effects of vibration:
 - a. Keep your body warm in cold weather. When operating the unit, wear gloves to keep the hands and wrists warm. It is reported that cold weather is a major factor contributing to Raynaud's Syndrome.

- b. After each period of operation, exercise to increase blood circulation.
 - c. Take frequent work breaks. Limit the amount of exposure per day.
 - d. Keep the cutter well maintained, fasteners tightened and worn parts replaced.
- If you experience any of the symptoms of this condition, immediately discontinue use and see your doctor.
 - Mix and store fuel in a container approved for petrol clearly identified as 2-stroke.
 - Mix fuel outdoors where there are no sparks or flames. Wipe up any fuel spillage. Move 10m (30ft.) away from the refuelling site before starting the engine.
 - Stop the engine and allow it to cool before refuelling or storing the unit.
 - Before transporting in a vehicle, allow the engine to cool, empty the fuel tank and secure the cutter from moving.
 - Replace the string head if cracked, chipped, or damaged in any way. Be sure the string head is properly installed and securely fastened. Failure to do so can cause serious injury.
 - Make sure all guards, straps, and handles are properly and securely attached.
 - Use only the manufacturer's replacement string in the cutting head. Do not use any other cutting attachment. To install any other brand of cutting head to this string cutter may result in serious personal injury.

- Never operate the unit without the grass guard in place and in good condition.
- Maintain a firm grip on both handles while trimming. Keep the string head below waist level. Never cut with the string head located over 76cm (30in.) above the ground.

Using brush cutter attachment safely



WARNING! Danger of injury! The machine must not be used to cut hedges, hard branches and wood, or to crush material for compost. Do not use it to cut grass that is not on the ground, e.g. grass growing on walls, rocks, etc.



WARNING! Danger of injury! Rotating blades may lead to serious injuries by cutting or amputating parts of the body.

- Always have your arms and legs a safe distance from the cutting mechanism, in particular after turning the engine on.
- Never touch under the housing body when the engine is running. Safety gloves must be used!
- Never use the brush cutter without the protective cover.
- After the cutter is turned off, the cutting head keeps rotating for a couple of seconds. Keep your arms and legs at a safe distance.

- Always carry the machine by its handle, keeping a safe distance from the blade to avoid the risk of injury.



WARNING! Sharp blades! Take extra care to avoid injury by the rotating blades.

- Never cross any gravel roads or paths whilst the machine is running.

Maintenance



WARNING! Switch off the engine before carrying out any work. Wait until all rotating parts have stopped and the cutter has cooled down.

1. Repairs and works specified in these Instructions may only be performed by qualified authorised staff. Use only original accessories and spare parts.
2. Keep the cutter clean at all times, in particular the air vents. Never spray water on the cutter body! Never clean the cutter and its components with solvents, or flammable or toxic liquids. Use only a damp cloth.
3. Check the cutting equipment function.
4. Only a regularly maintained and well treated cutter can serve as a satisfactory aid. Insufficient maintenance and care can lead to unforeseen accidents and injuries.

Intended Use

- This machine is designed to be used as a brush cutter for trimming grass and light foliage.
- For non-commercial use!

Non-intended use:

This machine is not designed for trimming hedges or any other task whereby the machine has to be raised over a 30° angle.

Thrown-off stones or soil may lead to injuries.

The machine uses a rotating cutting tool. Through this rotational motion, debris can be thrown from the cutting head of the unit, e.g. stones and sticks.

Warning Symbols

The following warning symbols appear throughout this manual and indicate the appropriate safety measures you should take when operating and maintaining the machine.



Read the instructions and following warnings and safety instructions.



Wear eye and hearing protection (PPE). Where this is a risk of falling objects, wear head protection.



Wear protective gloves.



Wear slip-resistant footwear.



When working, the distance between the machine and bystanders shall be at least 15m.



Maximum permitted rotational speed of the cutting tool.



Warning! Hot surface - Burns to fingers or hands.



The product complies with the applicable European directives and an evaluation method of conformity for these directives was done.



The product complies with the applicable UK directives and an evaluation method of conformity for these directives was done.



Guaranteed sound power level data (114dB), in accordance with Directive 2006/42/EC.



Beware of thrown objects.



Beware of blade thrust!



Maximum permitted rotational speed of the cutting blade.



'I' means ON

'O' means OFF



Choke. Move choke lever to 'RUN' position. See Starting and Stopping Engine Section.



Choke. Move choke lever to 'CHOKE' position. See Starting and Stopping Engine Section.

In the Box

Parts

1. Line spool with cutting line
2. Safe guard
3. Lower shaft
4. Cutting blade
 - 4a. Blade sleeve
5. Steady grip
6. Switch On/Off
7. Throttle lock
8. Throttle lever
9. Fuel pump
10. Choke lever
11. Starter
12. Spark plug boot
13. Air filter housing cover
14. Petrol tank
15. Housing for engine cooler strap
16. Harness
17. Fuel mixer

Tools

18. Allen key (5mm)
19. Spark plug wrench

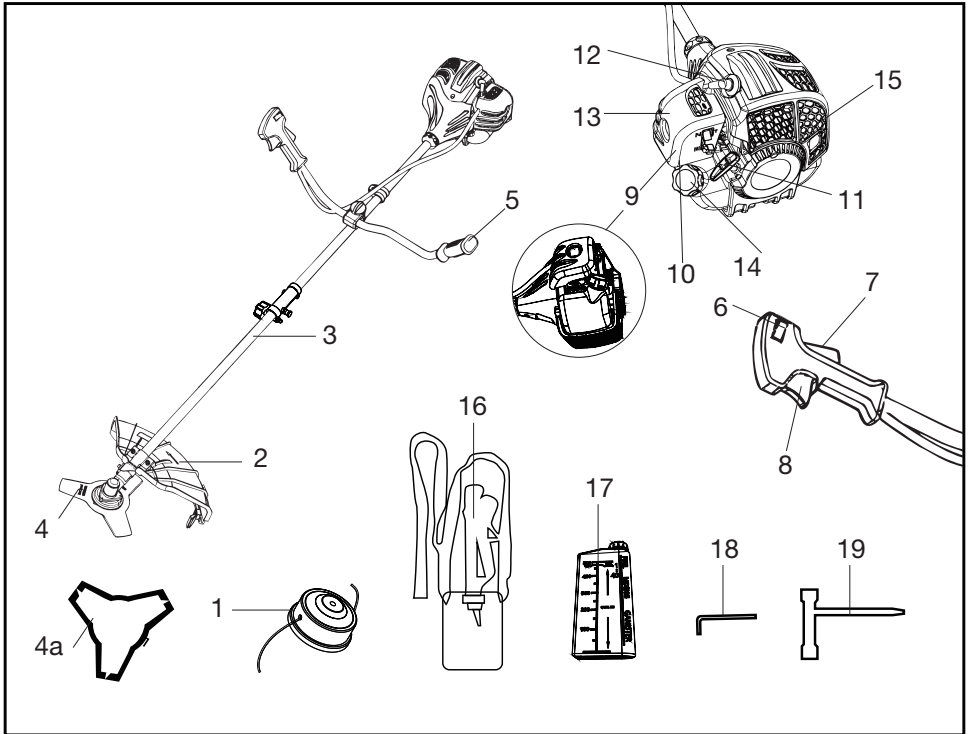

You will also need:

- 2-stroke oil - Unleaded fuel - Funnel

If there are any parts missing, please call the customer helpline on 01904 727 509.

Assembly



WARNING!

Take care when removing the packaging to prevent damage to the machine.

Make sure that you have sufficient space to put the machine down. Keep your feet apart so that you have a stable position; bend at the knees and keep your back straight.

Always recycle the packaging in accordance with local recycling schemes.

When assembling this machine, please follow these instructions.

Assemble the handle on the machine

1. Assemble the upper handle

Assemble the bike type handle on the machine:

- Release the inner hex screws,
- Take the right and left handle to the centre of the handle holder,
- Assemble the handle holder and tighten the inner screws.

ATTENTION! Make sure the spring is in position.

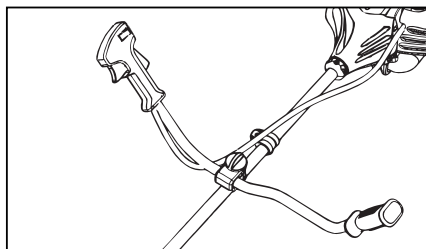
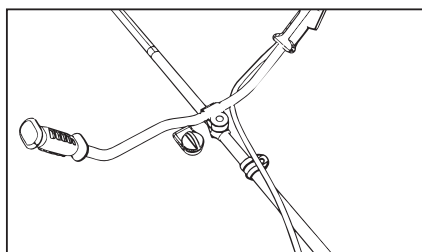
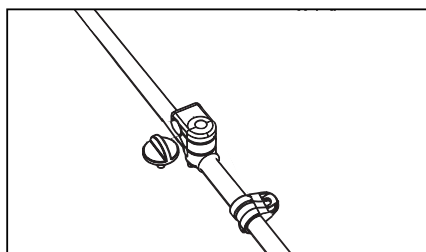

2. Remove the sleeve on the lower shaft

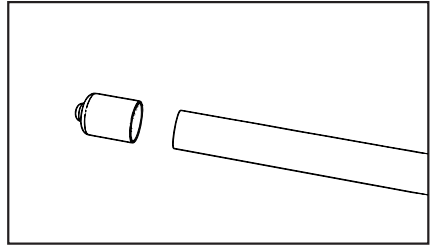
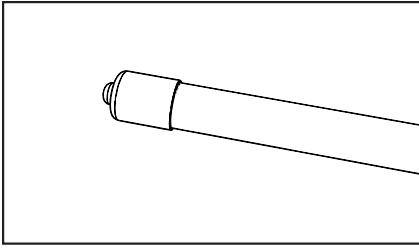

3. Assemble the lower shaft

Push the lower part of the shaft (b) right down until the stop pin (a) slots into the hole (c) in the shaft. This is easier to do if you rotate the bottom of the shaft (b) slightly in both directions. The pin (a) is in place when it is completely lodged in the hole. Lastly, tighten the knob (d) securely.

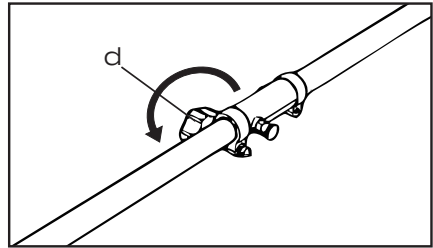
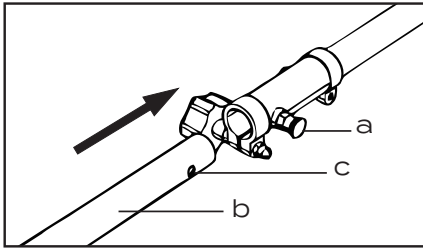

Assemble the safe guard

Fix the safety guard with the hex key and wrench (provided as standard accessories for tightening the nuts). Picture below.

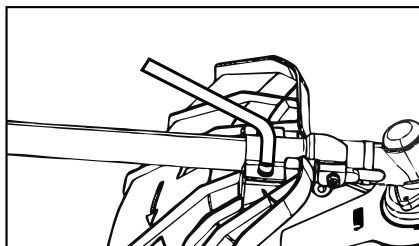
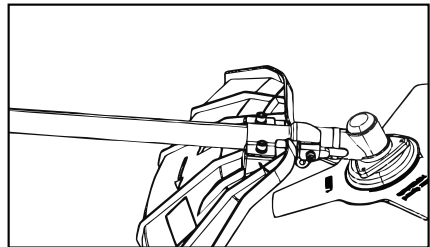
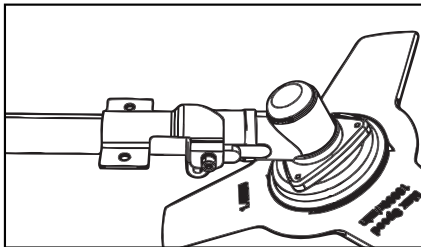



WARNING! Use only original manufacturer's replacement parts, accessories and attachments. Failure to do so can cause poor performance, possible injury and may void your warranty. Never use the machine without the guard assembled!

Assemble the Nylon cutting head

Release the nuts

Line up the two holes of the flange and shield. Using one screw driver to hold the flange, as shown below, turn the socket wrench clockwise until the nut is released.

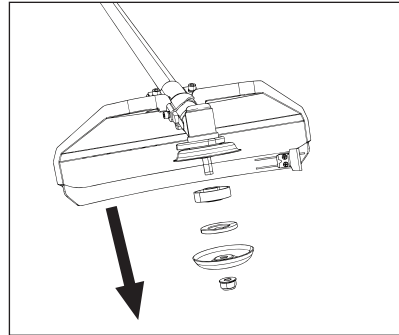
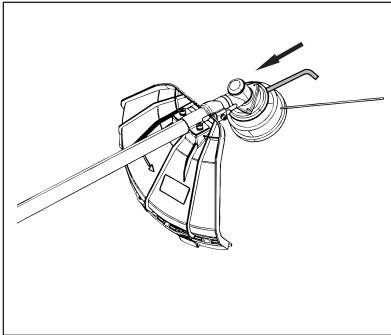

A. Assemble the nylon cutting head

Remove another shield after the nut is released. Still holding the flange, take the nylon cutting head on the shaft and rotate counter-clockwise. The nylon cutting head is fitted.

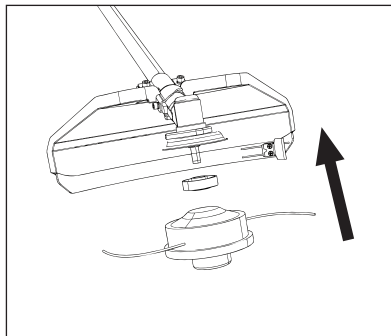

B. Assemble the blade

Take the outer flange off after releasing the nut, then put the blade, outer flange, shield and nut according to priority.

NOTE: The blade rotation direction needs to be the same as the picture below. Use the screwdriver to hold the flange and tighten the nut counter-clockwise, ensure the nut is tightened sufficiently.

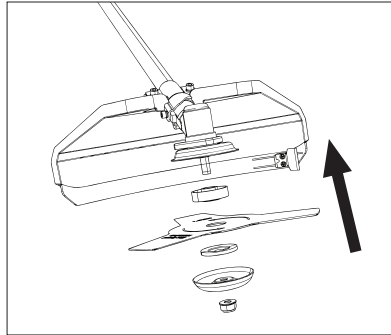

WARNING!

Make sure the cutting head has been assembled correctly before use!

Fit the strap

The brush cutter must be used with the harness provided.

1. Put the left and right straps over the shoulders and secure with the quick-connect function of the harness. The finished set up should resemble the picture below.

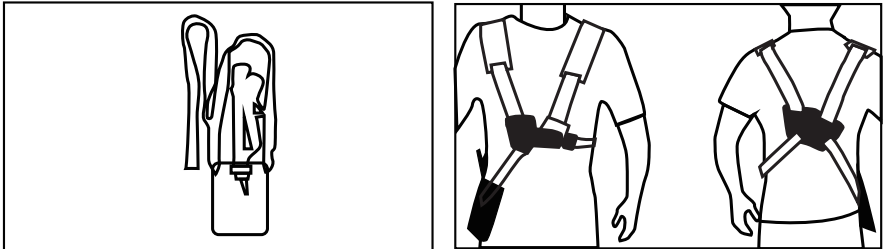

Note: At the front of the harness there is an easily accessible quick-release function. Use the quick release in any emergency situation that requires you to free yourself from the machine and harness.

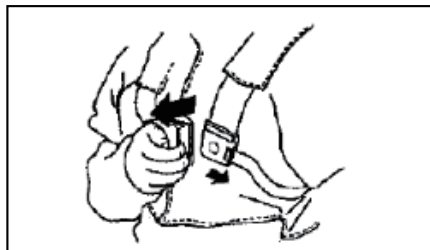

- Hook the double belt harness into the strap support ring on the shaft tube.

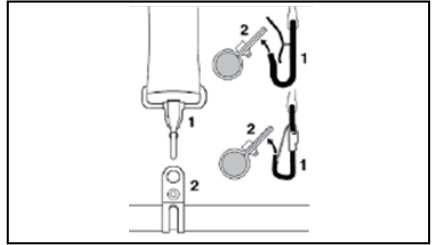
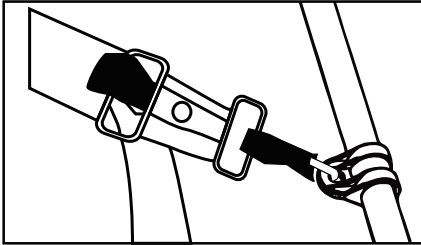
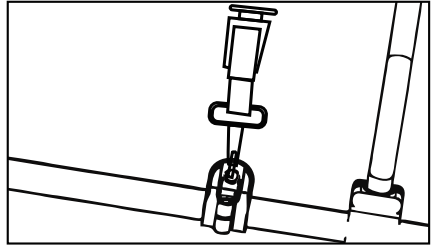
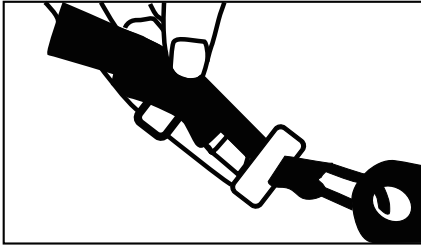

- Adjust the length until the spring hook is about a hand's width below your right hip.



NOTE: Let the cutting attachment rest lightly on the ground. If you use a grass blade, it should balance about 10cm above the ground to prevent contact with stones and the like. Adjust the position of the harness clamp to balance the unit correctly.

Preparation

Filling with engine fuel



WARNING! Always switch the engine off before fuelling. Never add fuel to a machine with a running or hot engine. Move at least 30ft. (9m) from the refuelling site before starting the engine. Do not smoke!



IMPORTANT! Keep the bottle flat while filling and use a suitable funnel.

This product is powered by a 2-stroke engine and requires pre-mixing of petrol and 2-stroke oil. Mix a high quality 2-stroke engine oil, according to JASO FC classic. Do not use automotive oil or 2-stroke outboard oil. DO NOT mix quantities larger than usable in a 30-day period.

Danger of injury! Fuel is explosive!

Turn off and cool the motor down before filling the tank with fuel. You must observe all safety instructions relating to handling fuel.

Risk of damage!

The machine is supplied without 2-stroke motor oil.

1a. Fuel mixture

1 litre (1000ml) petrol: 25cc (25ml) 2-stroke engine oil (40:1 ratio).

Using a funnel and keeping the bottle level, pour the fuel to the line marked PETROL; and pour engine oil to the line marked OIL. Shake vigorously to mix the two products prior to pouring into the tank of the brush cutter.

1b. Filling tank

Clean the surface around the fuel cap to prevent contamination. Loosen the fuel cap slowly, remove and rest the cap on a clean surface. Carefully pour fuel into the tank, avoiding spillage. Prior to replacing the fuel cap, clean and inspect the seal located inside the fuel cap. Immediately replace the fuel cap and hand tighten. Wipe up any fuel spillage.

NOTE: It is normal for smoke to be emitted from a new engine after first use.

Operation

When working with the machine, the appropriate plastic guard hood for 'cutting blade mode' or 'cutting line mode' must be fitted to prevent objects being thrown out.

The integrated blade in the cutting line guard hood automatically cuts the line to the optimum length.



ATTENTION! Before operating, you must fill the machine with fuel.

Starting the unit

Do not start the cutter until it has been completely assembled.

Danger of injury!

Do not operate the device unless you did not find any faults. If a part has become defective, be sure to replace it before you use the device again.

Check before use!

Check the safe condition of the machine.

Check the machine for leaks.

Check the machine for visual defects.

Check that all parts of the machine have been securely fitted.

Check that all safety devices are in proper condition.

Danger of injury!

Before starting work, always check the ground and remove all objects which could be thrown by the machine.

Start

Once the machine has been set up properly, start the engine as follows:

1. Set the machine down on a hard, level surface.
2. Turn the engine switch to the 'I' position.

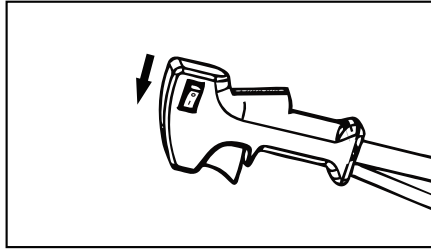

3. Put the choke lever in $|/\!$ position.

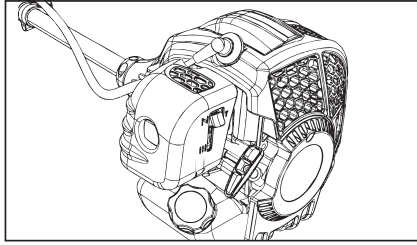

4. Press the fuel pump more than 5 times.

Note: If the engine is warm, move the choke lever to the $||\downarrow$ position, do not press the fuel pump.

5. Press and hold the machine then pull the recoil starter handle 5-6 times to start the engine.

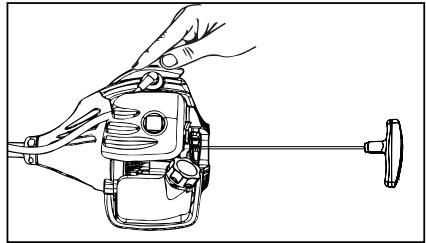
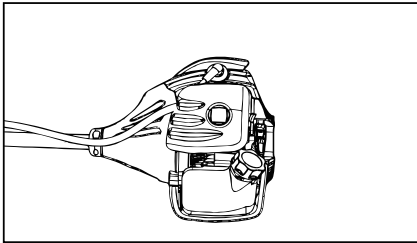

6. Wait a while then adjust the choke lever to $||\downarrow$ position.

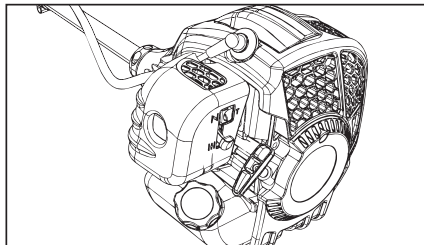

7. Pull the rope until the engine starts.
8. Run the machine for 30 seconds at idle speed, press the throttle lock (7), then hold throttle level (8).

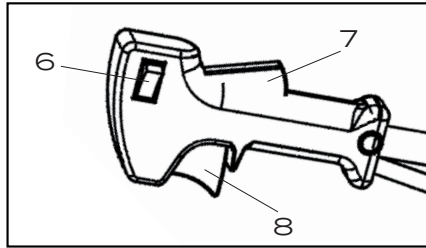

9. Adjusting line length while working:

This machine is fitted with a 'Tap & Go' head. To release more line, tap the cutting line head against the ground with the engine at top speed; the line will be released automatically and the knife will cut off the excess length.

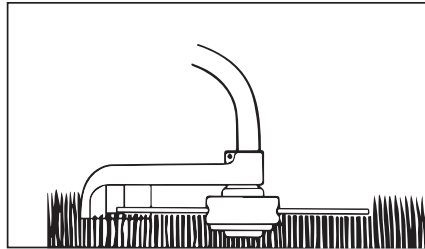

10. If you encounter any problems, turn the engine switch to the 'O' position to turn off the engine and the machine will stop.

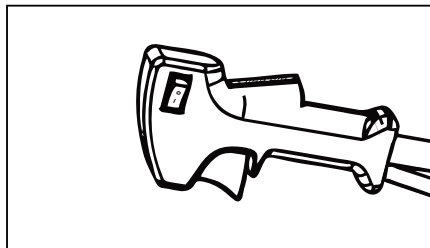

11. If any problem occurs, pull the pin of the safety strap, then release the brush cutter immediately.
12. If the machine is hot, the throttle level can be adjusted to the 'I' position directly when the machine is restarted.

NOTE: If the engine does not start up after several attempts, read the section '**Troubleshooting**'.

NOTE: Always pull the starter cord out in a straight line. If it is pulled out at an angle, then friction will occur on the eyelet. As a result of this friction, the cable will become frayed and will wear away faster. Always hold the starter handle when the cable retracts. Never allow the cable to snap back when it has been pulled out.

NOTE: Do not start the motor in tall grass.

ATTENTION: When the engine has been switched off, the cutter continues running for several seconds; therefore, do not touch the cutter head until it has come to a complete standstill.

Working instructions

Extending the cutting line



CAUTION! Do not use any kind of metal wire or metal wire encased in plastic in the line spool. This may cause serious injuries to the user. To extend the cutting line, run the engine at full speed and tap the line spool on the ground. This will automatically extend the line.

The blade on the safety shield will cut the line to the appropriate length.

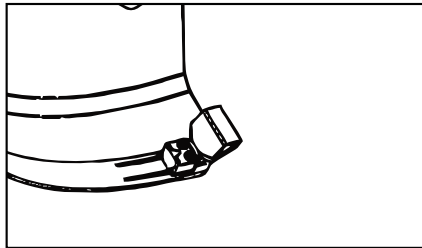

IMPORTANT: Remove all grass and weed remnants at regular intervals to prevent the shaft tube overheating. Lawn, grass and weed remnants become trapped under the safety shield and prevent the shaft tube from receiving adequate ventilation. Remove the remnants carefully using a tool. Do not use bare hands.

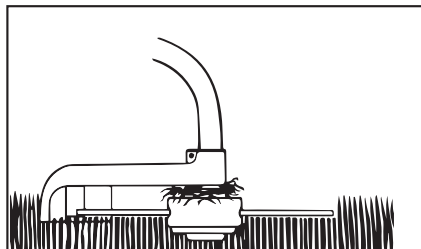

Different cutting methods

When the machine is correctly assembled it will cut weeds and long grass in places which are difficult to access, e.g. along fences, walls and foundations, and trees. It can also be used for 'mowing' down vegetation to prepare a garden for other applications.

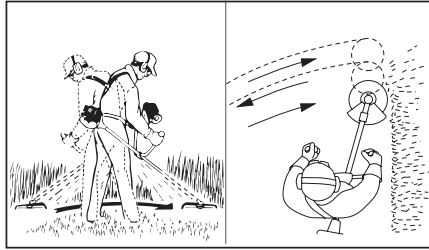

ATTENTION: Even if it is used carefully, cutting around foundations, stone or concrete walls will result in the line suffering more than normal wear.

Trimming/mowing

Swing the trimmer from side to side in a scything motion. Always keep the line spool parallel to the ground. Check the site and decide which cutting height you require. Guide and hold the line spool at the required height to obtain an even cut.

Low trimming

Hold the trimmer right in front of you at a slight angle so that the underside of the line spool is above the ground and the line strikes the correct target. Always cut away from yourself.

Never draw the trimmer towards yourself.

Cutting along fences/foundations

Approach wire mesh fences, lath fences, natural stone walls and foundations slowly so that you can cut close to them without striking the obstacle with the line. If, for example, the line strikes stones, stone walls or foundations, it will wear or fray. If the line strikes wire fencing, it will break.

Trimming around trees

When trimming around tree trunks, approach slowly so that the line does not strike the bark. Walk around the tree, cutting from left to right. Approach grass or weeds with the tip of the line and tilt the line spool forwards slightly.



WARNING! Take extreme care during mowing work. When doing such work, keep a distance of 30 metres between yourself and other people or animals.

Mowing

When mowing, you want to cut all the vegetation down to the ground. To do this, set the line spool at an angle of 30° to the right. Place the handle in the required position.

Remember the increased risk of injury to the user, bystanders and animals, and the danger of damaging property due to objects (for example stones) being thrown.



WARNING! Do not use the machine to remove objects from footpaths, etc. The machine is a powerful tool and can throw small stones and other objects a distance of 15 metres or more, causing injuries and damage to cars, houses and windows.

Jamming

If the cutting blade jams as a result of attempting to cut vegetation that is too dense, switch off the engine immediately. Remove the grass and scrub from the machine before you restart it.

Preventing recoil

When you work with the blade, there is a risk of recoil if it strikes solid objects, such as tree trunks, branches, tree stumps or stones. This will throw the cutter backwards in the direction opposite to the rotation of the tool. This can cause you to lose control of the cutter. Do not use the blade near fences, metal posts, boundary stones or foundations.

Maintenance and Storage



INJURY WARNING: Always wear protective gloves when working on or around cutting equipment.

When not in use, in transit or storage, always install transport protection on all cutting machine.

Before performing any maintenance or cleaning work, always turn off the engine and pull out the spark plug boot.

1. Do not spray the unit with water. It damages the engine.
2. Clean the unit with a cloth or hand brush, etc.

Maintenance schedule

	12 hours of use	24 hours of use	36 hours of use
Air filter	clean	clean	replace
Spark plug	check	clean	replace

Expert examination required:

- When the brush cutter hits an object.
- When the engine suddenly stops.
- If the blade is bent (do not straighten yourself!)
- If the gearbox is damaged.

Regular checks

Keep in mind that the following specifications relate to normal usage. Owing to circumstances (longer periods of daily work, severe dust exposure, etc.), the specified intervals will become correspondingly shorter.

Before the start of work and after refuelling:

Check if cutting tools are positioned securely, examine the product for any signs of damage or deterioration, and sharpen the cutting blade.

Weekly inspection:

Lubrication of gear.

If necessary:

Retighten accessible fastening screws and nuts. You will avoid excessive wear and tear and damage to the machine when you follow the instructions in this manual.

Replacing the line spool/cutting line

1. Dismantle the line spool as described in the 'Assembly' section. Press the spool together and remove one half of the housing.

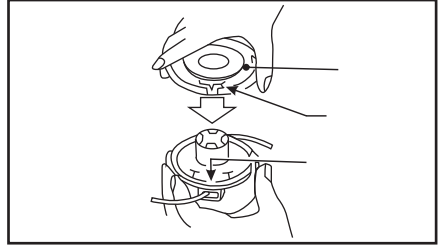
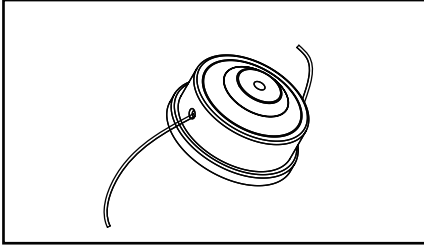

2. Take the spool plate out of the line spool housing.

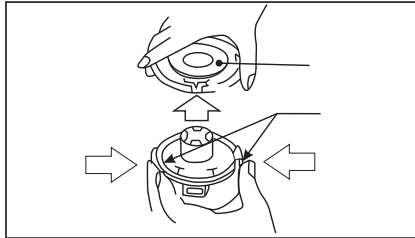

3. Remove any remaining cutting line.
4. Place the new cutting line in the centre and hang the loop which has formed into the recess in the spool splitter.

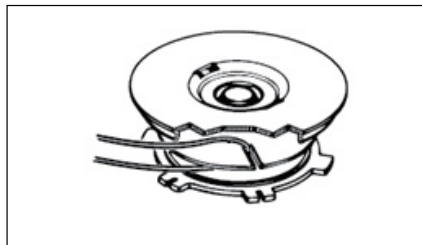

- Under tension, wind the line onto the spool counter clockwise. The spool splitter will separate the two halves of the line.

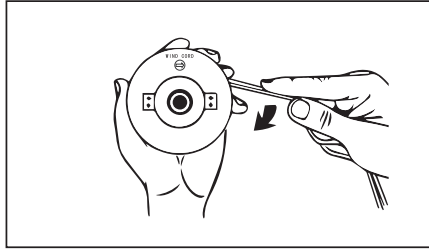

- Hook the last 15cm of the two ends of the line onto the opposite lying line holders of the spool plate.

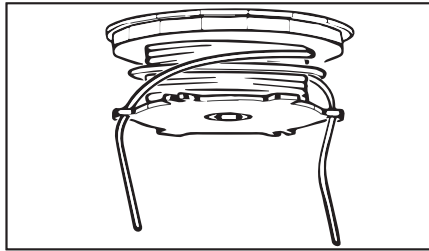

- Thread the two ends of the line through the metal eyelets in the line spool housing.
- Press the spool plate into the line spool housing.
- Pull the two line ends sharply to release them from the line holders.
- Join the housing parts together again.
- Cut the excess line to a length of around 13cm. This will reduce the load on the engine when starting and warming up.
- Remount the line spool. If you are replacing the complete line spool, skip '**Assembly**'.

Sharpening the safety hood blade

The safety hood blade can become blunt over time. When you notice this, undo the screw holding the safety hood blade on the safety hood.

Clamp the blade in a vice.

Sharpen the blade with a flat file and make sure that the angle of the cutting edge is not altered in the process. File in one direction only.

The safety hood blade will become blunt over time, we therefore recommend replacing the blade with a new one or re-sharpening it at the end of every season.

To re-sharpen the blade, clamp the safety hood blade securely in a vice or clamp and undo the screw which holds the blade. A flat file should be used when re-sharpening the blade, ensuring you don't alter the angle, and file in one direction only.

An unbalanced blade will cause the brush cutter to vibrate violently and may result in an accident or injury to the operator.

Change and clean the spark plug

1. Once the engine has cooled, remove the spark plug using the socket spanner supplied.

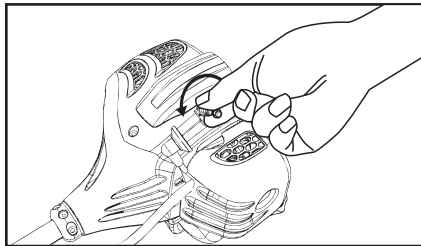
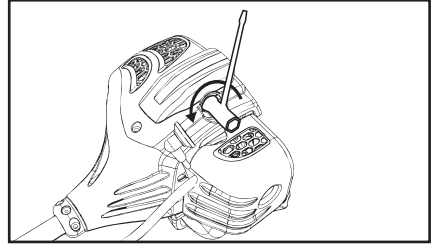
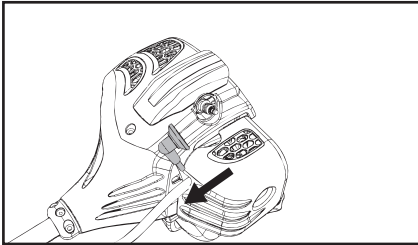

2. Clean the plug with a wire brush.
3. Using a feeler gauge, set the gap to 0.5-0.7mm.
4. Install the spark plug carefully by hand to avoid cross-threading.

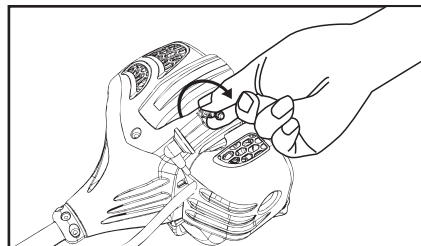

5. After the spark plug is seated, tighten with a spanner to compress the washer.

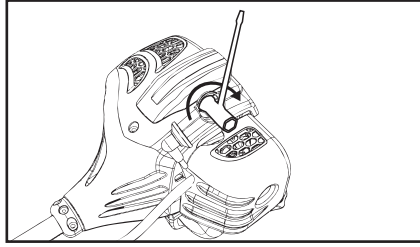

Change and clean the air filter

Soiled air filters reduce the engine power by supplying too little air to the carburettor.

Regular checks are therefore essential.

1. Unclip the air filter cover and remove the sponge filter element.
2. To avoid objects falling into the air tank, replace the air filter cover.
3. Wash the filter element in warm soapy water, rinse and allow to dry naturally.

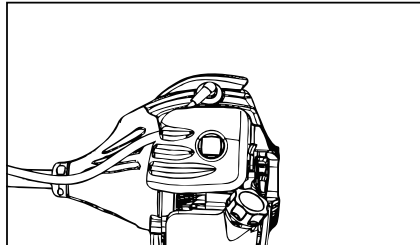
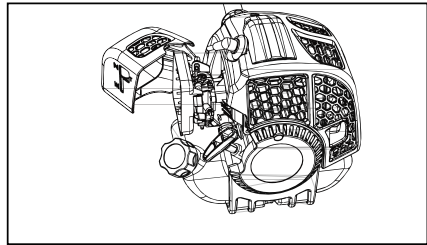
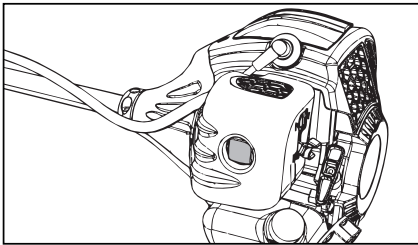

IMPORTANT: Never clean the air filter with petrol or flammable solvents.

WARNING! Never run the engine without the air filter element installed.

Lubricate angle transmission

Lubricate with lithium-based grease. Remove the screw and put in the grease, turning the shaft manually until grease emerges, then replace the screw.

Storing the unit

After cutting, clean the unit thoroughly. Store the unit in a dry room, allowing the motor to cool down beforehand.

Transport

Due to safety reasons, please see to it that the cutter is transported free of oil and gas!

Worn parts

Even when used in the intended way, some components are subject to normal wear. They will have to be replaced depending on the duration of usage. These parts include, among others, the cutting tool and the retaining disk.



WARNING! Use only the original manufacturer's replacement parts, accessories and attachments. Failure to do so can cause poor performance, possible injury and may invalidate your warranty.

Replacement parts/accessories:

For the cutting listed here, you can always use the safety guards provided with the unit.

Machine/brush cutter:

Spool with Ø 420	O184201086
Blade with 3 teeth Ø 255 x 1.4	O184201087
Safety shield for machine	O184201081

Storing the cutter

If you intend to store the cutter for longer than 30 days, it must be prepared accordingly; otherwise, the fuel still remaining in the carburettor will evaporate and leave a rubbery sediment. This can cause problems when starting up the machine and may require expensive repairs.

Slowly remove the fuel tank cap to release any pressure that may have formed in the tank. Carefully empty the tank.

To remove the fuel from the carburettor, start the engine and let it run until the cutter stops.

Leave the engine to cool (approx. 5 minutes).

Remove the spark plug (see section **Change and clean the spark plug**).

Add one teaspoon of 2-stroke engine oil into the combustion chamber. Slowly pull the starter cord several times to apply a layer of oil to all internal components. Fit the spark plug again.

NOTE: Store the cutter in a dry place and far away from possible ignition sources.

Putting the cutter back into operation

Remove the spark plug (see section **Change and clean the spark plug**).

Quickly tug on the starter cord to remove excess oil from the combustion chamber.

Clean the spark plug and check that the electrode gap is correct, or insert a new spark plug with the correct electrode gap.

Prepare the equipment for operation.

Fill the tank with the relevant mixture of fuel and oil (see the section **Fuel and oil mixture**).

Transport

To transport the machine, first empty the petrol tank.

Clean coarse dirt off the cutter with a brush or hand brush.

Always assemble the transport protection to all cutting tools.

To prevent damage and injuries, the cutter must be secured against tipping over and slipping during transport in vehicles.

Troubleshooting

The table below contains a list of fault symptoms and explains what you can do to remedy the problem if your cutter fails to work properly. If the problem persists after working through the list, please contact your nearest service workshop.

Fault	Possible Cause	Solution
The cutter does not start	<ol style="list-style-type: none"> 1. Correct starting procedure not followed 2. Sooted or damp spark plug 3. Incorrect carburettor setting 4. Blade or Nylon cutter mounted incorrectly 5. No fuel in the tank 	<ol style="list-style-type: none"> 1. Follow the instructions for starting 2. Clean the spark plug or replace it with a new one 3. Contact an authorised customer service outlet 4. Reassemble the blade or Nylon cutter 5. Check the fuel level
The cutter starts but does not develop its full power	<ol style="list-style-type: none"> 1. Incorrect choke lever setting 2. Soiled air filter 3. Incorrect carburettor setting 4. Blunt cutting blade 	<ol style="list-style-type: none"> 1. Set the choke lever on the  position 2. Clean the air filter 3. Contact an authorised customer service outlet 4. Have cutting blade re-sharpened/ replaced
The engine does not run smoothly	<ol style="list-style-type: none"> 1. Incorrect electrode gap on the spark plug 2. Incorrect carburettor setting 	<ol style="list-style-type: none"> 1. Clean the spark plug and adjust the electrode gap, or fit a new spark plug 2. Contact an authorised customer service outlet
Engine smokes excessively	<ol style="list-style-type: none"> 1. Incorrect fuel mix 2. Incorrect carburettor setting 	<ol style="list-style-type: none"> 1. Use the correct fuel mix (see fuel mixing table) 2. Contact an authorised customer service outlet
If the temperature of machine is too high	Engine is overloaded	Ensure the machine has a rest period

Technical Data

Property	Value
Model no.	RG415
Engine type	Single-cylinder, 2-stroke
Displacement (cc)	42.7cm ³
Engine power	1.25kW
Tank capacity	1200ml
Idle speed	3100min ⁻¹
Clutch engaged speed	4500min ⁻¹
Ignition	C.D.I
Cutting width - grass trimmer	420mm
Cutting width - brush cutter	255mm
Diameter of cutting line	Ø2.4mm
Net weight	7.5kg
Sound pressure level L _{PA} (dB)	99 dB(A) K=3 dB(A)
Sound power level L _{WA} (dB)	114 dB(A) K=3 dB(A)
Guaranteed sound power level L _{WA} (dB)	114 dB(A)
Vibration (m/s ²)	8.3m/s ² K=1.5m/s ²
Spark type	L8RTF
Maximum engine power in accordance with ISO8893	1.25KW
Maximum rotational frequency of the spindle	6800 (brush cutter)min ⁻¹ 6000 (grass trimmer)min ⁻¹

Disposal

The cutter is supplied in packaging to prevent it from being damaged in transit.

The raw materials in this packaging can be reused or recycled. The cutter and its accessories are made of various types of material, such as metal and plastic. Defective components must be disposed of as special waste. Ask your dealer or your local council.

Getting Help

Our dedicated UK-based customer helpline is open 7 days a week to assist you with assembly, parts queries and technical support. We are open during office hours but you can always send an email via **support@coreservice.co.uk**. Our experts are here to get you back enjoying your garden in no time.

For useful assembly, starting and maintenance videos, and for ordering spares, please visit **www.coreservice.co.uk**.

Using our service does not affect your statutory rights.

Warranty

This product is covered by a 2 year warranty.

The warranty covers any manufacturing defect in materials, workmanship, and finish.

Any claim under this warranty must be made by going to your nearest Homebase store, taking your proof of purchase with you. Claims must be made within 2 years of the date of purchase.

We will offer you a free repair of the item where this is possible, or a replacement or a refund. Your statutory rights remain unaffected, in particular, any rights you may have under the Consumer Rights Act 2015.

This warranty is given by HHGL Limited, MK9 1BA; HHGL (ROI) Limited, DO2 X576.

PLEASE NOTE: This warranty does not apply to products misused or neglected, and only covers domestic use. It does not apply to commercial use of the product.