



HOMEBASE

GIANT WALK-IN GREENHOUSE

INSTRUCTION MANUAL

IMPORTANT: Please read these instructions before using the product and retain for future use.

HHGL Limited, MK9 1BA
HHGL (ROI) Limited, D02 X576

ASSEMBLY INSTRUCTIONS

BEFORE YOU BEGIN

Read through the entire instructions before assembling.

Please check that you have all of the parts before starting assembly.

Assembly of the greenhouse is easier with two people.

Assemble the greenhouse on a dry, level surface.

The best way to connect rods with connectors is to twist them in, all the way. Ensure that they are fully pushed in.















If using a rubber mallet to help with assembly, be sure not to damage parts by using excessive force.

Handle parts with care.

Once the frame has been assembled, all four corners should be pegged down to ensure the stability of the unit.

The greenhouse should be installed in an area protected against high winds and wind-driven rain.

PARTS LIST

PART REF.	DESCRIPTION	DIAGRAM	QTY.	PART REF.	DESCRIPTION	DIAGRAM	QTY.
A	3-outlet connectors		x 4	①	Rods		x 2
B	T-piece connectors		x 2	②	Rods		x 2
C	Screws M6x35		x 9	③	Rods		x 4
D	Nuts M6		x 9	④	Rods		x 6
E	Pegs		x 12	⑤	Rods		x 3
F	Ropes		x 4	⑥	Rods		x 3
G	PE cover		x 1	⑦	Support roof rods		x 6
				⑧	Support roof rods		x 3

1

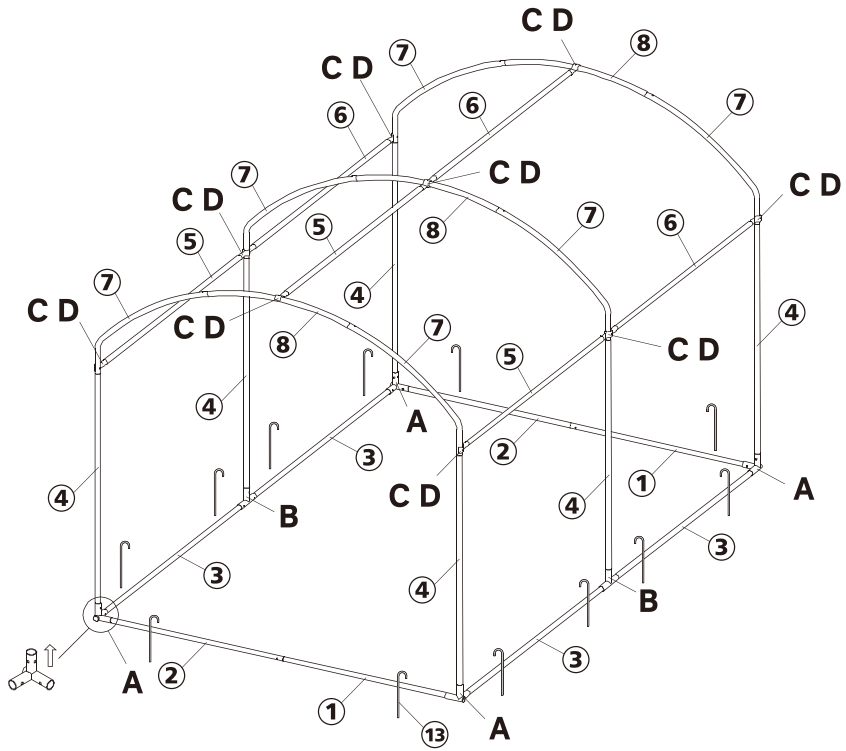

2

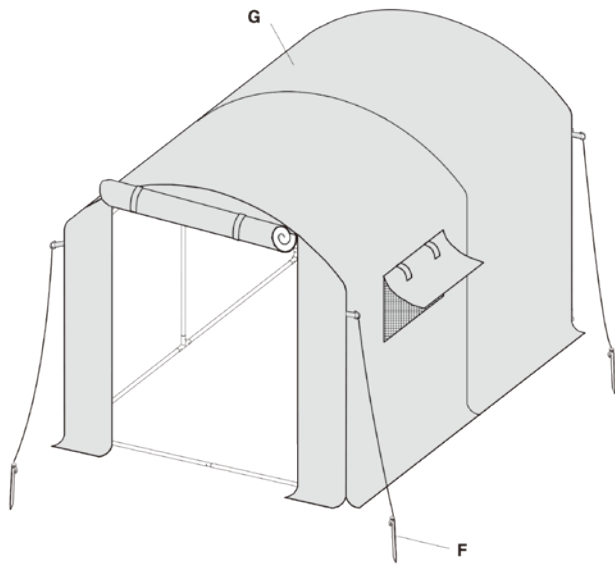

3



Your greenhouse is now ready for use.