



# COUNTRY LIVING

with **HOMEBASE**

**CL Farmhouse 1 Light Enamel Pendant 46cm**

**600878**

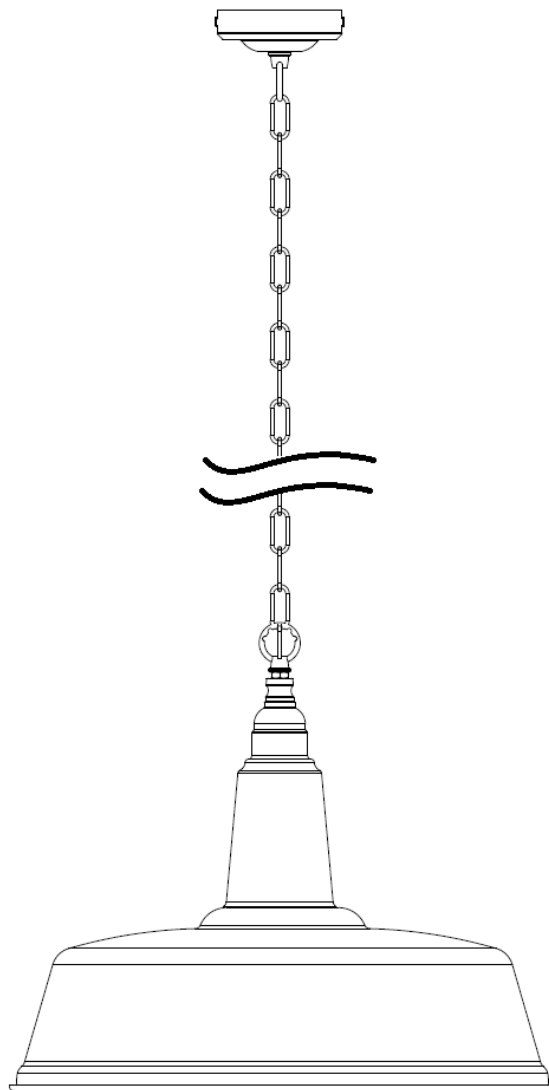

## **Instruction Manual**

**IMPORTANT:** Please read these instructions before using the product and retain for future use  
HHGL Limited, MK9 1BA; HHGL (ROI) Limited, D02 X576

## Safety and care advice

- For your safety, this product must be installed in accordance with local building regulations. If in any doubt, or where required by law, consult a competent person who is registered with an electrical self-certification scheme. Further information is available online or from your local authority.
- This product has been designed for non-professional, domestic use only.
- Dispose of all packaging correctly and responsibly and in accordance with all local laws and regulations. Never leave packaging components within reach of children as they can be a source of danger.
- Before inserting or replacing bulb (s) ensure the power is switched off and the bulb (s) have cooled down.
- Do not modify or alter any product before or after installation. This may render the product un-safe.
- This is a Class 2 product and does not require an earth connection.
- This fitting must be permanently wired into the electricity supply.
- Always shut off the power to the circuit before starting installation.

## Warnings

- This product is not intended for use by persons (including children) with reduced physical, sensory and mental capabilities, or lack of experience and knowledge, unless they have been given supervision or instruction concerning use of the product by persons responsible for their safety.
- Children should be supervised to ensure that they do not play with the product.
- **Do not** place this fitting in a damp atmosphere.

## Care and maintenance

- Always disconnect power supply when servicing or cleaning.
- Use a clean dry soft or slightly damp cloth for cleaning this product.
- Do not use abrasive cloths or polishes as this may cause damage to the product.

## Changing the bulbs

- Ensure that the bulb has cooled down before replacing.
- Ensure that the power supply has been disconnected.

### IMPORTANT!

- If the external flexible cable or cord of this luminaire is damaged it shall be exclusively replaced by the manufacturer or his service agent or similar qualified person.

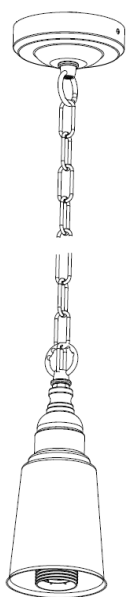

Pre-wired fitting x 1

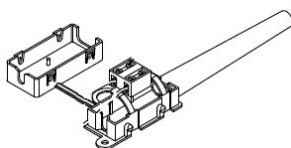

Terminal block x 1  
Pre-fitted on the ceiling can

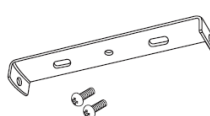

Fixing bracket x 1  
Pre-fitted on the ceiling can



Fixing screws x 2

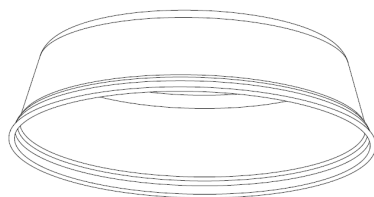

Enamel Shade x 1



Shade Ring x 1



Ceiling Plugs x 2

# Assembly

## STEP 1

- A. Remove the fixing bracket from the ceiling plate. Using the fixing bracket as a template, drill suitable holes into a ceiling joist (taking care not to damage any internal wiring or pipes).
- B. Fit the ceiling plugs ( NOT SUPPLIED) securely into the previously drilled holes and secure the fixing bracket in place with the fixing screws.
- C. Connect the supply wires to the terminal block, opposite the corresponding wires from the fitting see FIG 1.(Ensure that connections are tight and no loose strands of wire are left out of the connector block). Wrap 2 layers of suitable insulation tape around the terminal block (NOT SUPPLIED).
- D. Place the ceiling can over the pre-fixed bracket and secure in place using the side screw.

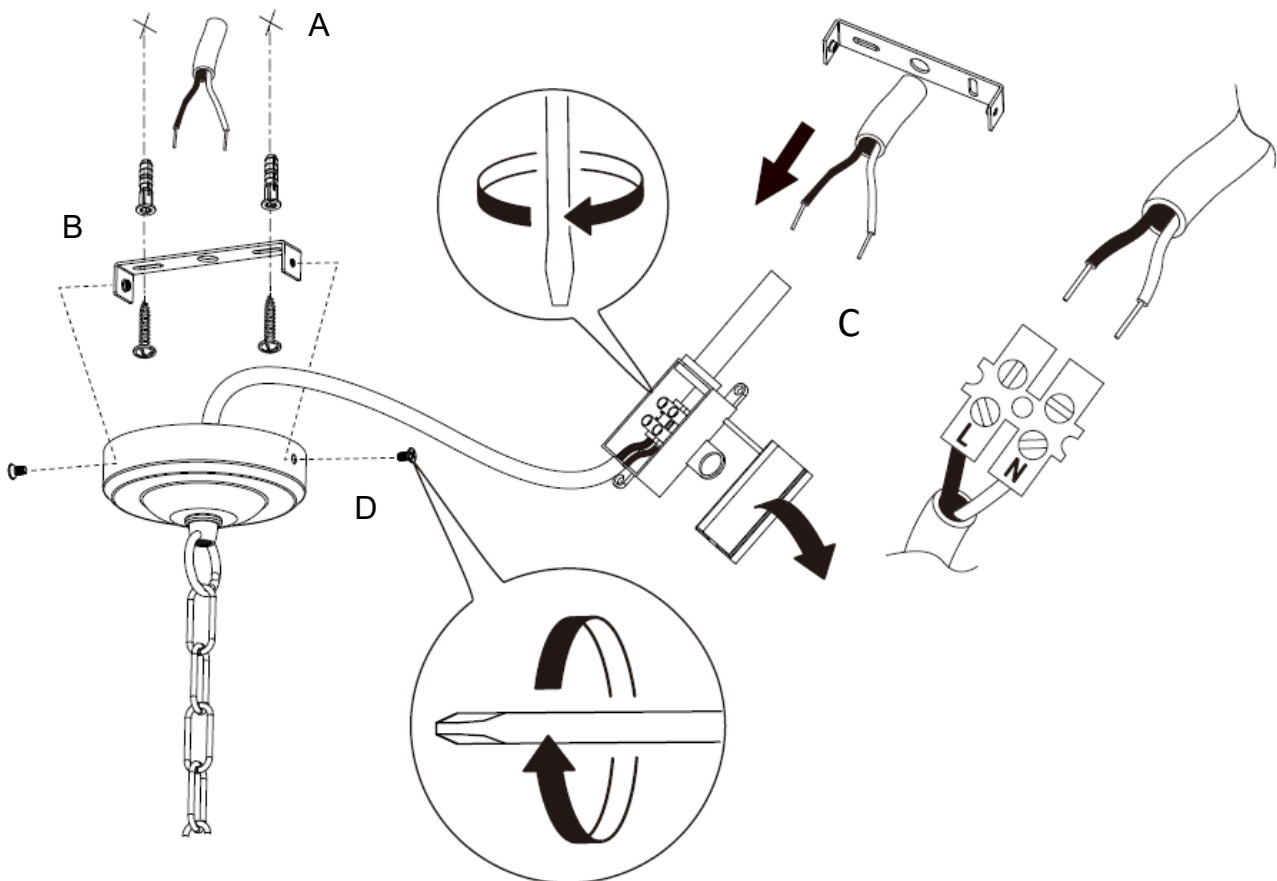

### MAINS SUPPLY

### LIGHT FITTING

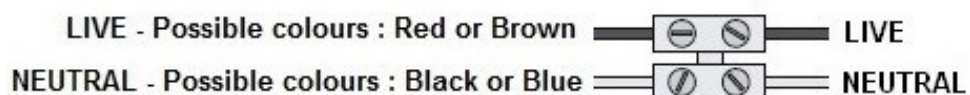

STEP 2

A. Place the shade onto the lamp holder

B. Screw shade ring onto the lamp holder to secure shade in place

C. Screw the bulb (not supplied) into the lamp holder.

Turn on the mains power supply and test the fitting.

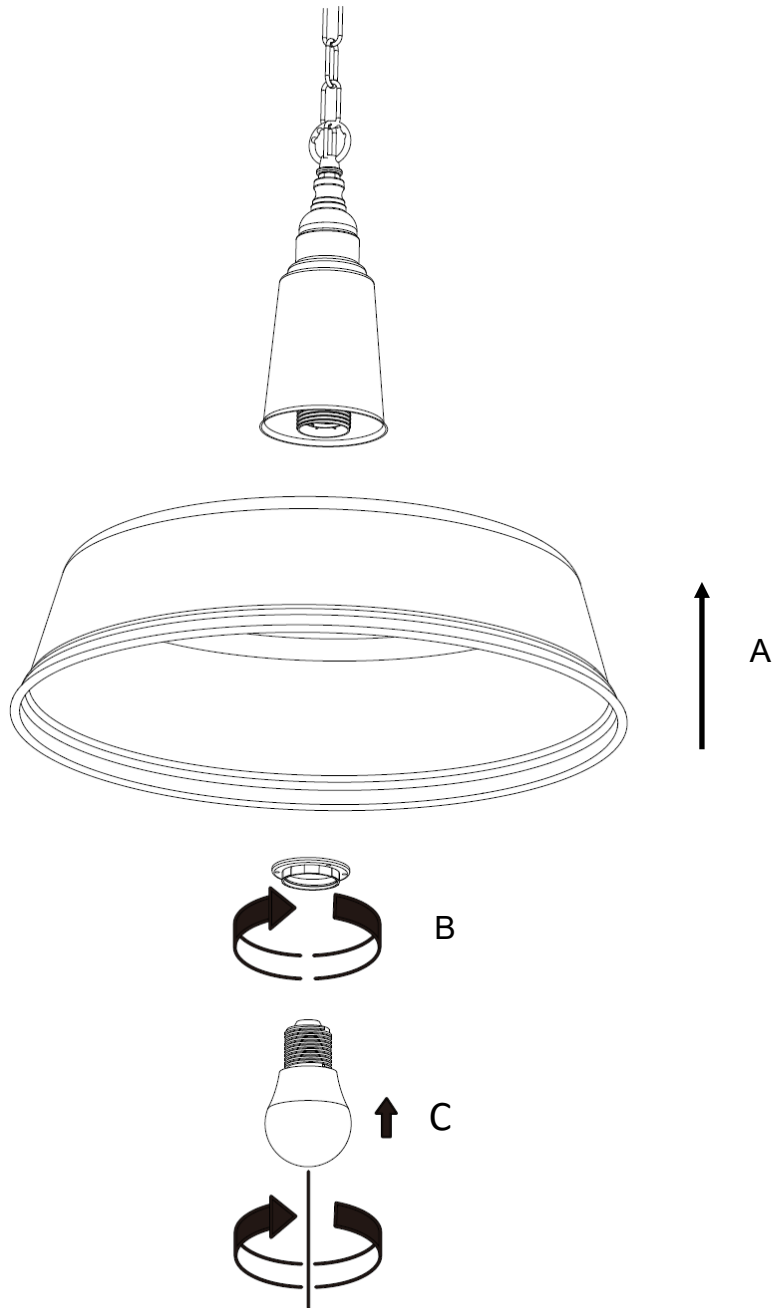

We recommend LED bulbs only

Maximum wattage - See Lamp holder

Light bulb shape - See Lamp holder