





FLOATING PHOTO SHELF

MAX 5KG*
 PLASTERBOARD

MAX 10KG*
 MASONRY

*LOAD EVENLY DISTRIBUTED

- Parts List**
-  **A x2pcs**
 -  **B x2pcs**
 -  **C x2pcs**
 -  **D x2pcs**

Step 1

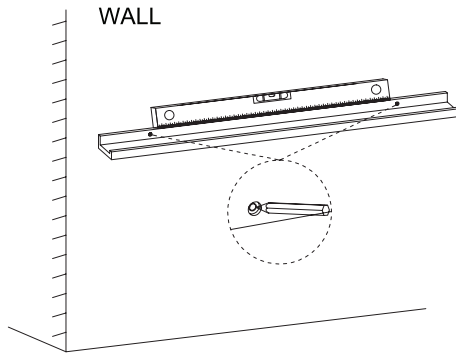

Step 2

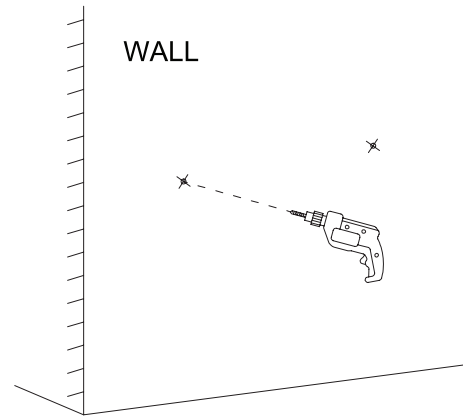

Step 3

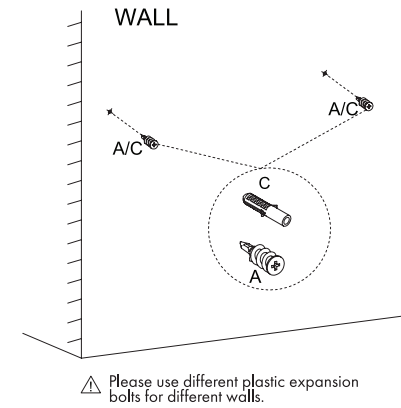

Step 4

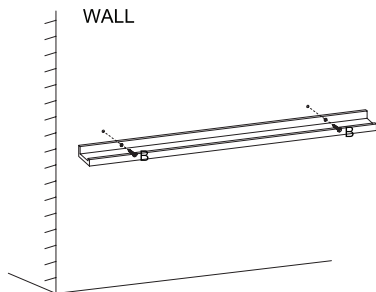

Step 5

