

# ozito

## ORBITAL SANDER

**1/4 SHEET**

### ORIGINAL INSTRUCTIONS

#### SPECIFICATIONS

Voltage:	230-240V ~ 50Hz
Power:	135W
No Load Speed:	13,000/min
Pad Shape:	1/4 Sheet
Pad Size:	(110x100mm)
Weight:	0.9kg

[ozito-diy.co.uk](http://ozito-diy.co.uk)

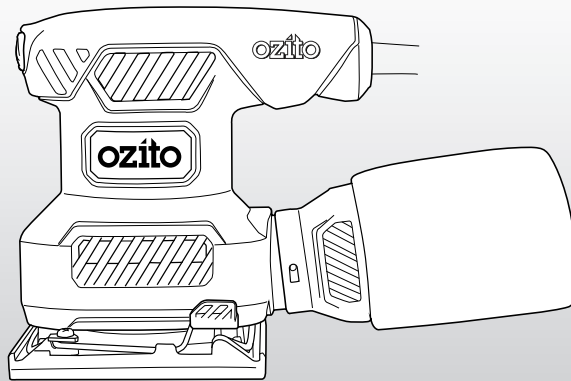

#### WHAT'S IN THE BOX

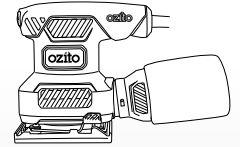

Quarter Sheet Sander

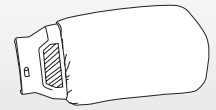

Dust Bag

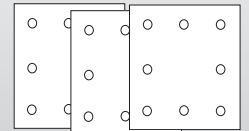

Sand Paper x 3

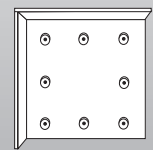

Paper Punch Plate

# 3 YEAR REPLACEMENT WARRANTY

QSS-1000U

## WARRANTY

All of our products undergo strict quality checks to ensure that they reach you in perfect condition. In the unlikely event that your device develops a fault, please contact our service department at the address shown on this guarantee card. You can also contact us by telephone using the customer service number shown. Please note the following terms under which guarantee claims can be made:

1. These warranty terms regulate additional warranty services, which the manufacturer mentioned below promises to buyers of its new products in addition to their statutory guarantee claims are not affected by this guarantee. Our guarantee is free of charge to you.
2. The warranty services only covers defects due to material or manufacturing faults on a product which you have bought from the manufacturer mentioned below are limited to either the rectification of said defects on the product or the replacement of the product, whichever we prefer.  
Please note that our devices are not designed for use in commercial, trade or professional applications. A guarantee contract will not be created if the device has been used by commercial, trade or industrial business or has been exposed to similar stresses during the guarantee period.
3. The following are not covered by our guarantee:
  - Damage to the device caused by a failure to follow the assembly instructions or due to incorrect installation, a failure to follow the operating instructions (for example connecting it to an incorrect mains voltage or current type) or a failure to follow the maintenance and safety instructions or by exposing the device to abnormal environmental conditions or by lack of care and maintenance.
  - Damage to the device caused by abuse or incorrect use (for example overloading the device or the use of unapproved tools or accessories), ingress of foreign bodies into the device (such as sand, stones or dust, transport damage), the use of force or damage caused by external forces (for example by dropping it).

- Damage to the device or parts of the device caused by normal or natural wear or tear or by normal use of the device.

4. Your Product is guaranteed for a period of 36 months from the original date of purchase and is intended for DIY (Do It Yourself) use only. Lithium Ion batteries and chargers are covered by a 12 month warranty. Warranty excludes consumable parts. Guarantee claims should be submitted before the end of the guarantee period within two weeks of the defect being noticed. No guarantee claims will be accepted after the end of the guarantee period. The original guarantee period remains applicable to the device even if repairs are carried out or parts are replaced. In such cases, the work performed or parts fitted will not result in an extension of the guarantee period, and no new guarantee will become active for the work performed or parts fitted. This also applies if an on-site service is used.

IN ORDER TO MAKE A CLAIM UNDER THIS WARRANTY YOU MUST RETURN THE PRODUCT TO THE PLACE OF PURCHASE WITH YOUR REGISTER RECEIPT.

Please refer to the restrictions of this warranty concerning wearing parts, consumables and missing parts as set out in the service information in these operating instructions.

CUSTOMER SERVICE HELPLINE  
GB: 0151 294 4488  
IRL: 1850 882711  
[Ozito-diy.co.uk](http://Ozito-diy.co.uk)

# KNOW YOUR PRODUCT

## QUARTER SHEET SANDER

- |                           |                    |
|---------------------------|--------------------|
| 1 On/Off Switch           | 3 Sure Grip Handle |
| 2 Hook & Loop Backing Pad | 4 Spring Clamp     |

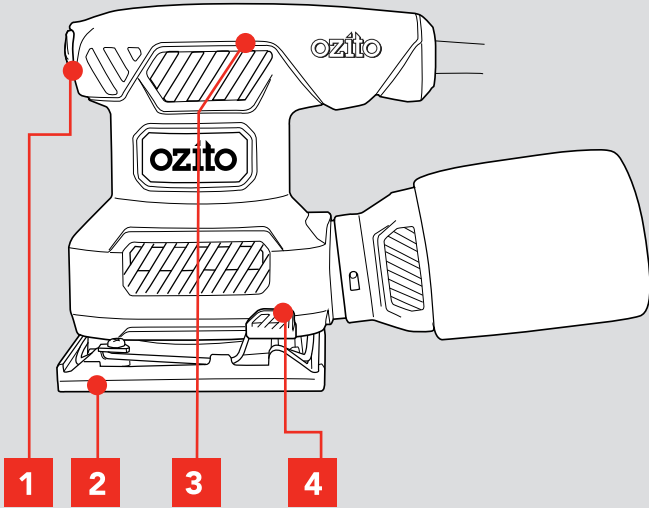

## ACCESSORIES

- |                              |                      |
|------------------------------|----------------------|
| 5. Dust Bag                  | 7. Paper Punch Plate |
| 6. Hook & Loop Sanding Sheet |                      |

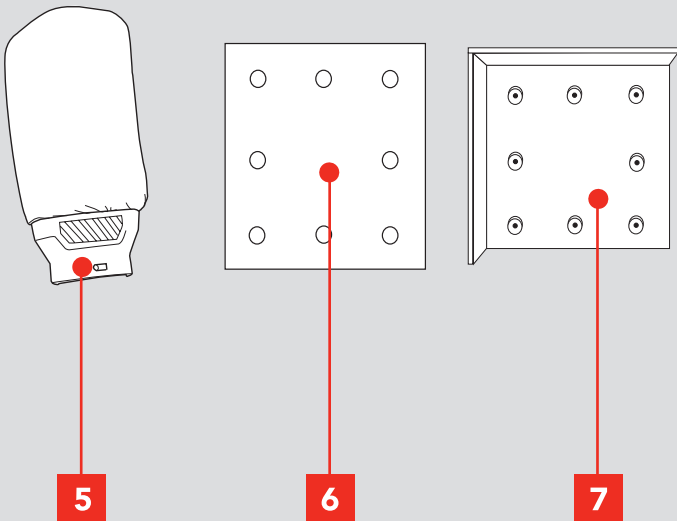

## ONLINE MANUAL

Scan this QR Code with your mobile device to take you to the online manual.



# SETUP & PREPARATION

## 1. SANDING SHEET FITMENT

Ensure the tool is disconnected from the power supply before performing any of the following operations.

The holes on the bottom of the sanding pad allow the dust bag to draw the sanding dust away from the work area.

1. When fitting the sanding sheet, align the holes on the sheet with the holes on the sanding pad.

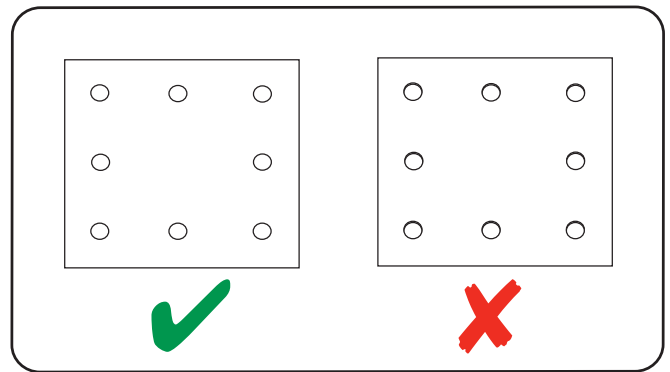

2. Unlock the spring clamp on both sides of the sander.

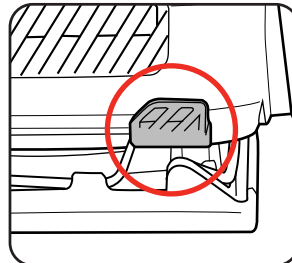

3. Fold the sandpaper to match the contours of the sanding pad.

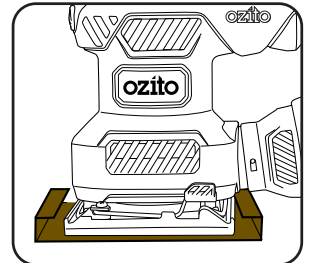

4. Feed the paper under the clamp at the front of the sander. Lock the clamp.

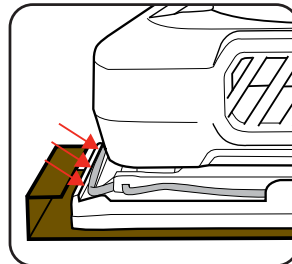

5. Feed the paper under the clamp at the rear of the sander. Lock the clamp.

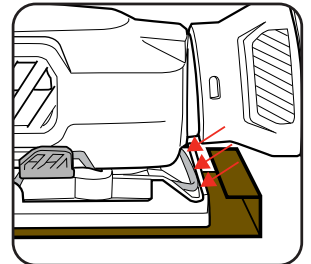

**Note:** Ensure the sanding sheet is firmly clamped and held flat against the base of the sanding pad.

# 3 YEAR REPLACEMENT WARRANTY

## 2. PAPER PUNCH PLATE

Use the punch to create dust extraction holes on the sandpaper which align with the holes on the sander.

1. Fit the 1/4 sanding sheet to the sander.

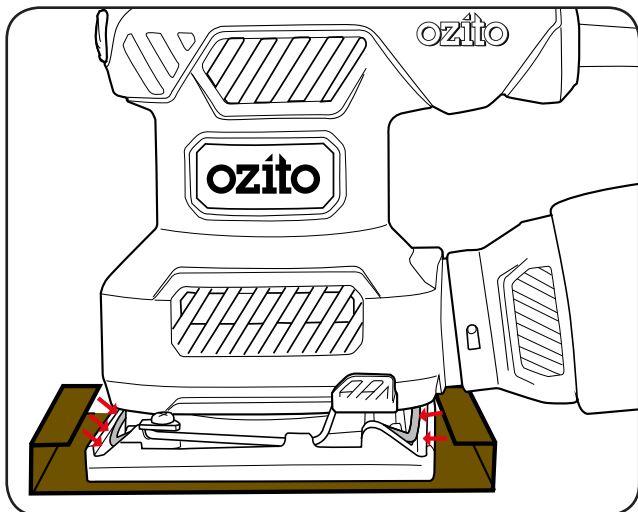

2. Align the sides of the backing pad with the raised sides of the punch. Press down to punch the holes.

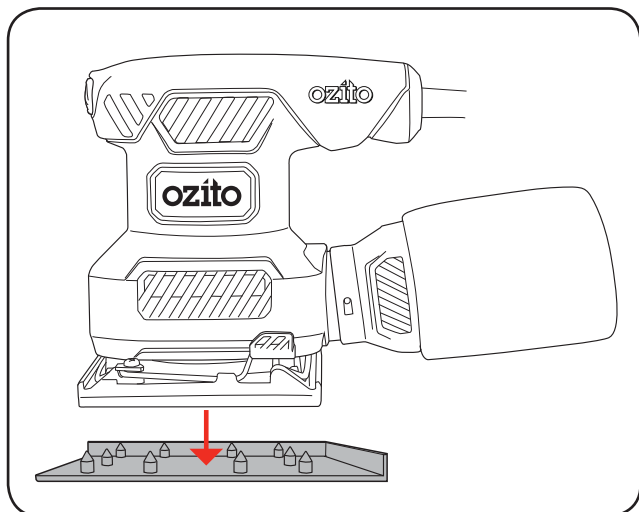

## 3. DUST BAG

### Install

1. Push the dust bag onto the dust extraction port aligning the locking tab and rotate.

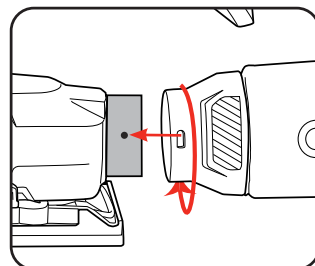

### Remove

2. To remove, rotate and pull the dust bag away from the extraction port.

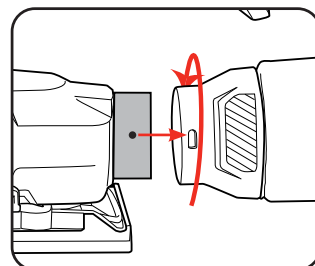

### Empty

3. Empty dust bag when it becomes 1/3 full for optimum dust extraction.

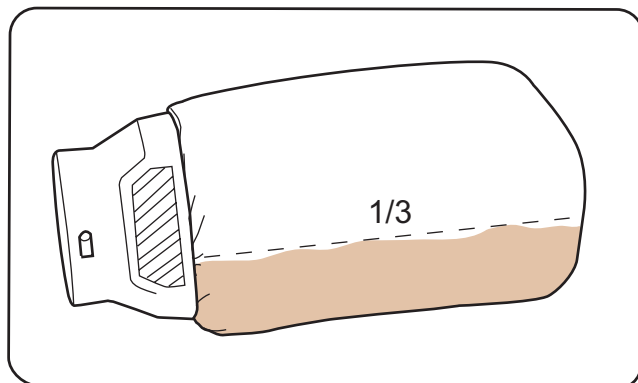

# OPERATION

## 4. ON/OFF SWITCH

The tool is recommended for use with a residual current device with a rated residual current of 30mA or less.

1. Connect the tool to the mains power supply.
2. To turn the sander on, press the on/off switch.

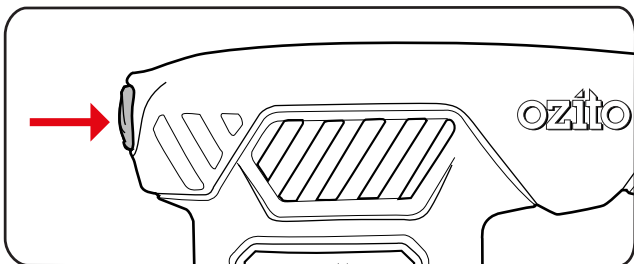

**CAUTION:** GUIDE THE CORD DURING SANDING TO PREVENT IT BEING CAUGHT ON THE WORKPIECE, OR OTHER OBJECTS.

2. To turn the sander off, press the on/off button again.

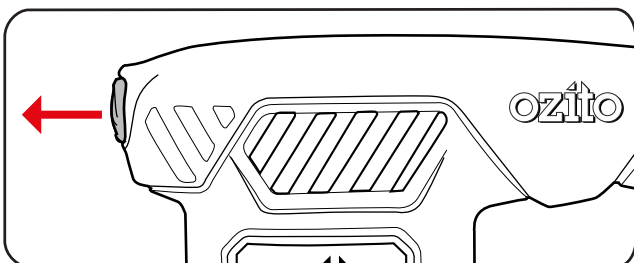

## 5. SANDING

1. Secure the material to be sanded.
2. Firmly grasp the sander. Turn it on and let the motor build up to maximum speed. Gradually lower it onto the workpiece using a forward movement.

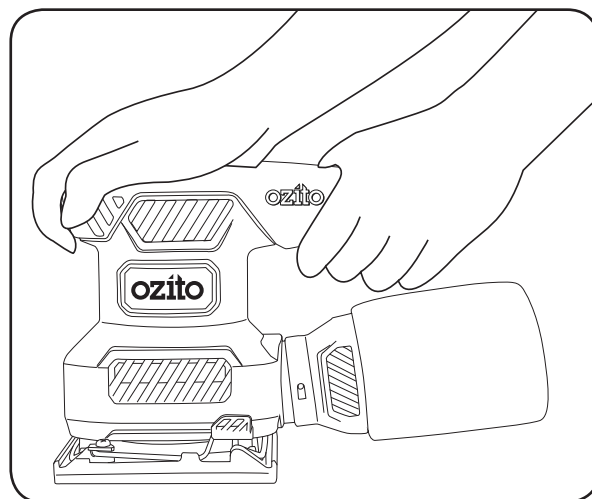

3. For optimum results, use backward and forward strokes.

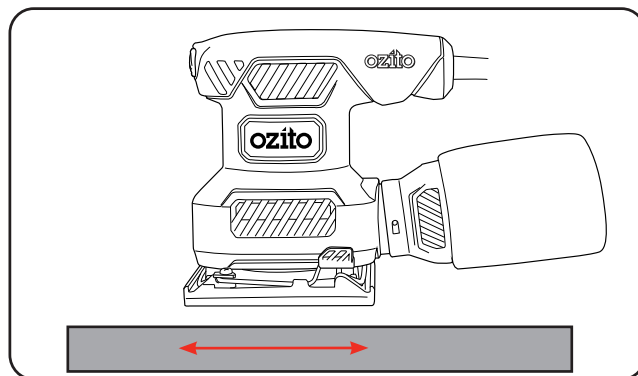

**Note:** Keep the entire sanding pad in contact with the workpiece at all times during sanding.

# MAINTENANCE

- Keep the vents of the sander clean at all times. If possible, prevent foreign matter from entering the vents.
- After each use, blow air through the sander housing to ensure it is free from all dust particles which may build up. Build up of dust particles may cause the sander to overheat and fail.
- If the enclosure of the sander requires cleaning, do not use solvents but a moist soft cloth only. Never let any liquid get inside the sander; never immerse any part of the sander into a liquid.

## Carbon Brushes



When the carbon brushes wear out, the sander will spark and/or stop. Discontinue use as soon as this happens. They should be replaced prior to recommencing use of the sander. Carbon brushes are a wearing component of the sander and are therefore not covered under warranty. Continuing to use the sander when carbon brushes need to be replaced may cause permanent damage to the sander.

Carbon brushes will wear out after many uses. When the carbon brushes need to be replaced, take the sander to an electrician or a power tool repairer for a quick and low cost replacement. Always replace both carbon brushes at the same time.

*Note: Ozito Industries will not be responsible for any damage or injuries caused by the repair of the sander by an unauthorised person or by mishandling of the sander.*

# TROUBLE SHOOTING

## Sparking visible through the housing air vents

A small amount of sparking may be visible through the housing vents. This is normal and does not indicate a problem.

## Excessive sparking visible through the housing air vents and/or the drill failing to operate

May indicate the carbon brushes have worn out and need to be replaced. Carbon brushes should only be replaced by a qualified electrician or power tool repairer.

## Sandpaper Selection

Selecting the correct grit of sandpaper is an important step in achieving optimum results. Coarse grit will remove the most material. Finer grit will produce a smoother finish. The condition of the workpiece will determine the grit of the sandpaper to be used. The higher the grit number, the finer the grade of sandpaper.

If the surface is rough, start with a coarse grit and sand until the surface is uniform. Medium grit may then be used to remove scratches left by the coarser grit. Finer grit is then used to finish the surface. Always continue sanding with each grade of sandpaper until the surface is uniform.

MATERIAL	APPROPRIATE GRIT	
	Coarse Sanding	Fine Sanding
Paintwork	180	400
Wood: Softwood	60	240
Hardwood	60	180
Veneer	240	320

**Note:** If intermediate sanding is required, choose a grit rating between coarse and fine. The above table is intended as a guide only. To ensure a satisfactory result, a small, inconspicuous area should first be tested to ensure the grit of sandpaper chosen is suitable for the desired finish.

## Sanding Tips

Never force the sander. The weight of the sander supplies adequate pressure, allowing the sandpaper to do the work. Applying additional pressure will slow the motor, rapidly wear the sandpaper, and greatly reduce the sander speed. This will slow the removal rate and produce an inferior quality surface.

**CAUTION:** Excessive pressure will overload the motor, causing possible damage to the sander by overheating the motor; or damage to the workpiece.

Be sure to check your workpiece often. The sander is capable of removing material rapidly, especially with coarse paper.

The orbital action of your sander allows you to sand with the grain, or at any angle across it for most sanding jobs. In the final stages a better finish will be achieved by sanding with the grain.

Do not sand on one spot for too long. The sander's rapid action may remove too much material, creating an uneven surface.

# DESCRIPTION OF SYMBOLS

<b>V</b>	Volts	<b>Hz</b>	Hertz
<b>~</b>	Alternating current	<b>W</b>	Watts
<b>/min</b>	Revolutions or reciprocation per minute	<b>n<sub>o</sub></b>	No load speed
<b>/bpm</b>	Orbital per minute	<b>∅</b>	Diameter
	Double insulated		Read Instruction Manual
	Warning		

# SPARE PARTS

Spare parts can be ordered from the Special Orders Desk at your local Bunnings Warehouse or Homebase store.

For further information, or any parts visit

[www.ozito-diy.co.uk](http://www.ozito-diy.co.uk) or contact Ozito Customer Service:

Great Britain: 0151 294 4488

Ireland: 1850 882711

E-mail: [enquires@ozito-diy.co.uk](mailto:enquires@ozito-diy.co.uk)

# ELECTRICAL SAFETY

 **WARNING!** When using mains-powered tools, basic safety precautions, including the following, should always be followed to reduce risk of fire, electric shock, personal injury and material damage.

Read the whole manual carefully and make sure you know how to switch the tool off in an emergency, before operating the tool.

Save these instructions and other documents supplied with this tool for future reference.

Before you connect the equipment to the mains supply make sure that the data on the rating plate are identical to the mains data.



This tool is double insulated therefore no earth wire is required.

If the supply cord of this power tool is damaged, it must be replaced by a specially prepared cord available through the service organization.

**Note:** Double insulation does not take the place of normal safety precautions when operating this tool. The insulation system is for added protection against injury resulting from a possible electrical insulation failure within the tool.

## Using an Extension Lead

Always use an approved extension lead suitable for the power input of this tool. Before use, inspect the extension lead for signs of damage, wear and ageing. Replace the extension lead if damaged or defective. When using an extension lead on a reel, always unwind the lead completely. Use of an extension lead not suitable for the power input of the tool or which is damaged or defective may result in a risk of fire and electric shock.

# GENERAL POWER TOOL SAFETY WARNINGS

 **WARNING!** Read all safety warnings and all instructions. Failure to follow the warnings and instructions may result in electric shock, fire and/or serious injury. Save all warnings and instructions for future reference. The term “power tool” in the warnings refers to your mains-operated (corded) power tool or battery-operated (cordless) power tool.

## 1. Work area safety

- Keep work area clean and well lit. Cluttered or dark areas invite accidents.
- Do not operate power tools in explosive atmospheres, such as in the presence of flammable liquids, gases or dust. Power tools create sparks which may ignite the dust or fumes.
- Keep children and bystanders away while operating a power tool. Distractions can cause you to lose control.

## 2. Electrical safety

- Power tool plugs must match the outlet. Never modify the plug in any way. Do not use any adapter plugs with earthed (grounded) power tools. Unmodified plugs and matching outlets will reduce risk of electric shock.
- Avoid body contact with earthed or grounded surfaces, such as pipes, radiators, ranges and refrigerators. There is an increased risk of electric shock if your body is earthed or grounded.
- Do not expose power tools to rain or wet conditions. Water entering a power tool will increase the risk of electric shock.
- Do not abuse the cord. Never use the cord for carrying, pulling or unplugging the power tool. Keep cord away from heat, oil, sharp edges or moving parts. Damaged or entangled cords increase the risk of electric shock.
- When operating a power tool outdoors, use an extension cord suitable for outdoor use. Use of a cord suitable for outdoor use reduces the risk of electric shock.
- If operating a power tool in a damp location is unavoidable, use a residual current device (RCD) protected supply. Use of an RCD reduces the risk of electric shock.

## 3. Personal safety

- Stay alert, watch what you are doing and use common sense when operating a power tool. Do not use a power tool while you are tired or under the influence of drugs, alcohol or medication. A moment of inattention while operating power tools may result in serious personal injury.
- Use personal protective equipment. Always wear eye protection. Protective equipment such as dust mask, non-skid safety shoes, hard hat, or hearing protection used for appropriate conditions will reduce personal injuries.
- Prevent unintentional starting. Ensure the switch is in the off-position before connecting to power source and/or battery pack, picking up or carrying the tool. Carrying power tools with your finger on the switch or energising power tools that have the switch on invites accidents.

- Remove any adjusting key or wrench before turning the power tool on. A wrench or a key left attached to a rotating part of the power tool may result in personal injury.
  - Do not overreach. Keep proper footing and balance at all times. This enables better control of the power tool in unexpected situations.
  - Dress properly. Do not wear loose clothing or jewellery. Keep your hair, clothing and gloves away from moving parts. Loose clothes, jewellery or long hair can be caught in moving parts.
  - If devices are provided for the connection of dust extraction and collection facilities, ensure these are connected and properly used. Use of dust collection can reduce dust-related hazards.
- ## 4. Power tool use and care
- Do not force the power tool. Use the correct power tool for your application. The correct power tool will do the job better and safer at the rate for which it was designed.
  - Do not use the power tool if the switch does not turn it on and off. Any power tool that cannot be controlled with the switch is dangerous and must be repaired.
  - Disconnect the plug from the power source and/or the battery pack from the power tool before making any adjustments, changing accessories, or storing power tools. Such preventive safety measures reduce the risk of starting the power tool accidentally.
  - Store idle power tools out of the reach of children and do not allow persons unfamiliar with the power tool or these instructions to operate the power tool. Power tools are dangerous in the hands of untrained users.
  - Maintain power tools. Check for misalignment or binding of moving parts, breakage of parts and any other condition that may affect the power tool's operation. If damaged, have the power tool repaired before use. Many accidents are caused by poorly maintained power tools.
  - Keep cutting tools sharp and clean. Properly maintained cutting tools with sharp cutting edges are less likely to bind and are easier to control.
  - Use the power tool, accessories and tool bits etc. in accordance with these instructions, taking into account the working conditions and the work to be performed. Use of the power tool for operations different from those intended could result in a hazardous situation.
- ## 5. Service
- Have your power tool serviced by a qualified repair person using only identical replacement parts. This will ensure that the safety of the power tool is maintained.

# QUARTER SHEET SANDER SAFETY WARNINGS

 **WARNING!**

- Hold power tool by insulated gripping surfaces, because the sanding pad may contact its own cord. Cutting a “live” wire may make exposed metal parts of the power tool “live” and could give the operator an electric shock.

Recommendation that the tool always be supplied via a residual current device with a rated residual current of 30 mA or less.

Unplug the sander before changing accessories. Accidental start-ups may occur if the sander is plugged in while changing an accessory.

**Disposing of dust.** Be extremely careful of dust disposal, materials in fine particle form may be explosive. Do not throw sanding dust on an open fire. Spontaneous combustion, may in time, result from a mixture of oil or water with dust particles.

**Always wear eye protection and a dust mask for dusty applications and when sanding overhead.** Sanding particles can be absorbed by your eyes and inhaled easily and may cause health complications.

**Use special precautions when sanding chemically pressure treated timber, paint that may be lead based, or any other materials that may contain carcinogens.** A suitable breathing respirator and protective clothing must be worn by all persons entering the work area. Work should be sealed by plastic sheeting and persons not protected should be kept out until work area is thoroughly cleaned.

**Do not ‘wet sand’ with this sander.** Liquids entering the motor housing are an electrical shock hazard.

**Do not use sandpaper intended for larger sanding pads.** Larger sandpaper will extend beyond the sanding pad causing snagging, tearing of the paper or kick-back. Extra paper extending beyond the sanding pad can also cause serious lacerations.

 **WARNING!**

Some dust created by power sanding, sawing, grinding, drilling and other construction activities contain chemicals known to cause cancer, birth defects or other reproductive harm.

Some examples of these chemicals are:

- Lead from lead-based paints;
- Crystalline silica from bricks, cement and other masonry products, and;
- Arsenic and chromium from chemically-treated timber.

Your risk from these exposures varies, depending on how often you do this type of work. To reduce your exposure to these chemicals: work in a well ventilated area and work with approved safety equipment, such as dust masks that are specially designed to filter out microscopic particles.

## Service information

We have competent service partners in all countries named on the guarantee certificate whose contact details can also be found on the guarantee certificate. These partners will help you with all service requests such as repairs, spare and wearing part orders or the purchase of consumables.

Please note that the following parts of this product are subject to normal or natural wear and that the following parts are therefore also required for use as consumables.

Category	Example
Wear parts*	Carbon brushes, grinding/sanding plate
Consumables*	Grinding/sanding paper
Missing parts	

\* Not necessarily included in the scope of delivery!

In the effect of defects or faults, please register the problem on the internet at [www.isc-gmbh.info](http://www.isc-gmbh.info). Please ensure that you provide a precise description of the problem and answer the following questions in all cases:

- Did the equipment work at all or was it defective from the beginning?
- Did you notice anything (symptom or defect) prior to the failure?
- What malfunction does the equipment have in your opinion (main symptom)? Describe this malfunction.

## Declaration of conformity

**ISC GmbH · Eschenstraße 6 · D-94405 Landau/Isar**



explains the following conformity according to EU directives and norms for the following product

**1/4 Sheet Orbital Sander QSS-1000U (Ozito)**

- |   |  |
|---|--|
| <input type="checkbox"/> 2014/29/EU             | <input checked="" type="checkbox"/> 2006/42/EC   |
| <input type="checkbox"/> 2005/32/EC_2009/125/EC | <input type="checkbox"/> Annex IV<br>Notified Body:<br>Notified Body No.:<br>Reg. No.:   |
| <input type="checkbox"/> 2014/35/EU             |  |
| <input type="checkbox"/> 2006/28/EC             | <input type="checkbox"/> 2000/14/EC_2005/88/EC   |
| <input checked="" type="checkbox"/> 2014/30/EU  | <input type="checkbox"/> Annex V   |
| <input type="checkbox"/> 2014/32/EU             | <input type="checkbox"/> Annex VI<br>Noise: measured $L_{wa}$ = dB (A); guaranteed $L_{wa}$ = dB (A)<br>P = KW; L/Ø = cm<br>Notified Body: |
| <input type="checkbox"/> 2014/53/EC             |  |
| <input type="checkbox"/> 2014/68/EU             | <input type="checkbox"/> 2004/26/EC<br>Emission No.:   |
| <input type="checkbox"/> 90/396/EC_2009/142/EC  |  |
| <input type="checkbox"/> 89/686/EC_96/58/EC     |  |
| <input checked="" type="checkbox"/> 2011/65/EU  |  |

**Standard references: EN 60745-1; EN 60745-2-4; EN 55014-1;  
EN 55014-2; EN 61000-3-2; EN 61000-3-3**

Landau/Isar, den 15.07.2016

  
Weichselgartner/General-Manager

  
Mayr/Product-Management

First CE: 16  
Art.-No.: 44.722.57 I.-No.: 11016  
Subject to change without notice

Archive-File/Record: NAPR014349  
Documents registrar: Robert Gehard  
Wiesenweg 22, D-94405 Landau/Isar

**ozito**

**QSS-1000U**

**GB Additional operating & safety instructions Orbital Sander**

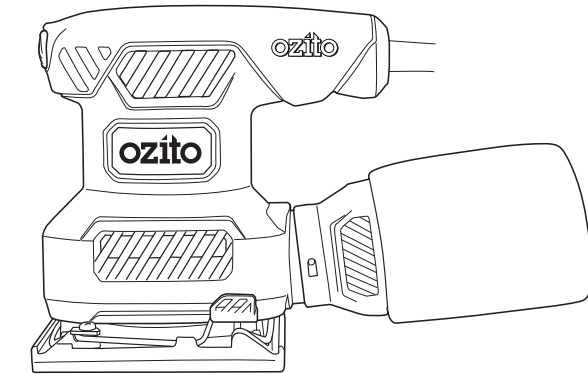

**Danger!** - Read the operating instructions to reduce the risk of injury



**Caution! Wear ear-muffs.** The impact of noise can cause damage to hearing.



**Caution! Wear a breathing mask.** Dust which is injurious to health can be generated when working on wood and other materials. Never use the device to work on any materials containing asbestos!



**Caution! Wear safety goggles.** Sparks generated during working or splinters, chips and dust emitted by the device can cause loss of sight.

The reprinting or reproduction by any other means, in whole or in part, of documentation and papers accompanying products is permitted only with the express consent of the ISC GmbH.

Subject to technical changes

### Items supplied

Please check that the article is complete as specified in the scope of delivery. If parts are missing, please contact our service center or the sales outlet where you made your purchase at the latest within 5 working days after purchasing the product and upon presentation of a valid bill of purchase. Also, refer to the warranty table in the service information at the end of the operating instructions.

- Open the packaging and take out the equipment with care.
- Remove the packaging material and any packaging and/or transportation braces (if available).
- Check to see if all items are supplied.
- Inspect the equipment and accessories for transport damage.
- If possible, please keep the packaging until the end of the guarantee period.

### Danger!

**The equipment and packaging material are not toys. Do not let children play with plastic bags, foils or small parts. There is a danger of swallowing or suffocating!**

### Proper use

The machine is designed for the grinding/sanding of wood, metal, plastic and similar materials using the appropriate grinding/sanding paper. The equipment is not suitable for wet grinding/sanding.

The equipment is to be used only for its prescribed purpose. Any other use is deemed to be a case of misuse. The user / operator and not the manufacturer will be liable for any damage or injuries of any kind caused as a result of this.

Please note that our equipment has not been designed for use in commercial, trade or industrial applications. Our warranty will be voided if the machine is used in commercial, trade or industrial businesses or for equivalent purposes.

### Technical data

Voltage..... 230-240 V ~ 50 Hz  
Power input..... 135 W  
Grinding/sanding area ..... 100 x 110 mm  
Abrasive paper size ..... 140 x 110 mm  
No load speed ..... 13,000/min  
Oscillatory circuit ..... 1.5 mm  
Protection class: ..... II/□

### Sound and vibration

Sound and vibration values were measured in accordance with EN 60745.

$L_{pA}$  sound pressure level ..... 79 dB(A)  
 $K_{pA}$  uncertainty ..... 3 dB  
 $L_{WA}$  sound power level ..... 90 dB(A)  
 $K_{WA}$  uncertainty ..... 3 dB

### Wear ear-muffs.

The impact of noise can cause damage to hearing.

Total vibration values (vector sum of three directions) determined in accordance with EN 60745.

### Handle

Vibration emission value  $a_h = 6.711 \text{ m/s}^2$   
K uncertainty = 1.5  $\text{m/s}^2$

The specified vibration value was established in accordance with a standardized testing method. It may change according to how the electric equipment is used and may exceed the specified value in exceptional circumstances.

The specified vibration value can be used to compare the equipment with other electric power tools.

The specified vibration value can be used for initial assessment of a harmful effect.

### Keep the noise emissions and vibrations to a minimum.

- Only use appliances which are in perfect working order.
- Service and clean the appliance regularly.
- Adapt your working style to suit the appliance.
- Do not overload the appliance.
- Have the appliance serviced whenever necessary.
- Switch the appliance off when it is not in use.
- Wear protective gloves.

### Caution!

#### Residual risks

**Even if you use this electric power tool in accordance with instructions, certain residual risks cannot be ruled out. The following hazards may arise in connection with the equipment's construction and layout:**

1. Lung damage if no suitable protective dust mask is used.
2. Damage to hearing if no suitable ear protection is used.
3. Health damage caused by hand-arm vibrations if the equipment is used over a prolonged period or is not properly guided and maintained.



For EU countries only

Never place any electric power tools in your household refuse.

To comply with European Directive 2012/19/EC concerning old electric and electronic equipment and its implementation in national laws, old electric power tools have to be separated from other waste and disposed of in an environment-friendly fashion, e.g. by taking to a recycling depot.

Recycling alternative to the return request:

As an alternative to returning the equipment to the manufacturer, the owner of the electrical equipment must make sure that the equipment is properly disposed of if he no longer wants to keep the equipment. The old equipment can be returned to a suitable collection point that will dispose of the equipment in accordance with the national recycling and waste disposal regulations. This does not apply to any accessories or aids without electrical components supplied with the old equipment.