

ozito

BUFFER POLISHER

110W

ORIGINAL INSTRUCTIONS

SPECIFICATIONS

Voltage:	230V ~ 50Hz
Power:	110W
No Load Speed:	3,200/min
Buffing Pad Diameter:	240mm (10")
Orbital Diameter:	12.7mm (1/2")
Weight:	3.65kg

ozito-diy.co.uk

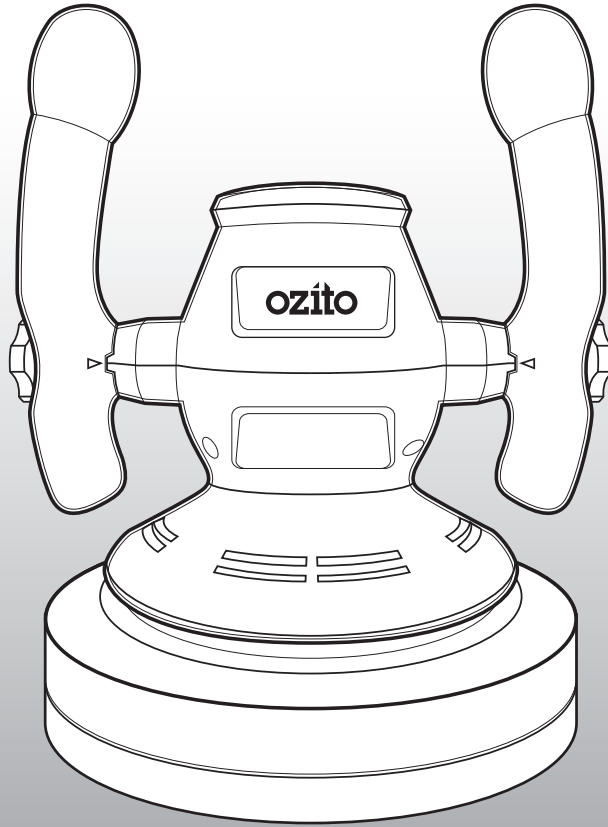

WHAT'S IN THE BOX

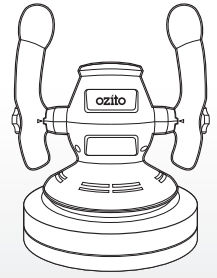

Buffer Polisher

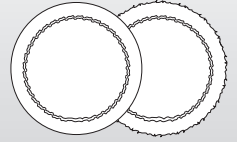

Applicator Bonnet
& Polishing Bonnet

3 YEAR REPLACEMENT WARRANTY

OZBP110WAU

WARRANTY

All of our products undergo strict quality checks to ensure that they reach you in perfect condition. In the unlikely event that your device develops a fault, please contact our service department at the address shown on this guarantee card. You can also contact us by telephone using the customer service number shown. Please note the following terms under which guarantee claims can be made:

1. These warranty terms regulate additional warranty services, which the manufacturer mentioned below promises to buyers of its new products in addition to their statutory guarantee claims are not affected by this guarantee. Our guarantee is free of charge to you.
2. The warranty services only covers defects due to material or manufacturing faults on a product which you have bought from the manufacturer mentioned below are limited to either the rectification of said defects on the product or the replacement of the product, whichever we prefer.
Please note that our devices are not designed for use in commercial, trade or professional applications. A guarantee contract will not be created if the device has been used by commercial, trade or industrial business or has been exposed to similar stresses during the guarantee period.
3. The following are not covered by our guarantee:
 - Damage to the device caused by a failure to follow the assembly instructions or due to incorrect installation, a failure to follow the operating instructions (for example connecting it to an incorrect mains voltage or current type) or a failure to follow the maintenance and safety instructions or by exposing the device to abnormal environmental conditions or by lack of care and maintenance.
 - Damage to the device caused by abuse or incorrect use (for example overloading the device or the use of unapproved tools or accessories), ingress of foreign bodies into the device (such as sand, stones or dust, transport damage), the use of force or damage caused by external forces (for example by dropping it).

- Damage to the device or parts of the device caused by normal or natural wear or tear or by normal use of the device.

4. Your Product is guaranteed for a period of 36 months from the original date of purchase and is intended for DIY (Do It Yourself) use only. Lithium Ion batteries and chargers are covered by a 12 month warranty. Warranty excludes consumable parts. Guarantee claims should be submitted before the end of the guarantee period within two weeks of the defect being noticed. No guarantee claims will be accepted after the end of the guarantee period. The original guarantee period remains applicable to the device even if repairs are carried out or parts are replaced. In such cases, the work performed or parts fitted will not result in an extension of the guarantee period, and no new guarantee will become active for the work performed or parts fitted. This also applies if an on-site service is used.

IN ORDER TO MAKE A CLAIM UNDER THIS WARRANTY YOU MUST RETURN THE PRODUCT TO THE PLACE OF PURCHASE WITH YOUR REGISTER RECEIPT.

Please refer to the restrictions of this warranty concerning wearing parts, consumables and missing parts as set out in the service information in these operating instructions.

CUSTOMER SERVICE HELPLINE
GB: 0151 294 4488
IRL: 1850 882711
Ozito-diy.co.uk

KNOW YOUR PRODUCT

BUFFER POLISHER

- | | |
|---------------------------|-----------------|
| 1 Motor cover | 5 Foam pad |
| 2 Motor housing | 6 On/Off switch |
| 3 Adjustable handle knobs | 7 Cordset |
| 4 Adjustable handle | |

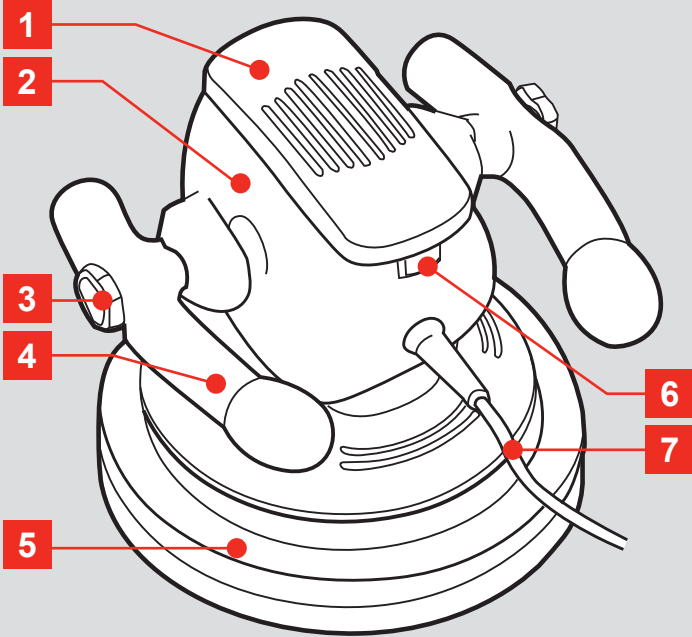

ACCESSORIES

- | | |
|---------------------|--------------------|
| 8 Applicator bonnet | 9 Polishing bonnet |
|---------------------|--------------------|

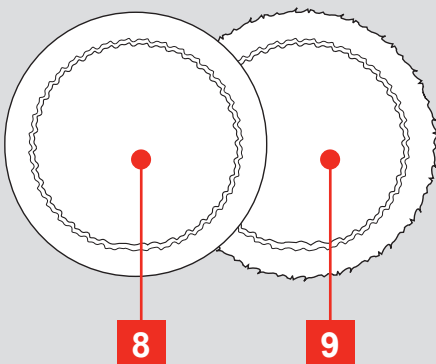

ONLINE MANUAL

Scan this QR Code with your mobile device to take you to the online manual.



SETUP & PREPARATION

1. ADJUSTING THE HANDLES



WARNING: ENSURE THE TOOL IS TURNED OFF AND DISCONNECTED FROM THE POWER SUPPLY BEFORE PERFORMING ANY OF THE FOLLOWING OPERATIONS.

Each handle adjusts to 3 positions (forward horizontal, vertical and backward horizontal). These positions allow for the user to choose the most comfortable configuration for the task.

- 1 Loosen the handle knob by rotating anti-clockwise.

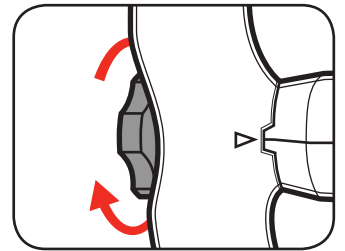

- 2 Rotate the handle into the desired position ensuring the tabs align with the recess of the handle.

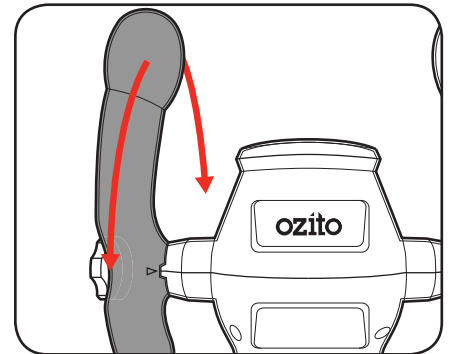

- 3 Secure in place by tightening the handle knob by hand.

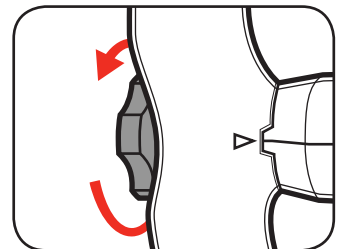

- 4 Repeat this process for the second adjustable handle.

3 YEAR REPLACEMENT WARRANTY

OPERATION

2. ATTACHING THE BONNETS

Attaching the Bonnet

- 1 Pull the bonnet over one side of the foam pad.

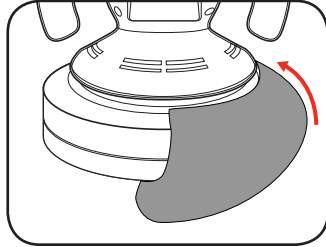

- 2 Pull the remaining bonnet over the foam pad.

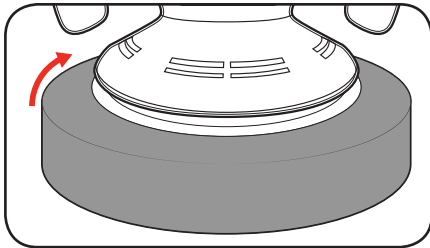

Removing the Bonnet

- 1 Pull one side of the bonnet off the foam pad.

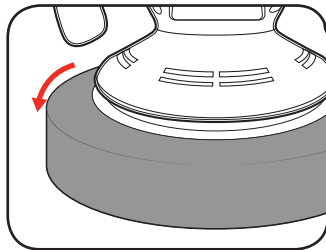

- 2 Slide the bonnet off the foam pad.

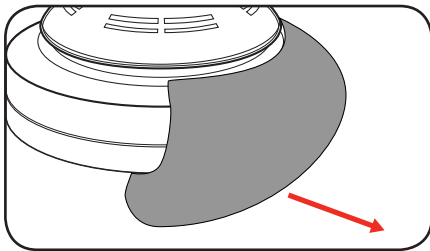

3. SWITCHING ON & OFF



WARNING: THE POWER SUPPLY FOR THIS PRODUCT SHOULD BE PROTECTED BY A RESIDUAL CURRENT DEVICE RATED AT 30mA OR LESS.

Before Polishing

Test a small inconspicuous area of the surface.

Refer to polish manufacturer's instructions regarding application and drying times.

Using too much polish may:

- Reduce the life of the foam pad
- Make polishing difficult and take longer
- Cause bonnet to come off

Note: Never use abrasive compounds.

Switching On and Off

- 1 Press the on/off switch to the on position "I" to start the polisher.

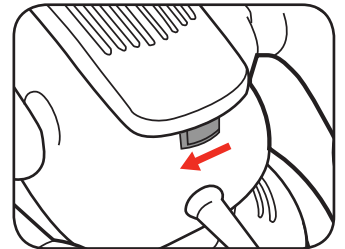

- 2 Press the on/off switch to the off position "0" to stop the polisher.

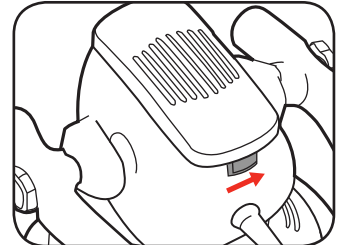

4. APPLICATION

- 1 Ensure a clean application bonnet is fitted to the foam pad.

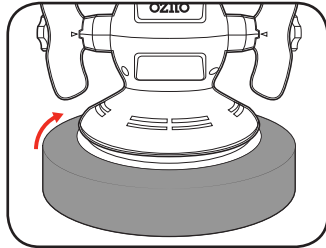

- 2 Hold the polisher away from the surface and start by pressing the on/off switch into the on position.

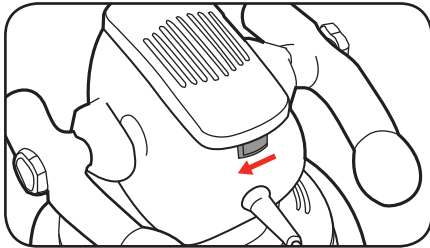

- 3 Allow the motor to reach maximum speed. Move the polisher onto the surface using long sweeping strokes in a crisscross pattern.

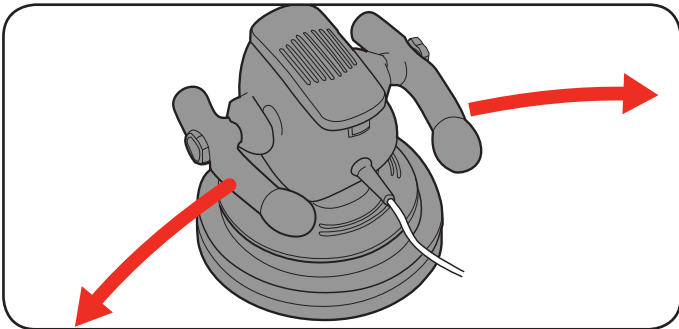

Note: Do not apply excessive force to the polisher. Allow the polisher to do the work.

Note: Never use the polishing bonnet to apply polish to a surface.

5. POLISHING

- 1 Ensure a clean polishing bonnet is fitted to the foam pad and the compound has been evenly applied to the surface.

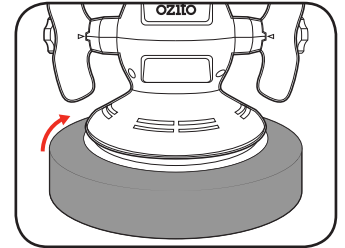

- 2 Hold the polisher away from the surface and start by pressing the on/off switch into the on position.

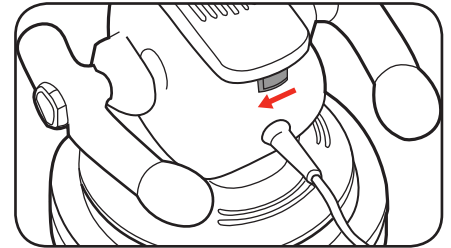

- 3 Allow the motor to reach maximum speed. Move the polisher onto the surface using long sweeping strokes in a crisscross pattern.

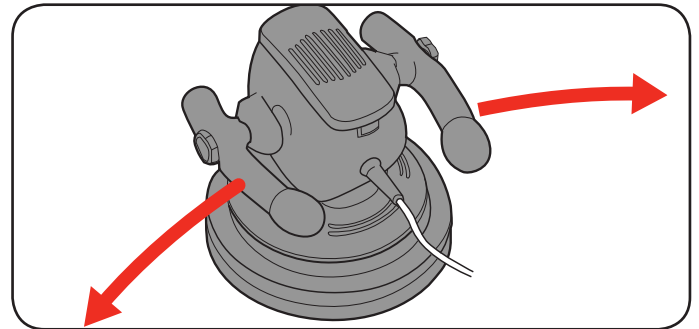

Note: Do not apply excessive force to the polisher. Allow the polisher to do the work.

Note: If the polish seems too difficult to buff, you may have applied too much polish.

MAINTENANCE

- The bonnets are machine washable in cold water. However hand washing will extend the life of the bonnet.
- Always store the polisher with the foam pad facing up to extend the life and shape.
- When not in use, remove bonnet from the foam pad. This will ensure that the foam pad will dry out and retain its shape.
- Keep the vents of the polisher clean at all times. If possible, prevent foreign matter from entering the vents.
- After each use, blow air through the polisher housing to ensure it is free from all dust particles which may build up. Build up of dust particles may cause the polisher to overheat and fail.
- If the enclosure of the polisher requires cleaning, do not use solvents but a moist soft cloth only. Never let any liquid get inside the polisher; never immerse any part of the polisher into a liquid.

Carbon Brushes

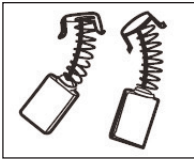

When the carbon brushes wear out, the polisher will spark and/or stop. Discontinue use as soon as this happens. They should be replaced prior to recommencing use of the polisher. Carbon brushes are a wearing component of the polisher and are therefore not covered under warranty. Continuing to use the polisher when carbon brushes need to be replaced may cause permanent damage to the

polisher. Carbon brushes will wear out after many uses. When the carbon brushes need to be replaced, take the polisher to an electrician or a power tool repairer for a quick and low cost replacement. Always replace both carbon brushes at the same time.

Note: Ozito Industries will not be responsible for any damage or injuries caused by the repair of the polisher by an unauthorised person or by mishandling of the polisher.

Removing the Foam Pad

- 1 Insert a long-bladed screwdriver between the foam pad and the motor housing to stop the spindle moving.

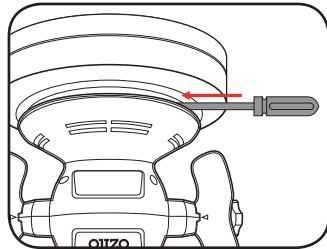

- 2 Using a flat-bladed screwdriver, remove the screw folding the foam pad by turning it clockwise.

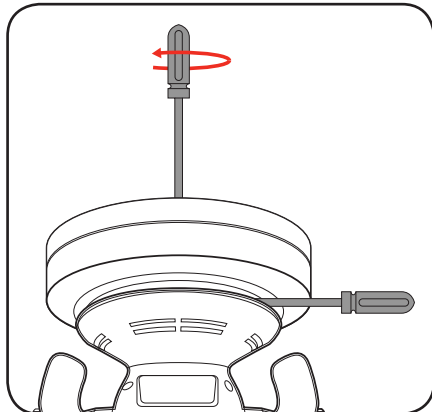

- 3 To reinstall the foam pad, screw anti-clockwise.

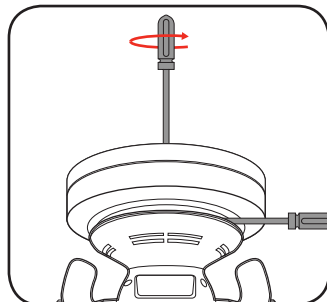

TROUBLE SHOOTING

Sparking visible through the housing air vents

A small amount of sparking may be visible through the housing vents. This is normal and does not indicate a problem.

Excessive sparking visible through the housing air vents and/or the drill failing to operate

May indicate the carbon brushes have worn out and need to be replaced. Carbon brushes should only be replaced by a qualified electrician or power tool repairer.

Operation Tips

Never force the buffer polisher. The weight of the unit supplies adequate pressure, allowing the discs to do the work. Applying additional pressure will slow the motor, rapidly wear the discs, and greatly reduce the rotational speed. This will slow the removal rate and produce an inferior quality surface.

CAUTION: Excessive pressure will overload the motor, causing possible damage to the buffer polisher by overheating the motor; or damage to the workpiece.

Do not polish on one spot for too long. The polisher's rapid action may remove too much material, creating an uneven surface.

SPARE PARTS

Spare parts can be ordered from the Special Orders Desk at your local Bunnings Warehouse or Homebase store.

For further information, or any parts visit



www.ozito-diy.co.uk or contact Ozito Customer Service:

Great Britain: 0151 294 4488

Ireland: 1850 882711

E-mail: enquires@ozito-diy.co.uk

DESCRIPTION OF SYMBOLS

V	Volts	Hz	Hertz
~	Alternating current	W	Watts
/min	Revolutions or reciprocation per minute	n₀	No load speed
	Double insulated		Read instruction manual
	Warning		

ELECTRICAL SAFETY

 **WARNING!** When using mains-powered tools, basic safety precautions, including the following, should always be followed to reduce risk of fire, electric shock, personal injury and material damage.

Read the whole manual carefully and make sure you know how to switch the tool off in an emergency, before operating the tool.

Save these instructions and other documents supplied with this tool for future reference.

Before you connect the equipment to the mains supply make sure that the data on the rating plate are identical to the mains data.



This tool is double insulated therefore no earth wire is required.

If the supply cord of this power tool is damaged, it must be replaced by a specially prepared cord available through the service organization.

Note: Double insulation does not take the place of normal safety precautions when operating this tool. The insulation system is for added protection against injury resulting from a possible electrical insulation failure within the tool.

Using an Extension Lead

Always use an approved extension lead suitable for the power input of this tool. Before use, inspect the extension lead for signs of damage, wear and ageing. Replace the extension lead if damaged or defective. When using an extension lead on a reel, always unwind the lead completely. Use of an extension lead not suitable for the power input of the tool or which is damaged or defective may result in a risk of fire and electric shock.

To reduce the risk of electrical shock, a residual current device (rated 30mA or less) should be used.

GENERAL POWER TOOL SAFETY WARNINGS

 **WARNING!** Read all safety warnings and all instructions. Failure to follow the warnings and instructions may result in electric shock, fire and/or serious injury. Save all warnings and instructions for future reference. The term “power tool” in the warnings refers to your mains-operated (corded) power tool or battery-operated (cordless) power tool.

1. Work area safety

- Keep work area clean and well lit. Cluttered or dark areas invite accidents.
 - Do not operate power tools in explosive atmospheres, such as in the presence of flammable liquids, gases or dust. Power tools create sparks which may ignite the dust or fumes.
 - Keep children and bystanders away while operating a power tool. Distractions can cause you to lose control.
- ## 2. Electrical safety
- Power tool plugs must match the outlet. Never modify the plug in any way. Do not use any adapter plugs with earthed (grounded) power tools. Unmodified plugs and matching outlets will reduce risk of electric shock.
 - Avoid body contact with earthed or grounded surfaces, such as pipes, radiators, ranges and refrigerators. There is an increased risk of electric shock if your body is earthed or grounded.
 - Do not expose power tools to rain or wet conditions. Water entering a power tool will increase the risk of electric shock.
 - Do not abuse the cord. Never use the cord for carrying, pulling or unplugging the power tool. Keep cord away from heat, oil, sharp edges or moving parts. Damaged or entangled cords increase the risk of electric shock.
 - When operating a power tool outdoors, use an extension cord suitable for outdoor use. Use of a cord suitable for outdoor use reduces the risk of electric shock.
 - If operating a power tool in a damp location is unavoidable, use a residual current device (RCD) protected supply. Use of an RCD reduces the risk of electric shock.

3. Personal safety

- Stay alert, watch what you are doing and use common sense when operating a power tool. Do not use a power tool while you are tired or under the influence of drugs, alcohol or medication. A moment of inattention while operating power tools may result in serious personal injury.
- Use personal protective equipment. Always wear eye protection. Protective equipment such as dust mask, non-skid safety shoes, hard hat, or hearing protection used for appropriate conditions will reduce personal injuries.
- Prevent unintentional starting. Ensure the switch is in the off-position before connecting to power source and/or battery pack, picking up or carrying the tool. Carrying power tools with your finger on the switch or energising power tools that have the switch on invites accidents.

- Remove any adjusting key or wrench before turning the power tool on. A wrench or a key left attached to a rotating part of the power tool may result in personal injury.
 - Do not overreach. Keep proper footing and balance at all times. This enables better control of the power tool in unexpected situations.
 - Dress properly. Do not wear loose clothing or jewellery. Keep your hair, clothing and gloves away from moving parts. Loose clothes, jewellery or long hair can be caught in moving parts.
 - If devices are provided for the connection of dust extraction and collection facilities, ensure these are connected and properly used. Use of dust collection can reduce dust-related hazards.
- ## 4. Power tool use and care
- Do not force the power tool. Use the correct power tool for your application. The correct power tool will do the job better and safer at the rate for which it was designed.
 - Do not use the power tool if the switch does not turn it on and off. Any power tool that cannot be controlled with the switch is dangerous and must be repaired.
 - Disconnect the plug from the power source and/or the battery pack from the power tool before making any adjustments, changing accessories, or storing power tools. Such preventive safety measures reduce the risk of starting the power tool accidentally.
 - Store idle power tools out of the reach of children and do not allow persons unfamiliar with the power tool or these instructions to operate the power tool. Power tools are dangerous in the hands of untrained users.
 - Maintain power tools. Check for misalignment or binding of moving parts, breakage of parts and any other condition that may affect the power tool's operation. If damaged, have the power tool repaired before use. Many accidents are caused by poorly maintained power tools.
 - Keep cutting tools sharp and clean. Properly maintained cutting tools with sharp cutting edges are less likely to bind and are easier to control.
 - Use the power tool, accessories and tool bits etc. in accordance with these instructions, taking into account the working conditions and the work to be performed. Use of the power tool for operations different from those intended could result in a hazardous situation.
- ## 5. Service
- Have your power tool serviced by a qualified repair person using only identical replacement parts. This will ensure that the safety of the power tool is maintained.

BUFFER POLISHER SAFETY WARNINGS

 **WARNING!** Hold power tool by insulated gripping surfaces, because the pad may contact its own cord. Cutting a “live” wire may make exposed metal parts of the power tool “live” and could give the operator an electric shock.

This power tool is intended to function as a polisher. Read all safety warnings, instructions, illustrations and specifications provided with this power tool. Failure to follow all instructions listed below may result in electric shock, fire and/or serious injury.

Operations such as grinding, sanding, wire brushing, or cutting-off are not recommended to be performed with this power tool. Operations for which the power tool was not designed may create a hazard and cause personal injury.

Do not use accessories which are not specifically designed and recommended by the tool manufacturer. Just because the accessory can be attached to your power tool, it does not assure safe operation.

The rated speed of the accessory must be at least equal to the maximum speed marked on the power tool. Accessories running faster than their rated speed can break and fly apart.

Do not allow any loose portion of the polishing bonnet or its attachment strings to spin freely. Tuck away or trim any loose attachment strings. Loose and spinning attachment strings can entangle your fingers or snag on the workpiece.

Wear personal protective equipment. Depending on application, use face shield, safety goggles or safety glasses. As appropriate, wear dust mask, hearing protectors, gloves and workshop apron capable of stopping small abrasive or workpiece fragments. The eye protection must be capable of stopping flying debris generated by various operations. The dust mask or respirator must be capable of filtering particles generated by your operation. Prolonged exposure to high intensity noise may cause hearing loss.

Keep bystanders a safe distance away from work area. Anyone entering the work area must wear personal protective equipment. Fragments of workpiece or of a broken accessory may fly away and cause injury beyond immediate area of operation.

Position the cord clear of the spinning accessory. If you lose control, the cord may be cut or snagged and your hand or arm may be pulled into the spinning accessory.

Never lay the power tool down until the accessory has come to a complete stop. The spinning accessory may grab the surface and pull the power tool out of your control.

Do not run the power tool while carrying it at your side. Accidental contact with the spinning accessory could snag your clothing, pulling the accessory into your body.

Regularly clean the power tool's air vents. The motor's fan will draw the dust inside the housing and excessive accumulation of powdered metal may cause electrical hazards.

Do not operate the power tool near flammable materials. Sparks could ignite these materials.

Do not use accessories that require liquid coolants. Using water or other liquid coolants may result in electrocution or shock.

 **WARNING!** Some dust created by power sanding, sawing, grinding, drilling and other construction activities contain chemicals known to cause cancer, birth defects or other reproductive harm.

Some examples of these chemicals are:

- Lead from lead-based paints;
- Crystalline silica from bricks, cement and other masonry products, and;
- Arsenic and chromium from chemically-treated timber.

Your risk from these exposures varies, depending on how often you do this type of work. To reduce your exposure to these chemicals: work in a well ventilated area and work with approved safety equipment, such as dust masks that are specially designed to filter out microscopic particles.

Kickback and Related Warnings

Kickback is a sudden reaction to a pinched or snagged rotating wheel, backing pad, brush or any other accessory. Pinching or snagging causes rapid stalling of the rotating accessory which in turn causes the uncontrolled power tool to be forced in the direction opposite of the accessory's rotation at the point of the binding. Kickback is the result of power tool misuse and/or incorrect operating procedures or conditions and can be avoided by taking proper precautions as given below.

- Maintain a firm grip on the power tool and position your body and arm to allow you to resist kickback forces. Always use auxiliary handle, if provided, for maximum control over kickback or torque reaction during start-up. The operator can control torque reactions or kickback forces, if proper precautions are taken.
- Never place your hand near the rotating accessory. Accessory may kickback over your hand.
- Do not position your body in the area where power tool will move if kickback occurs. Kickback will propel the tool in direction opposite to the wheel's movement at the point of snagging.
- Use special care when working corners, sharp edges etc. Avoid bouncing and snagging the accessory. Corners, sharp edges or bouncing have a tendency to snag the rotating accessory and cause loss of control or kickback.

Service information

We have competent service partners in all countries named on the guarantee certificate whose contact details can also be found on the guarantee certificate. These partners will help you with all service requests such as repairs, spare and wearing part orders or the purchase of consumables.

Please note that the following parts of this product are subject to normal or natural wear and that the following parts are therefore also required for use as consumables.

Category	Example
Wear parts*	
Consumables*	Grinding wheels, polishing attachments, polishing bonnets, Carbon brushes
Missing parts	

* Not necessarily included in the scope of delivery!

In the effect of defects or faults, please register the problem on the internet at www.isc-gmbh.info. Please ensure that you provide a precise description of the problem and answer the following questions in all cases:

- Did the equipment work at all or was it defective from the beginning?
- Did you notice anything (symptom or defect) prior to the failure?
- What malfunction does the equipment have in your opinion (main symptom)? Describe this malfunction.

Declaration of conformity

ISC GmbH · Eschenstraße 6 · D-94405 Landau/Isar



explains the following conformity according to EU directives and norms for the following product

Buffer Polisher OZBP110WAU (Ozito)

- | | |
|---|--|
| <input type="checkbox"/> 2014/29/EU | <input checked="" type="checkbox"/> 2006/42/EC |
| <input type="checkbox"/> 2005/32/EC_2009/125/EC | <input type="checkbox"/> Annex IV
Notified Body:
Notified Body No.:
Reg. No.: |
| <input type="checkbox"/> 2014/35/EU | |
| <input type="checkbox"/> 2006/28/EC | <input type="checkbox"/> 2000/14/EC_2005/88/EC |
| <input checked="" type="checkbox"/> 2014/30/EU | <input type="checkbox"/> Annex V |
| <input type="checkbox"/> 2014/32/EU | <input type="checkbox"/> Annex VI
Noise: measured L_{WA} = dB (A); guaranteed L_{WA} = dB (A)
P = KW; L/Ø = cm
Notified Body: |
| <input type="checkbox"/> 2014/53/EC | |
| <input type="checkbox"/> 2014/68/EU | <input type="checkbox"/> 2004/26/EC
Emission No.: |
| <input type="checkbox"/> 90/396/EC_2009/142/EC | |
| <input type="checkbox"/> 89/686/EC_96/58/EC | |
| <input checked="" type="checkbox"/> 2011/65/EU | |

Standard references: EN 60745-1; EN 60745-2-4; EN 55014-1;
EN 55014-2; EN 61000-3-2; EN 61000-3-3

Landau/Isar, den 13.06.2016

Weichselgartner/General-Manager

Yang/Product-Management

First CE: 16
Art.-No.: 44.722.18 I.-No.: 11016
Subject to change without notice

Archive-File/Record: NAPR014346
Documents registrar: R. Gehard
Wiesenweg 22, D-94405 Landau/Isar

ozito

OZBP110WAU

GB Additional operating & safety instructions Buffer Polisher

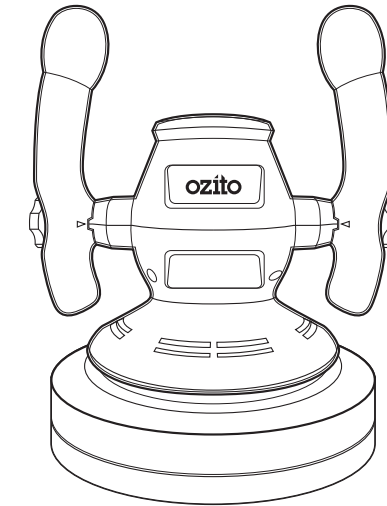

Danger! - Read the operating instructions to reduce the risk of injury



Caution! Wear ear-muffs. The impact of noise can cause damage to hearing.



Caution! Wear a breathing mask. Dust which is injurious to health can be generated when working on wood and other materials. Never use the device to work on any materials containing asbestos!



Caution! Wear safety goggles. Sparks generated during working or splinters, chips and dust emitted by the device can cause loss of sight.

The reprinting or reproduction by any other means, in whole or in part, of documentation and papers accompanying products is permitted only with the express consent of the iSC GmbH.

Subject to technical changes

Items supplied

Please check that the article is complete as specified in the scope of delivery. If parts are missing, please contact our service center or the sales outlet where you made your purchase at the latest within 5 working days after purchasing the product and upon presentation of a valid bill of purchase. Also, refer to the warranty table in the service information at the end of the operating instructions.

- Open the packaging and take out the equipment with care.
- Remove the packaging material and any packaging and/or transportation braces (if available).
- Check to see if all items are supplied.
- Inspect the equipment and accessories for transport damage.
- If possible, please keep the packaging until the end of the guarantee period.

Danger!

The equipment and packaging material are not toys. Do not let children play with plastic bags, foils or small parts. There is a danger of swallowing or suffocating!

Proper use

The equipment is designed solely for waxing/polishing and dewaxing paintwork on motor vehicles, boats, caravans or mobile homes.

The equipment is to be used only for its prescribed purpose. Any other use is deemed to be a case of misuse. The user / operator and not the manufacturer will be liable for any damage or injuries of any kind caused as a result of this.

Please note that our equipment has not been designed for use in commercial, trade or industrial applications. Our warranty will be voided if the machine is used in commercial, trade or industrial businesses or for equivalent purposes.

Technical data

Mains voltage:.....230V ~ 50Hz
Power rating: 110 W
Vibrations:3200/min
Pad diameter:.....Ø 240 mm
Protection class: II/□

Sound and vibration

Sound and vibration values were measured in accordance with EN 60745.

L_{pA} sound pressure level 66 dB(A)
 K_{pA} uncertainty 3 dB
 L_{WA} sound power level 77 dB(A)
 K_{WA} uncertainty 3 dB

Wear ear-muffs.

The impact of noise can cause damage to hearing.

Total vibration values (vector sum of three directions) determined in accordance with EN 60745.

Vibration emission value $a_h = 7.59 \text{ m/s}^2$
K uncertainty = 1.5 m/s^2

The specified vibration value was established in accordance with a standardized testing method. It may change according to how the electric equipment is used and may exceed the specified value in exceptional circumstances.

The specified vibration value can be used to compare the equipment with other electric power tools.

The specified vibration value can be used for initial assessment of a harmful effect.

Keep the noise emissions and vibrations to a minimum.

- Only use appliances which are in perfect working order.
- Service and clean the appliance regularly.
- Adapt your working style to suit the appliance.
- Do not overload the appliance.
- Have the appliance serviced whenever necessary.
- Switch the appliance off when it is not in use.
- Wear protective gloves.

Caution!

Residual risks

Even if you use this electric power tool in accordance with instructions, certain residual risks cannot be ruled out. The following hazards may arise in connection with the equipment's construction and layout:

1. Lung damage if no suitable protective dust mask is used.
2. Damage to hearing if no suitable ear protection is used.
3. Health damage caused by hand-arm vibrations if the equipment is used over a prolonged period or is not properly guided and maintained.



For EU countries only

Never place any electric power tools in your household refuse.

To comply with European Directive 2012/19/EC concerning old electric and electronic equipment and its implementation in national laws, old electric power tools have to be separated from other waste and disposed of in an environment-friendly fashion, e.g. by taking to a recycling depot.

Recycling alternative to the return request:

As an alternative to returning the equipment to the manufacturer, the owner of the electrical equipment must make sure that the equipment is properly disposed of if he no longer wants to keep the equipment. The old equipment can be returned to a suitable collection point that will dispose of the equipment in accordance with the national recycling and waste disposal regulations. This does not apply to any accessories or aids without electrical components supplied with the old equipment.