

5192701335



**User manual**  
**Bedienungsanleitung**  
**Mode d'emploi**  
**Handleiding**  
**Manuale**  
**Manual del usuario**  
**Használati utasítás**  
**Instrukcja obsługi**



**LUTEC** 

**Incl.**

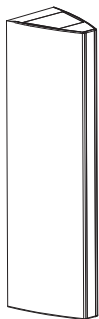

x 2



x 2



x 1

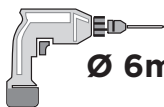

**Ø 6mm**



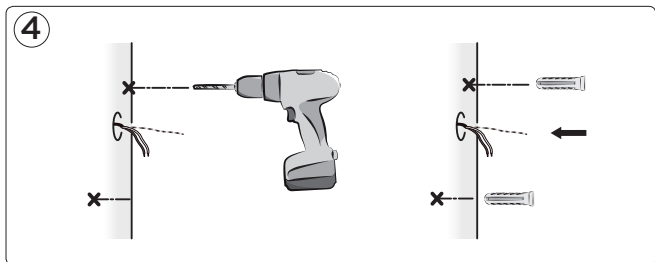
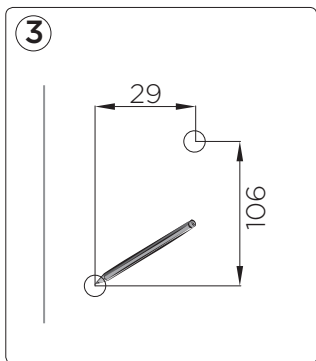
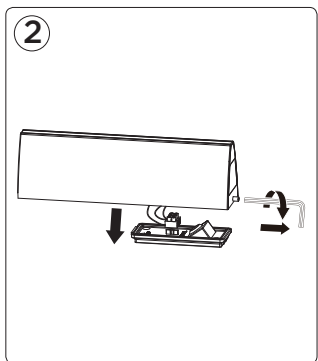
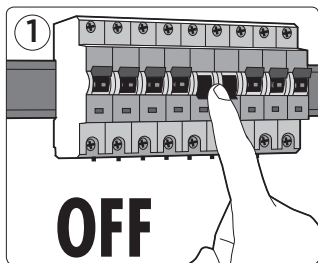

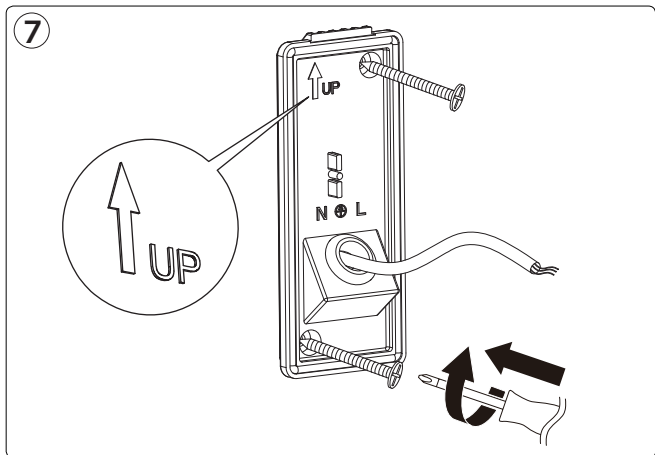
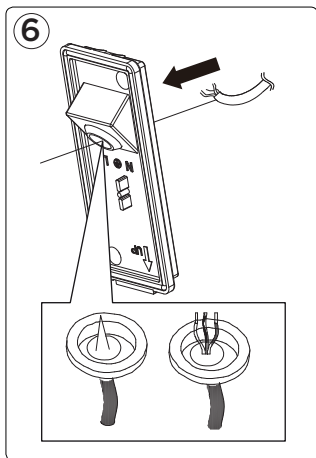
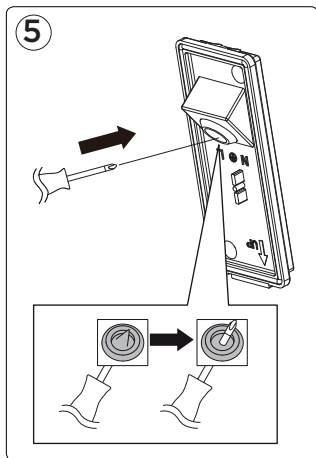

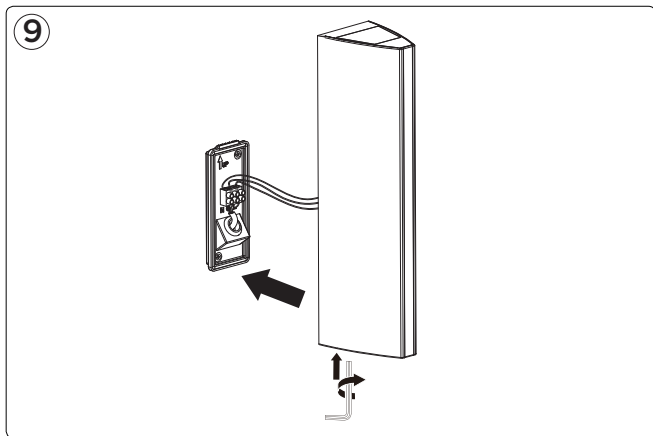
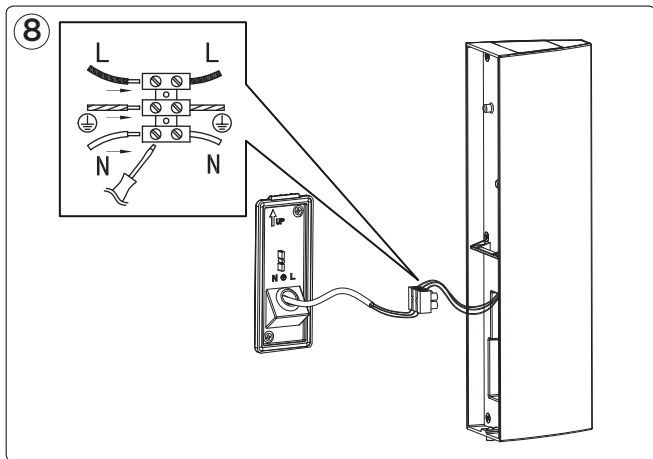



## **LUTEC Europe NV**

Herentalsebaan 425  
B-2160 Wommelgem - Belgium  
+32 3 284 51 62  
info@lutec-europe.com  
www.lutec.com



[www.lutec.com/services/global-network](http://www.lutec.com/services/global-network)