

THANK YOU FOR BUYING A HOTPOINT PRODUCT.

In order to receive a more complete assistance, please register your appliance on www.hotpoint.eu/register

Before using the appliance carefully read the Safety Instruction.



Before using the machine, it is imperative that the transport bolts are removed. For more detailed instructions on how to remove them, see the Installation Guide.

CONTROL PANEL

- 1 "ON/OFF" button
- 2 Programme selector
- 3 "Start/Pause" button
- 4 "Spin Speed" button
- 5 "Multi Rinse" button
- 6 "Cleaning Action" button
- 7 "Start Delay" button
- 8 "Energy saver" / "Key lock" button
- 9 "Temperature" button

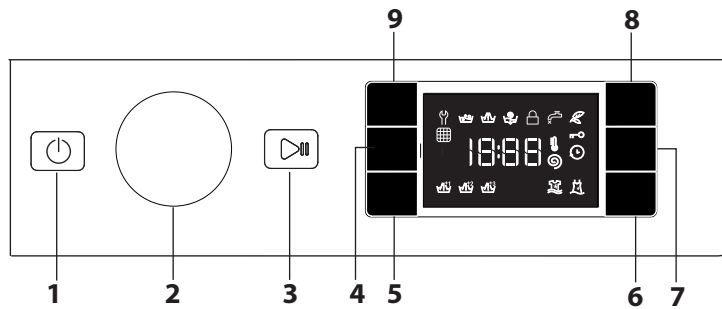

DISPLAY INDICATORS

Door locked

Energy saver activated

Start Delay activated

Key lock activated

Washing phase

Indicates washing phase of the cycle

Failure: Call Service

Refer to Troubleshooting section

Failure: Water filter clogged

Water cannot be drained; water filter might be blocked

Failure: No water

No or not sufficient inlet water.

In the event of any failure, refer to the "TROUBLESHOOTING" section

PROGRAMME CHART

Maximum load 7 kg Power input in off mode 0.5 W / in left-on mode 8 W						Detergents and Additives		Recommended detergent		Residual dampness %	Energy consumption kWh	Total water l	
Wash cycle	Temperature		Maximum spin (r.p.m.)	Maximum load (kg)	Duration (minutes)	Wash	Fabric softener	Powder	Liquid				
	Default	Range				1	2						
1	Anti Stain 100	40 °C	☼ -40 °C	1400	7,0	**	●	○	✓	-	-	-	
2	Anti Stain Quick	40 °C	☼ -40 °C	1200	3,5	**	●	○	-	✓	-	-	
3	White	60 °C	☼ -90 °C	1400	7,0	**	●	○	✓	-	-	-	
4	Bed Linen	60 °C	☼ -60 °C	1400	7,0	**	●	○	✓	-	-	-	
5	Eco Cotton (1)	60 °C	60 °C	1400	7,0	270	●	○	✓	✓	53	0,82	52,5
		40 °C	40 °C	1400	7,0	220	●	○	✓	✓	53	0,97	75
6	Mixed	40 °C	☼ -40 °C	1000	3,5	**	●	○	-	✓	-	-	
7	Cotton (2)	40 °C	☼ -60 °C	1400	7,0	220	●	○	✓	-	53	0,97	75
8	Synthetics (3)	40 °C	☼ -60 °C	1200	4,0	195	●	○	✓	-	33	0,75	72
9	Coloureds	40 °C	☼ -40 °C	1400	7,0	**	●	○	✓	-	-	-	
10	Fast 30 min	30 °C	☼ -30 °C	800	3,0	30	●	○	-	✓	71	0,19	29
11	Wool	40 °C	☼ -40 °C	800	1,5	**	●	○	-	✓	-	-	
12	Dark	30 °C	☼ -30 °C	800	4,0	**	●	○	-	✓	-	-	
13	Ultradelicates	30 °C	☼ -30 °C	0	1,0	**	●	○	-	✓	-	-	
14	Duvet	30 °C	☼ -30 °C	1000	2,0	**	●	○	-	✓	-	-	
	Rinse + Spin	-	-	1400	7,0	**	-	○	-	-	-	-	
	Spin + Drain *	-	-	1400	7,0	**	-	-	-	-	-	-	

● Required dosage ○ Optional dosage

The cycle duration indicated on the display or instruction manual is an estimate based on standard conditions. The actual duration may vary in relation to several factors, such as the temperature and pressure of the incoming water, ambient temperature, amount of detergent, load quantity and type, load balancing and any additional options selected.

1) Test wash cycle in compliance with regulation 1061/2010:

This cycle is designed for normally soiled cotton loads and is the most efficient in terms of both electricity and water consumption; it should be used for garments washable at 60°C or at 40°C. The actual washing temperature may differ from the indicated value.

For all testing institutes:

- 2) Long cotton cycle: set cycle 7 at a temperature of 40°C.
- 3) Long synthetics cycle: set cycle 8 at a temperature of 40°C.

* By selecting the cycle and excluding the spin cycle, the washing machine will drain only.

** The duration of the wash cycles can be checked on the display.

PRODUCT DESCRIPTION

- 1. Worktop
- 2. Detergent dispenser
- 3. Control panel
- 4. Door handle
- 5. Door
- 6. Water filter
- 7. Adjustable feet (4)

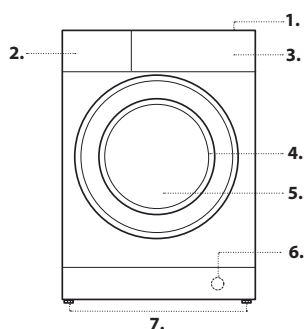

DETERGENT DISPENSER

Compartment *:

Do not insert detergent in this compartment.

Compartment 1: Washing detergent (powder or liquid)

Compartment 2: Additives (fabric softeners, etc.)

The fabric softener must not exceed the "MAX" level.

! Use powder detergent for white cotton garments, for pre-washing, and for washing at temperatures over 60°C.

! Follow the instructions given on the detergent packaging.

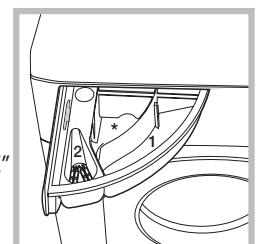

PROGRAMMES

Follow the instructions on the symbols of the garment's wash care label. The value indicated in the symbol is the maximum recommended temperature for washing the garment.



Anti Stain 100

This cycle is suitable to heavily-soiled garments with resistant colours. It ensures a washing class that is higher than the standard class (A class). When running the programme, do not mix garments of different colours. We recommend the use of powder detergent. Pre-treatment with special additives is recommended if there are obstinate stains

Anti Stain Quick

This cycle is ideal for washing daily stains in 45'. It is ideal for mixed fabrics and coloured garments.

White

For heavily soiled whites and resistant colours.

Bed Linen

For washing home linen in a single cycle. It optimises the use of fabric softener and allows for saving time and electricity. We recommend the use of powder detergent.

Eco Cotton

Suitable for washing moderately soiled cotton garments. At 40°C and 60°C it is the standard cycle for washing cotton garments, and is the most efficient in terms of combined water and electricity consumption.

Mixed

To wash mixed and coloured items together.

Cotton

Suitable for washing towels, underwear, table cloths, etc. made of resistant linen and cotton that are moderately to heavily soiled.

Synthetics

Suitable for washing moderately soiled garments made of synthetic fibres (e.g. polyester, polyacrylic, viscose, etc.) or mixed synthetic-cotton fibres.

Coloureds

For washing coloured cotton garments. This programme is optimised to keep colours bright even after repeated washing.

Fast 30 min

For washing lightly soiled garments in a short time. Not suitable for wool, silk and garments to be washed by hand.

Wool - Woolmark Apparel Care - Green:

The Wool wash cycle of this machine has been approved by The Woolmark Company for the washing of wool garments labelled as "hand wash" provided that the products are washed according to the instructions on the garment label and those issued by the manufacturer of this washing machine (M1126). The Woolmark logo is a Certification mark in many countries.



Dark

For washing dark-coloured garments. The wash cycle is designed to preserve dark colours over time.

We recommend using a liquid detergent for best results, preferably when washing dark-coloured garments.

Ultradelicates

For washing very delicate garments. It is advisable to turn the garments inside out before washing them. For best results, use liquid detergent on delicate garments.

Duvet

Suitable for washing clothing padded with goose down, such as single duvets (weighing under 2 kg), cushions or down jackets. Duvets should be loaded into the drum with their edges folded inwards and no more than 3/4 of the total drum volume should be used up. For best results, it is advisable to use liquid detergent to be poured into the detergent drawer.

Rinse + Spin

Designed for rinsing and spinning.

Spin + Drain

Designed for spinning and draining the water.

FIRST TIME USE

To remove any manufacturing debris select the **3** programme at a temperature of 90°C. Pour a small quantity of detergent powder into the main wash **2** compartment of the detergent dispenser (maximum 1/3 of the quantity the detergent manufacturer recommends for lightly soiled laundry). Start the programme **without adding any laundry**.

DAILY USE

Prepare your laundry according to the recommendations in the "HINTS AND TIPS" section. Load the laundry, close the door, open the water tap and press the "ON/OFF" button to switch the washing machine on, the "Start/Pause" button flashes. Turn the programme selector to the desired programme and select any option if needed. The temperature and spin speed can be changed by pressing the "Temp." button or the "Spin Speed" button. Pull out the detergent dispenser and add the detergent (and additives/softener) now. Observe the dosing recommendations on the detergent pack. Then close the detergent dispenser and press the "Start/Pause" button. The "Start/Pause" button will lights up and the door will be locked.

PAUSE A RUNNING PROGRAMME

To pause the wash cycle, press the "Start/Pause" button; the indicator light will go off and the remaining time on display flash. To start the wash cycle from the point at which it was interrupted press the button again.

OPEN THE DOOR, IF REQUIRED

After starting a programme, the "Door locked" indicator lights up to show that the door can not be opened. As long as a wash programme is running, the door remains locked. To open the door while a programme is in progress, press the "Start/Pause" button to pause the programme. Provided the water level and/or temperature is/are not too high, the "Door locked" indicator light goes off and you can open the door. For example to add or remove laundry. Press the "Start/Pause" button again to continue the programme.

PROGRAMME END

The "Door locked" indicator light goes off and the display shows "End". To switch off the washing machine after programme ends press the "ON/OFF" button, the lights goes off. If you do not press "ON/OFF" button, the washing machine will switch off automatically after about a half of an hour. Close the water tap, open the door and unload the washing machine. Leave the door ajar to allow the drum to dry.

OPTIONS

! If the selected option is incompatible with the programme set, the incompatibility will be signalled by a buzzer (3 beeps) and the corresponding indicator light will flash.

! If the selected option is incompatible with another previously set option, only the most recent selection will remain active.

Energy saver

This option saves energy by not heating the water used to wash your laundry – an advantage both to the environment and to your energy bill. Instead, intensified wash action and water optimisation ensure great wash results in the same average time of a standard cycle. For the best washing results we recommend the usage of a liquid detergent.

Start Delay

To set the selected programme to start at a later time, press the button to set the desired delay time. Symbol lights on the display when this function is enabled. To cancel the delayed start, press the button again until the value, "0" is shown on the display.

Multi Rinse

By selecting this option, the efficiency of the rinse is increased and optimal detergent removal is guaranteed. It is particularly useful for sensitive skin. Press the button once, two or three times to select an additional 1, 2 or 3 rinses after the standard cycle rinse and remove all traces of detergent. Press the button again to go back to the "Normal rinse" rinse type.

Cleaning Action

Option "Cleaning Action" makes it possible to optimise washing based on the level of soil in the fabrics and on desired wash cycle intensity. For heavily-soiled garments press "Cleaning Action" button until the "level" is reached. This level ensures a high-performance wash due to a larger quantity of water used in the initial phase of the cycle and due to increased drum rotation. It is useful when removing the most stubborn stains. For lightly-soiled garments or a more delicate treatment of the fabrics, press "Cleaning Action" button until the "level" is reached. The cycle will reduce drum rotation to ensure washing results that are perfect for delicate garments.



Temperature

Every programme has a predefined temperature. If you want to change the temperature, press the "Temp." button. The value appears on the display.

Spin Speed

Every programme has a predefined spin speed. If you want to change the spin speed, press the "Spin Speed" button. The value appears on the display.

KEY LOCK

To lock the control panel, press and hold the “Energy saver” button for approximately 3 seconds. The symbol  will light up on the display to indicate that the control panel has been locked (with the exception of the “ON/OFF”  button). This prevents unintentional changes to programmes, especially with children near the machine. To unlock the control panel, press and hold the “Energy saver” button for approximately 3 seconds.

HINTS AND TIPS

Sort your laundry according to

Type of fabric/care label (cotton, mixed fibres, synthetics, wool, handwash items). Colour (separate coloured and white items, wash new coloured items separately). Delicates (wash small items – like nylon stockings – and items with hooks – like bras – in a cloth bag or pillow case with zip).

Empty all pockets

Objects like coins or lighters can damage your laundry as well as the drum.

CLEANING & MAINTENANCE

For any cleaning and maintenance, switch off and unplug the washing machine. Do not use flammable fluids to clean the washing machine.

Cleaning the outside of the washing machine

Use a soft damp cloth to clean the outer parts of the washing machine. Do not use glass or general purpose cleaners, scouring powder or similar to clean the control panel – these substances might damage the printing.

Checking the water supply hose

Check the inlet hose regularly for brittleness and cracks. If damaged, replace it by a new hose available through our After-Sales Service or your specialist dealer. Depending on the hose type: If the inlet hose has a transparent coating, periodically check if the colour intensifies locally. If yes, the hose may have a leak and should be replaced

Cleaning the mesh filters in the water supply hose

Close the tap and loosen the inlet hose on the tap. Clean the internal mesh filter and screw the water inlet hose back onto the tap. Now unscrew the inlet hose on the rear of the washing machine. Pull off the mesh filter from the washing machine connection with universal pliers and clean it. Refit the mesh filter and screw the inlet hose on again. Turn on the tap and ensure that the connections are completely water-tight.

Cleaning the water filter / draining residual water

If you used a hot wash programme, wait until the water has cooled down before draining any water. Clean the water filter regularly, to avoid that the water cannot drain after the wash due to obstruction of the filter. If the water cannot drain, the display indicates that the water filter may be clogged.

Place a broad, flat container beneath the water filter, to collect the drain water. Slowly turn the filter counterclockwise until water flows out. Let the water flow out, without removing the filter. When the container is full, close the water filter by turning it in clockwise. Empty the container. Repeat this procedure until all the water has drained. Lay a cotton cloth beneath the water filter, which can absorb a small amount of rest water. Then remove the water filter by turning it out anti clockwise. Clean the water filter: remove residues in the filter and clean it under running water. Reinsert the water filter again by turning it in clockwise direction. Make sure to turn it in as far as it goes; the filter handle must be in vertical position. To test water tightness of the water filter, you can pour about 1 liter of water into the detergent dispenser.



TRANSPORT AND HANDLING

Never lift the washing machine by holding it at the worktop.

Pull out the mains plug, and close the water tap. Make sure that door and detergent dispenser are properly closed. Disconnect the inlet hose from the water tap, and remove the drain hose from your draining point. Remove all rest water from the hoses, and fix them so that they cannot get damaged during transport. Refit the transport bolts. Follow the instructions for removing the transport bolts in the Installation Guide in reverse order.

TROUBLESHOOTING

The washing machine may sometimes not work properly for certain reasons. Before calling the After-sales service, it is recommended to check to see if the problem can be easily resolved using the following list.

Anomalies:	Possible causes / Solution:
The washing machine does not turn on.	<ul style="list-style-type: none"> The plug is not inserted into the electrical outlet, or not enough to make contact. There has been a power failure.
The wash cycle does not start.	<ul style="list-style-type: none"> The door is not fully closed. The "ON/OFF"  button has not been pressed. The "Start/Pause"  button has not been pressed. The water tap is not open. A "Start Delay" has been set.
The washing machine does not fill with water (the message "h2o" is shown on the display).	<ul style="list-style-type: none"> The water intake hose is not connected to the tap. The hose is bent. The water tap is not open. The mains water supply has been shut off. There is not enough pressure. The "Start/Pause"  button has not been pressed.
The washing machine loads and drains water continuously.	<ul style="list-style-type: none"> The drain hose has not been installed at 65 to 100 cm from the ground. The end of the drain hose is immersed in water. The drain connector on the wall does not have an air vent. If the problem persists after having performed these checks, close the water tap, shut off the washing machine, and call the After-sales service. If the dwelling is located on one of the uppermost floors of a building, a siphon effect can sometimes occur, thus causing the washing machine to load and drain water continuously. Special anti-siphon valves are available on the market to prevent these types of problems.
The washing machine does not drain or does not spin.	<ul style="list-style-type: none"> The programme does not include the draining function: with certain programmes it must be activated manually. The drain hose is bent. The drain line is obstructed.
The washing machine vibrates excessively during the spin cycle.	<ul style="list-style-type: none"> At the time of installation, the drum was not properly unblocked. The washing machine is not level. The washing machine is squeezed between furniture and the wall.
The washing machine leaks water.	<ul style="list-style-type: none"> The water intake hose has not been tightened properly. The detergent dispenser is clogged. The drain hose has not been properly fastened.
The machine is locked and the display flashes, indicating an error code (e.g. F-01, F-..).	<ul style="list-style-type: none"> Shut off the machine, disconnect the plug from the outlet, and wait about 1 minute before turning it back on. If the problem persists, call the After-sales service.
Too much foam is formed.	<ul style="list-style-type: none"> The detergent is not compatible with the washing machine (it must bear the wording "for washing machines", "for hand washing and washing machines", or something similar). The dosage was excessive.
Door is locked, with or without failure indication, and the programme does not run.	<ul style="list-style-type: none"> Door is locked in case of power breakdown. Programme will continue automatically as soon as the mains is available again. Washing machine is in a standstill. Programme will continue automatically after the origin of the standstill does not persist anymore.

DEMO MODE: to deactivate this function, switch the washing machine OFF. Then press and hold "Start/Pause"  button, within 5 seconds press also "ON/OFF"  button and hold both buttons for 2 seconds.



You can download the **SAFETY AND INSTALLATION INSTRUCTIONS, OPERATING MANUAL, TECHNICAL SHEET and ENERGY DATA** by:

- Visiting the website <http://docs.hotpoint.eu>.
- Using the QR code.
- Alternatively, **contact our Technical Assistance Service** (the telephone number is indicated in the warranty booklet). When contacting the Technical Assistance Service, provide the codes shown on the adhesive label applied to the inside of the door.

