

**HARDWARE SUPPLIED**

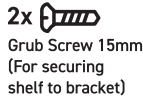
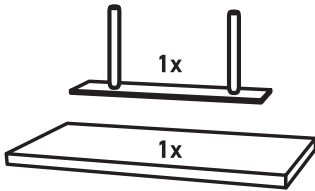

**A MASONRY WALL INSTALLATION**

6x  
Masonry Plug

---

**B PLASTERBOARD WALL INSTALLATION**

6x  
Plasterboard Plug

**TOOLS REQUIRED**

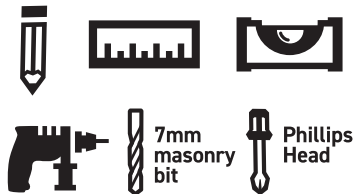

**CAPACITY**

Weight load capacity can vary based on the type of wall you're affixing the shelf to. As a guideline please see below:



\*LOAD EVENLY DISTRIBUTED

**flexi**<sup>TM</sup>  
**TIP**

**READ THROUGH INSTRUCTIONS BEFORE COMMENCING INSTALLATION**

Screws and fixings for both masonry and stud walls are included.  
TIP Use only the 6 holes in the bracket that best suit your fixing application.

**STEP 1**

Please read through Fixing Hints prior to commencing Steps.  
Position bracket at desired height against the wall, and using a pencil, mark the 6 holes  
**Note:** • Make sure the arrow on the bracket points up.  
• Use spirit level to ensure bracket is level.  
(See Diagram 1)

**DIAGRAM 1**

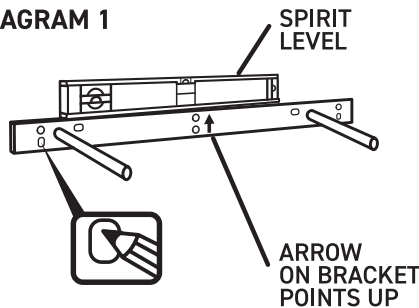

**STEP 2**

**A (Masonry)** Using a 7mm masonry drill bit. Drill a 40mm deep hole. Tap Wall Plug into hole (a light hammer may be required) until flush with wall surface. Position Bracket over installed Masonry Plug and install Masonry Plug Screw into wall plug.  
**B (Plasterboard)** Using a Phillips head screwdriver, use force to thread plug through Plasterboard Wall until it is flush with the surface of the wall. Position Bracket over installed Plasterboard Plug and install Plasterboard Plug Screw into wall plug.

**Note:** Refer to Fixing Hints for additional installation information.  
When installing into timber walls or directly into studs, you can install without the need for Plasterboard or Masonry plugs. We suggest pre-drilling a small hole first for easier fixing.

**DIAGRAM 2**

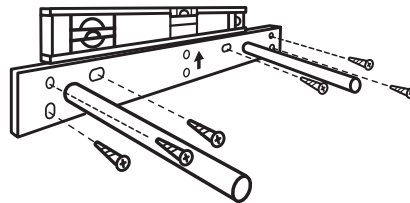

**DIAGRAM 3A**

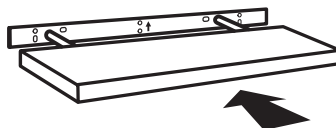

**DIAGRAM 3B**

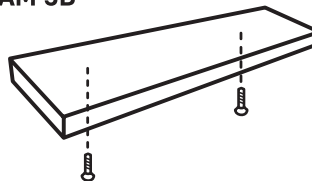

**STEP 3**

Slide the shelf onto the 2 tubes on the bracket.  
**Note:**  
• The 2 holes on the shelf face are to point down. (See Diagram 3A)  
• Fix the shelf to the bracket by fitting the 2 countersunk head screws from underneath.  
• Don't over-tighten (See Diagram 3B).  
• Add stickers over screw holes.

**FIXING HINTS:**

1. When mounting onto a plasterboard wall if possible mountings should be into at least 1 stud for added security. If holes do not align with stud, an extra hole could be drilled through the bracket to accommodate this.
2. If mounting only into a plasterboard wall then spread the anchors apart. Try to use only one (upper or lower) of the twin holes as securing using at both of twin holes can weaken plaster.
3. Note that when mounting into plasterboard wall, the anchors are only as strong as the wall they are mounted into. This could reduce the load capacity.

**NOTE:**

For safety, the bracket pipes are angled slightly upward to prevent shelf droop when shelf is loaded to capacity.  
Please note that Floating Shelves are designed for displaying infrequently used decorative items only.  
Please keep gloss shelves from direct sunlight as UV light can cause discolouration.

**HOW TO USE A  
PLASTERBOARD PLUG:**

1. Place Plasterboard Plug on the end of a screwdriver.

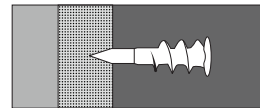

2. Lightly pierce plasterboard where the anchor is to be installed using point of Plasterboard Plug. Use firm pressure and screw Plasterboard Plug into the plasterboard until the flat head is tight and flush against the plasterboard.

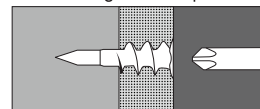

3. Attach item to be fixed to the wall by driving the Plasterboard Plug Screw into the Plasterboard Plug.

