

WL600722H
WL600822H
WL600922H
WL6018**H
WL601915H
WL601931H
WL6022**H



Please read the information sheet before proceeding.

WHAT TO KNOW BEFORE INSTALLING...

1. When positioning the seat onto the pan ensure that the lid and ring can be lifted and remain upright on the pan. In some cases the seat can be obstructed by the cistern or the flush handle which prevents it from staying upright.
2. Before activating the grip pad technology (Step 8) ensure the toilet seat is in a perfect position as it cannot be reused without compromising performance.
3. To remove the seat at the end of its use, use a scraper to carefully lever the hinge away from the toilet pan.

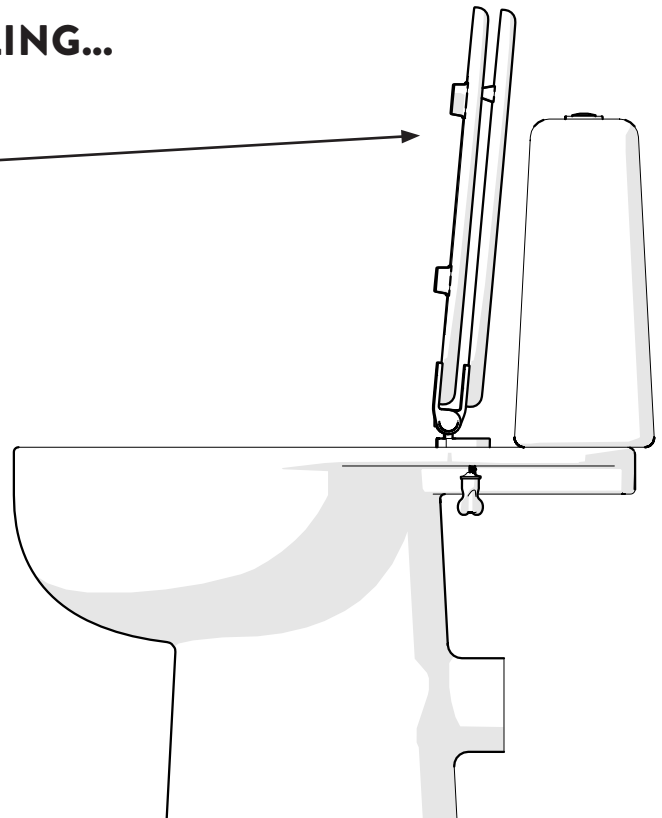

Croydex, Central Way, Andover,
Hampshire, SP10 5AW, UK



+44 (0) 1264 365881



+44 (0) 1264 356437



info@croydex.co.uk



www.croydex.com

TS 045 R02



For reference only



Parts may vary.
(Optional)



Warning! Please
take special care.

PLEASE READ ALL OF THE INFORMATION CAREFULLY AND REFER BACK WHEN YOU SEE THE NUMBERED ICONS THROUGHOUT INSTRUCTIONS.

SAFETY AND CARE (EN)

- 1 To retain the best quality finish, clean product with a soft cloth and a mild soap solution.
- 2 Do not use abrasive or chemical cleaners as they may damage the surface of the toilet seat or hinges.
- 3 Spray cleaning liquids onto the cloth and not directly onto the product.
- 4 Take care when cleaning the toilet pan with chemical cleaners. Avoid contact of the chemical cleaners with the toilet seat or hinges. Immediately rinse off any splashes to avoid damage or discolouration to the surface of the toilet seat and hinge parts.

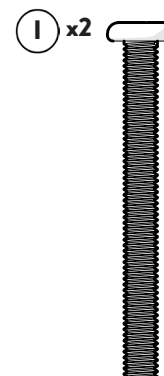
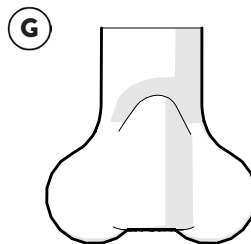
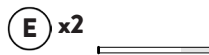
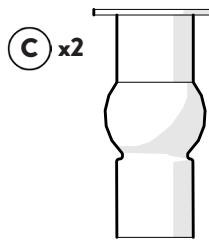
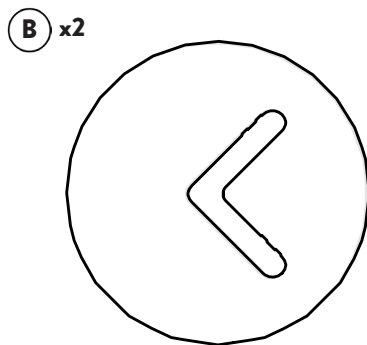
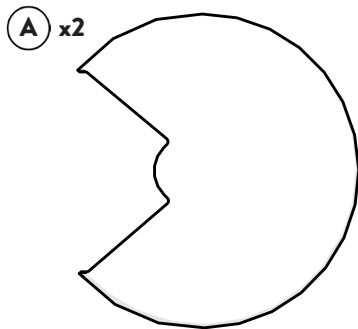

1. BEFORE YOU BEGIN

PREPARATION

- Remove the old seat from the pan and clean the surface around the fixing holes.
- Ensure the surfaces around the fixing holes are completely dry before beginning the installation.

PLACEMENT

In its sealed packaging place the seat over your pan to ensure you are happy with size and shape of the toilet seat.

HELPFUL ADVICE

To ensure you do not lose any components down the toilet you may want to place cling film over the bowl of the toilet.

2.

Remove the decorative and protective caps from the hinges.

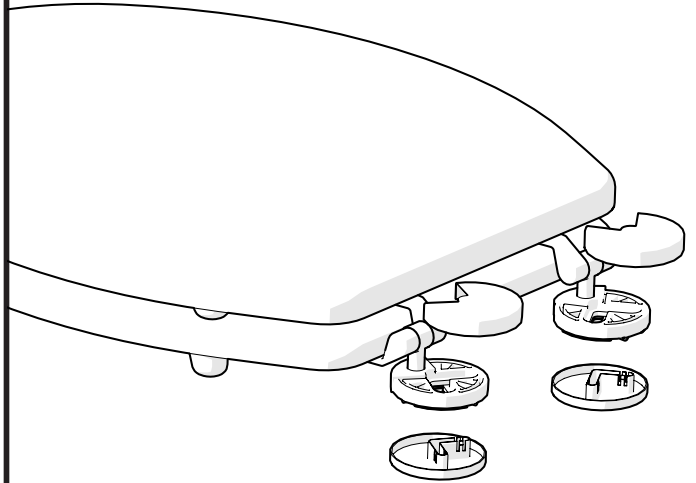

3.

3a.

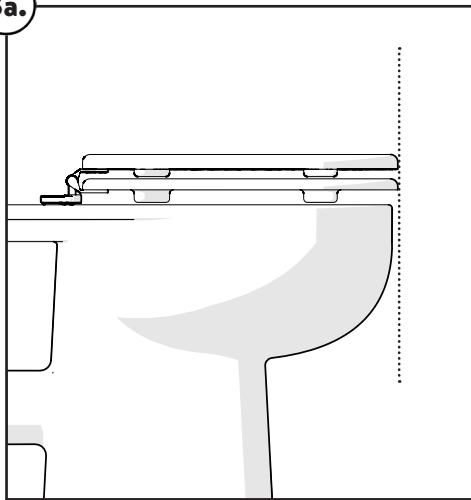

3a. Align the seat with the front of the toilet pan.

3b. Choose the slot which best suits the position of the toilet seat on your toilet pan.

3b.

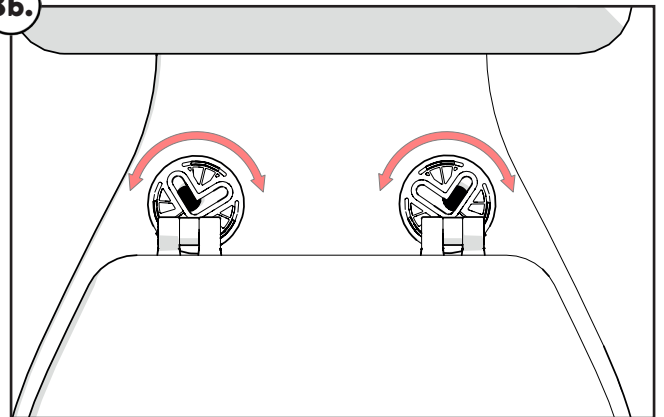

3b.

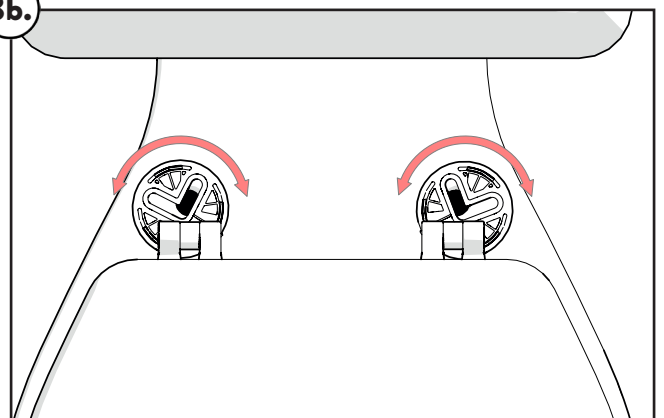

*Hinge positions should be symmetrical.

3.

 Croydex, Central Way, Andover, Hampshire, SP10 5AW, UK

 +44 (0) 1264 365881

 +44 (0) 1264 356437

 info@croydex.co.uk

 www.croydex.com

TS 045 R02

4.

Remove the protective film to reveal the grip pad and place bolts into the hinge base.

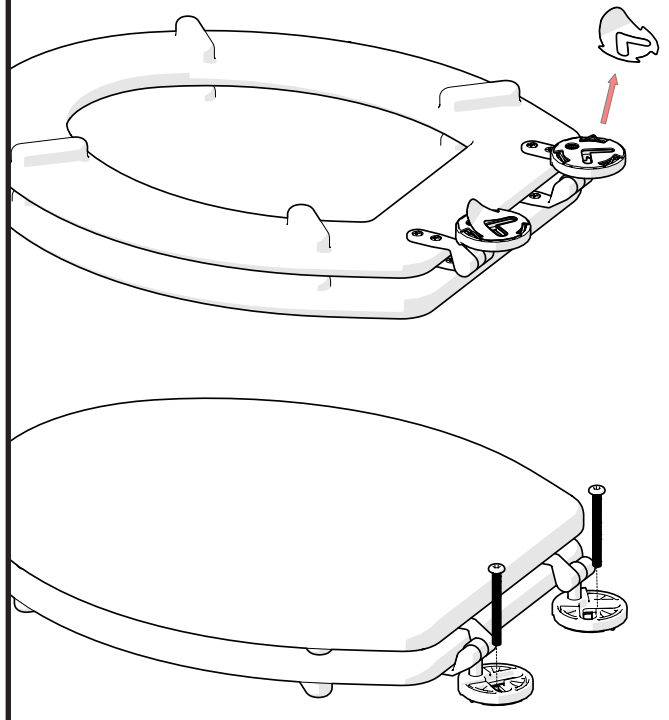

5.

TOP OR BOTTOM FIXINGS?

TOP FIX

- Fits most toilet pans.
- Suitable for back to wall pans.
- No need to reach underneath the toilet pan.

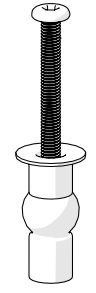

OR

BOTTOM FIX

- Faster installation.

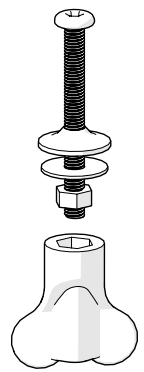

6.

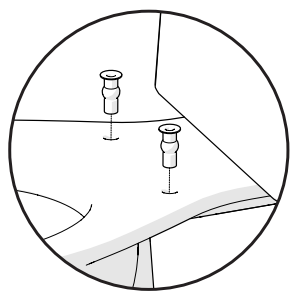

For top fix, insert the rubber plugs into the holes in the toilet pan.



Carefully place the seat on the pan ensuring the Grip Pad does not stick to the pan surface at this stage of installation.

7.

Lightly screw the bolt into place using your chosen fixing method. Do not collapse the supports on the hinge base yet.

BOTTOM FIX

TOP FIX

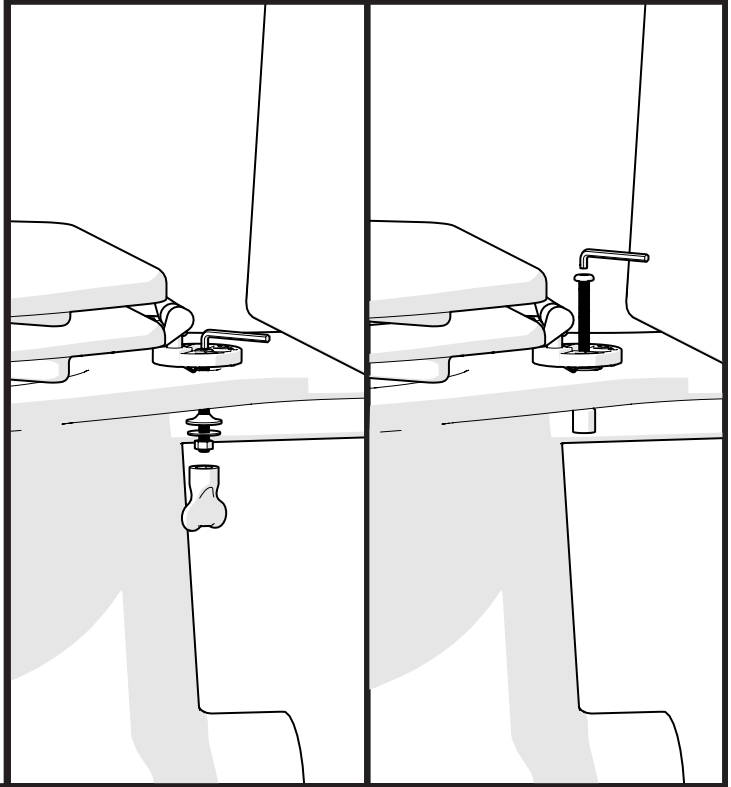

4.

Croydex, Central Way, Andover, Hampshire, SP10 5AW, UK

+44 (0) 1264 365881

+44 (0) 1264 356437

info@croydex.co.uk

www.croydex.com

TS 045 R02

8. Complete a final check to ensure that you are happy with the position of the seat. During the final check ensure hinges are fully inserted into the seat.

Then apply pressure to the hinges to collapse the supports allowing the grip pad to bond to the toilet pan. **Hold for at least 20 seconds.**

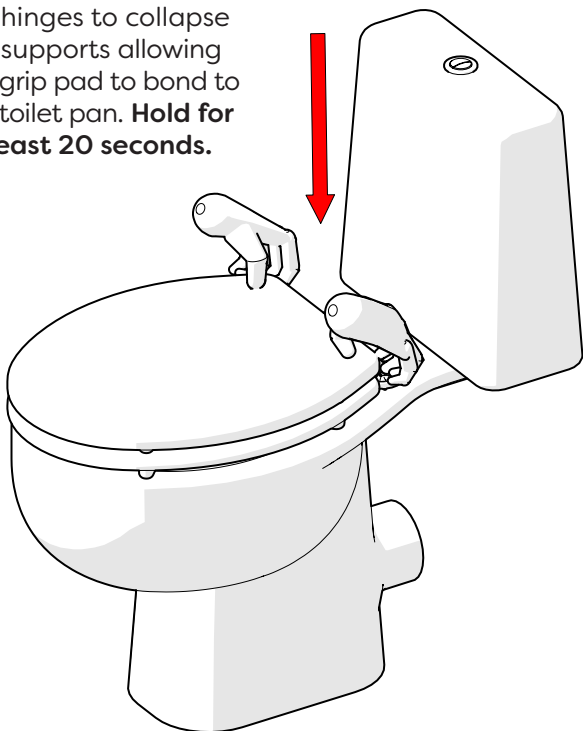

9. **Fully tighten** the bolt using your preferred fixing method.

BOTTOM FIX

TOP FIX

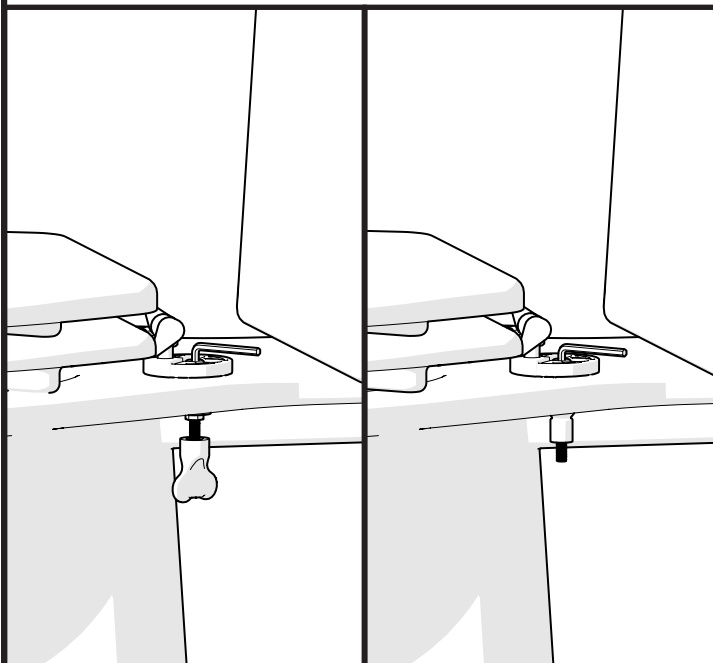

If you need to lift the seat to access the bolt, ensure you do not move the hinges.

10. Place on the decorative covers.

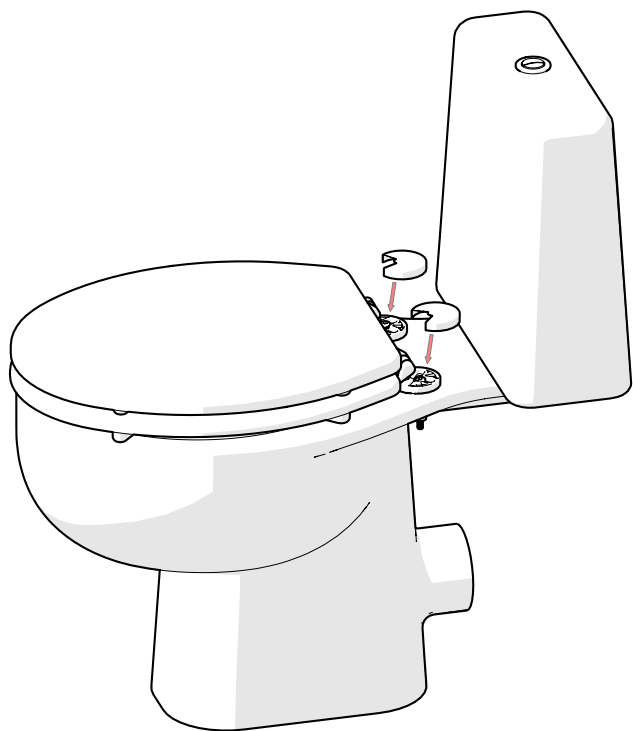

5.

 Croydex, Central Way, Andover, Hampshire, SP10 5AW, UK

 +44 (0) 1264 365881

 +44 (0) 1264 356437

 info@croydex.co.uk

 www.croydex.com

TS 045 R02