

Installation Instructions (UK)

Includes aftercare & guarantee details







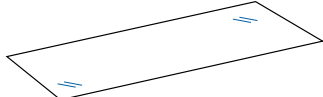

High Gloss Acrylic Panel

Note: The optional, dedicated fitting kit is highly recommended in order to ensure the correct products are used for installation

Parts Supplied

Description		Qty
High Gloss Acrylic Panel		1

Parts Required for Installation

	Description	Qty	Included in Installation Kit
	Neutral Cure Low modulus Silicone 310ml	1 tube per wide panel	YES
	15mm x 1.5mm thick double coated polyethylene foam tape with synthetic rubber adhesive	Approx. 16m	YES
	120 grit sanding pad/ emery paper	1	YES
	240 grit sanding pad/ emery paper	1	YES
	3mm tile spacers	3 per panel	YES
	Leveling wedges	3 per panel	YES
	Soft Flexible Silicone Spatula	1	YES
	Nylon Protection Gloves	1 Pair	YES

Introduction





A superior high gloss acrylic panel featuring a high performance hard-coated surface.

Ideal for heavy-duty vertical applications. Especially suited for shower walls, bathroom partitions and kitchen splashbacks in both residential and commercial applications. Completely inert. Will not release any emissions to the environment. Non-stick outer surface does not harbour mould or calcium build-up. Material is ultra hygienic and does not promote bacterial growth or transmission.



Please note the limitations overleaf, especially when using the acrylic panel as a kitchen splashback.

Tools Required for Installation

- Measuring

	x 1	Measuring Tape
	x 1	Soft Pencil or soft tip marker pen
	x 1	Carpenters Square
	x 1	Spirit Level

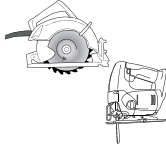
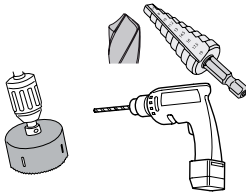
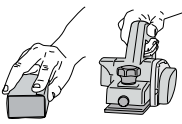
- Cutting

	x 1	Power Saw/ Jigsaw with fine tooth carbide tipped blades
	x 1	Power or battery drill & appropriate drill bits / hole cutters
	x 1	Medium (120) & Fine (240) grit emery paper & sanding block or power planer
	x 1	Personal eye, hearing, hand & footwear protective equipment

- General Installation

	x 1	Silicone caulk gun
--	-----	--------------------

Before You Start

PRIOR TO COMMENCING INSTALLATION PLEASE READ CAREFULLY THE COMPLETE INSTALLATION BOOKLET NOTING ALL WARNINGS AND INSTALLATION GUIDELINES.



Very Important general information about your acrylic panels, please read

- We strongly recommend the use of the dedicated installation kit in order to achieve a professional finish
- If the dedicated installation kit is not used then it is important that a neutral cure silicone is used for the installation to avoid cracking and poor adhesion. Do not use a standard acetic curing silicone
- When used as a kitchen splashback, the panel is not suitable for use behind a gas hob; only ceramic or induction hobs. Also additional protection is recommended directly behind hobs to avoid damage to the panels caused by direct contact with hot pans. Please see Fig.1
- Panels are not to be used directly behind or adjacent to a heat source above 70 deg C. When used behind electric, ceramic or induction hobs a clearance of at least 50mm is required between the edge of the hob and the panel
- Panels will expand and contract with temperature at the rate of 0.7 mm / 1000 mm / 10 deg C so it's very important to allow a 4mm expansion gap at the perimeter of each panel
- When using panels for renovation over existing tiles or other wall finishes, it may be necessary to reposition the taps and outlets to align with the finished surface of the panel (see Fig.2 below)

Fig. 1

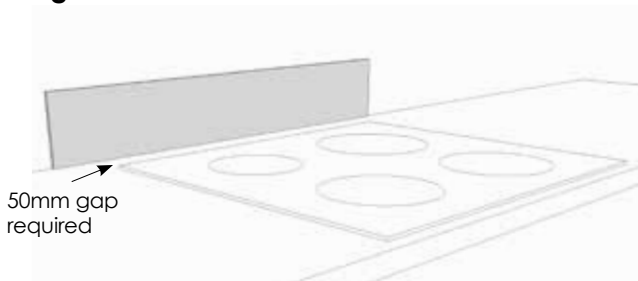
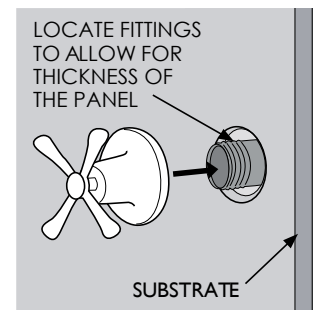

Fig. 2



- Do not store or transport the sheets outdoors or in direct sunlight or in extreme heat
- Sheets must be stored inside, and stacked horizontally to avoid any bowing of the sheet
- We strongly recommend that sheets should only be cut or shaped at room temperature (approx.19°C)
- Sheets may have sharp edges, so always wear gloves and other appropriate clothing and footwear for your protection during the installation process
- Always wear eye protection during the installation of acrylic panels and other safety equipment relative to the installation tools being used
- The surface of the sheets is very hard and scratch resistant. If severe damage does occur and the surface coating is compromised, the panel cannot be refinished and should be replaced
- Before installation check the sheet to ensure no damage has occurred during transport
- Always sand the edges of panels after every cut and drill hole, using 240 grit sanding pad
- We recommend the use of a silicone spatula in order to create a Professional silicone joint

Area Preparation

- Ensure the walls are smooth, clean and dry
- All existing substrate wall panel fixings must be set flush or recessed as illustrated in Fig.3 A, B & C
- For wall lining, use waterproof panelling or plasterboard only in accordance with local building regulations for shower or bath areas
- All substrate wall linings must be sealed at the joints with a generous silicone or waterproofing compound as illustrated in Fig. 4
- For best results, mark out where the joints as illustrated in Fig. 5 are going to be placed and paint the wall surface with a colour similar to the panel colour you intend to install, to ensure consistent colour at the joints which will show beneath the clear silicone

Pantone Colours

For painting the wall behind panel joints we recommend paint colour mixing to match the Pantone numbers below:

- Arctic - Standard White
- Glacier - 621 C
- Blue Atoll - 631 C
- Rouge - 200 C
- Mocha - 408 C
- Titan - Cool Grey 8 C
- Carbon - Black 3 C
- Safari - 7535C
- Forest - 7767C

Fig. 3

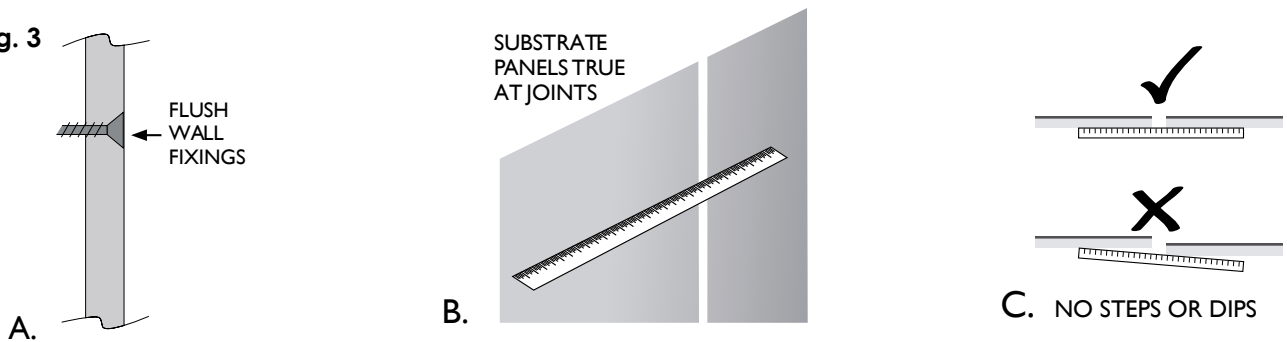

Fig. 4

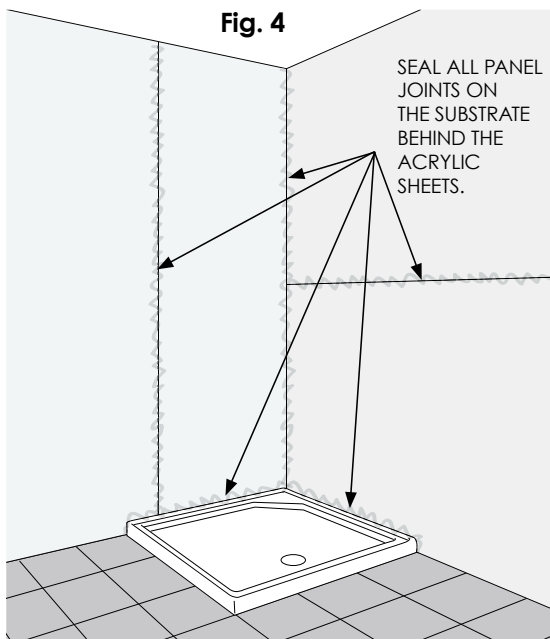

Fig. 5



Tiled Walls

- Acrylic panels can be easily installed over existing tiled walls as long as the tiles are securely attached and thoroughly cleaned before installation.
- Ensure the tiles are free of soap or other build up. Conduct a final clean using a degreaser such as "Sugar Soap" and rinse well with clean water and allow to dry.
- Check the walls carefully for high spots and remove any tiles or fittings that may interfere with acrylic panel or may create a wavy result when panel is installed.
- Exposed edges can be sealed with silicone. A finishing trim can also be used to create a neat appearance covering both the tile and acrylic panel edge.

Measuring

- Measure each wall area and decide on suitable panel size
- Allow for 4mm joints at each corner and between panels as illustrated in Fig. 6
- Check the installation area is square. If the area is not square or an odd shape, we recommend fabrication of a timber template and trial fitting. Use the template to cut the acrylic sheet to achieve a good result.

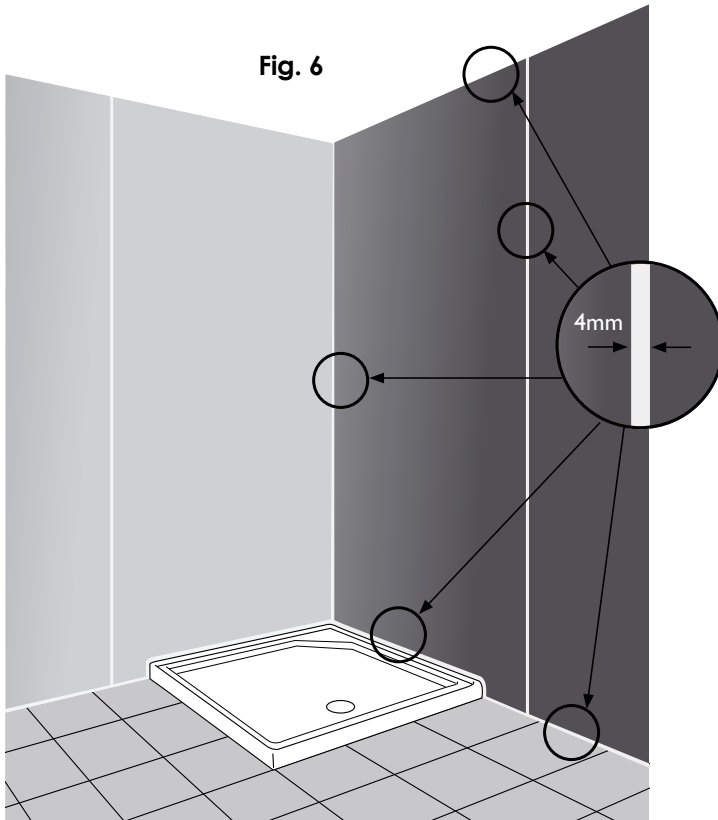

DO RUN THE ACRYLIC PANEL ON TOP OF SHOWER TRAY

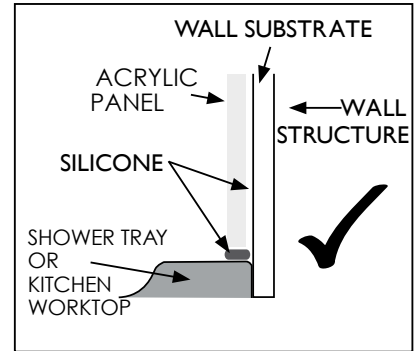

DO NOT RUN THE ACRYLIC PANEL BEHIND SHOWER TRAY

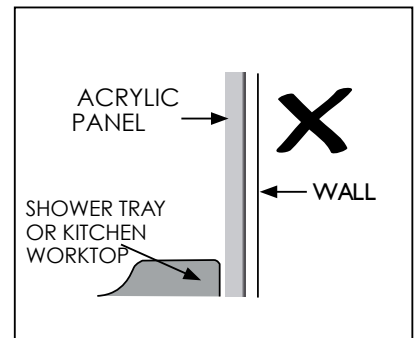

Marking Out



First, it is very important to clearly identify the show face and the rear face - see adjacent diagram

- The acrylic sheet is supplied with a protective film on both sides.
- Do not remove either at this stage
- Mark all holes and cut lines on the film using a felt tip pen, do not use metal scribes
- Do not mark out the sheet in direct sunlight or very cold conditions as thermal expansion/contraction could affect final panel size prior to installation (i.e. below 0°C or above 25°C)
- Do not remove the protective film on the front of the panel until after the installation
- Take care when storing panels on the edge. Use a protective medium to avoid damage

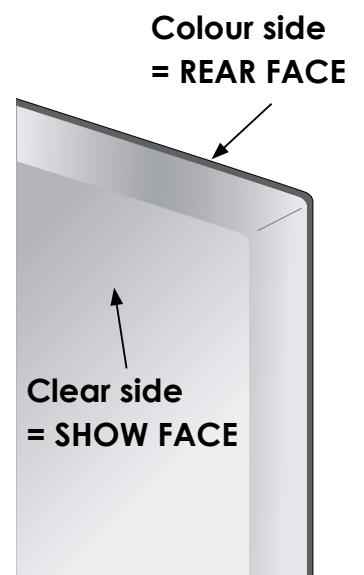

Cutting

- When cutting or drilling, always wear appropriate personal protection equipment relevant to the tool being used. We recommend the use of safety glasses at all times
- Appropriate clamping and support is essential to avoid vibration and potential chipping of the edges.
- Always protect the panel using a non-abrasive material between the clamp and the sheet surface being careful not to damage the surface.
- Using a circular saw will deliver a straight and accurate cut. Best results will be achieved by cutting through the acrylic and into the sacrificial support timber board as illustrated in Fig. 7

SUPPORT THE ACRYLIC PANEL BACK ON PLYWOOD OR MDF SHEET OR SOLID WORK TOP

Fig. 7

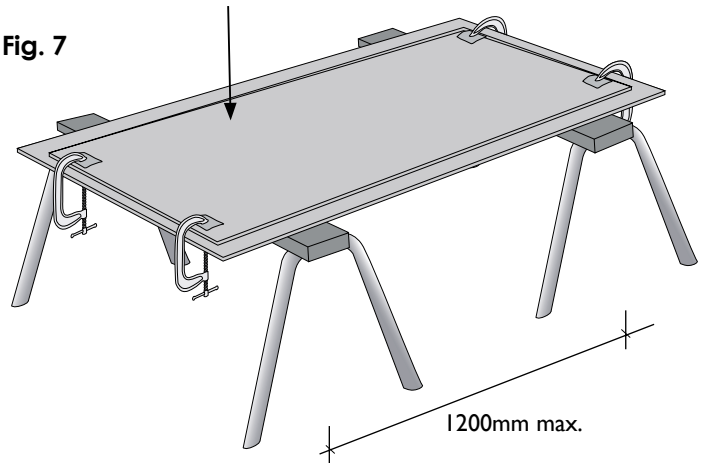

Fig. 8

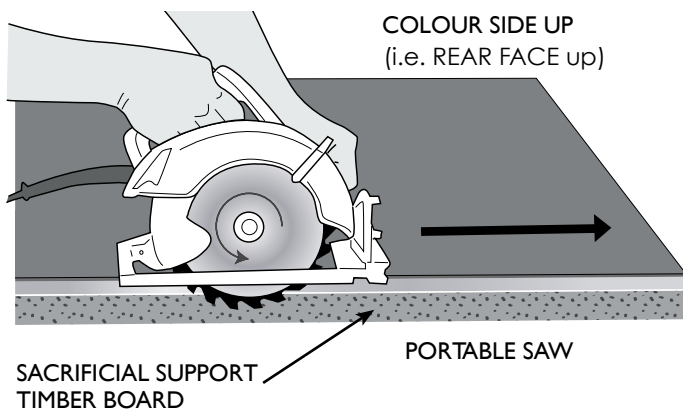
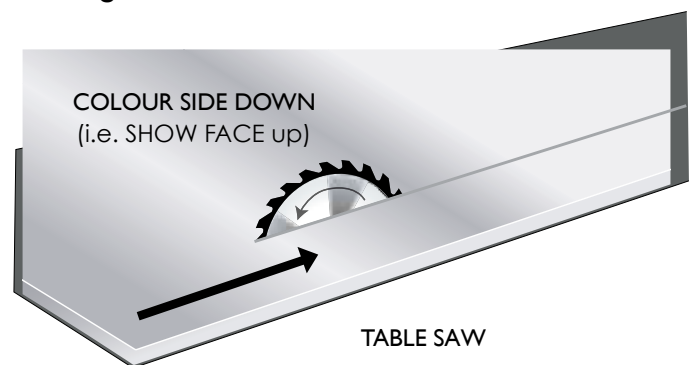

Fig. 9



- To reduce the risk of chipping, when using a portable circular saw, cut with the colour side of the acrylic sheet facing UPWARDS (Fig. 8). If using a fixed table circular saw (Fig. 9), cut with the colour side of the acrylic sheet facing DOWNWARDS
- Jigsaws can be used for cutting short distances such as power point openings. You must only use Jigsaw blades that are suitable for aluminium or plastics. Cut with the colour side of the acrylic sheet facing UPWARDS with a jigsaw
- Do not use Jigsaws to make long cuts. The blade may overheat and melt the sheet at the edge resulting in a poor finish
- Clean swarf away frequently after cutting to avoid damage to the protective film
- A carpenter square is recommended for marking out square cuts in the panels

Cutting Recommendations and Blade Types

- We strongly recommend that acrylic panels should only be cut or shaped at room temperature (approx. 19°C)
- Fine tooth laminate blade
- Jigsaw - Use a fine cut blade that is suitable for plastic or aluminium cutting
- Circular Saw / Plunge Saw - Use a fine tooth carbide tip blade with 60-80 Teeth
- Multi Tool - with fine cutting blade
- Drill Bits - Use a high speed steel tipped drill bit. Do not allow the drill bit to overheat, work at a moderate speed and pressure

Drilling and Openings

- The edge of any drilled holes should be no closer than 10mm to the edge of the panel sheet (A)
- Do not create long openings close to the edge of the sheet, as the sheet will be difficult to handle during the install
- Always drill a hole at the corner of any cut-out or notch. Avoid cutting square inside corners
- Drill from the SHOW FACE side (clear side) of the acrylic sheet to reduce the risk of chipping (C). Best results will be achieved with a slow to medium drill speed, use only light pressure.
- Fine toothed hole saws can be used for larger holes. Cut from the SHOW FACE side (clear side)
- Step drills are ideal for mid size holes and also making smaller holes into larger ones (B)
- When attaching screws or other fittings, drill a hole in the panel with a minimum of 1mm clearance between the fixing and the acrylic panel (F). Fix directly into the substrate behind the panel - DO NOT SCREW INTO THE ACRYLIC PANEL ITSELF AS THIS WILL CAUSE IT TO CRACK.

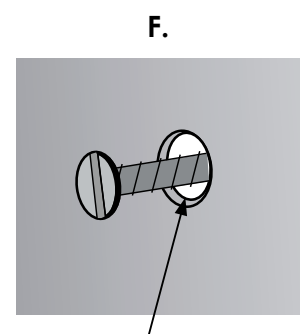
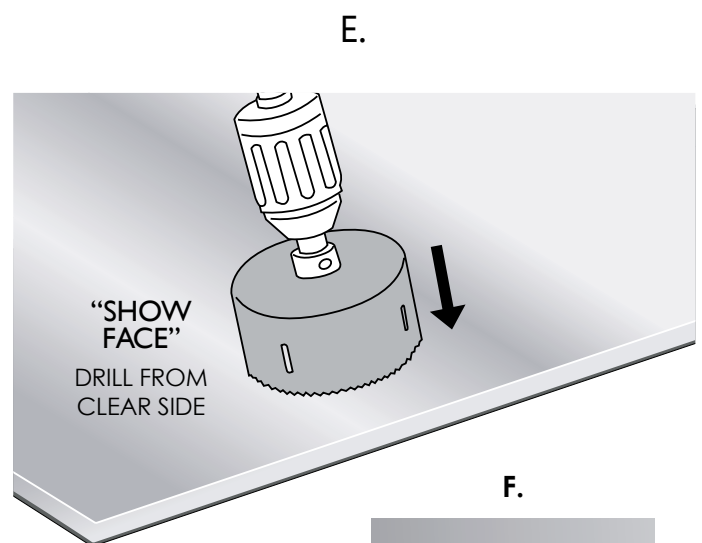
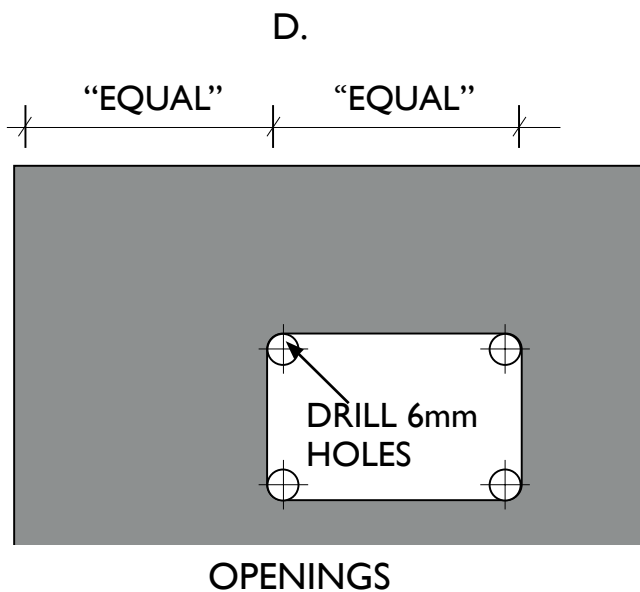
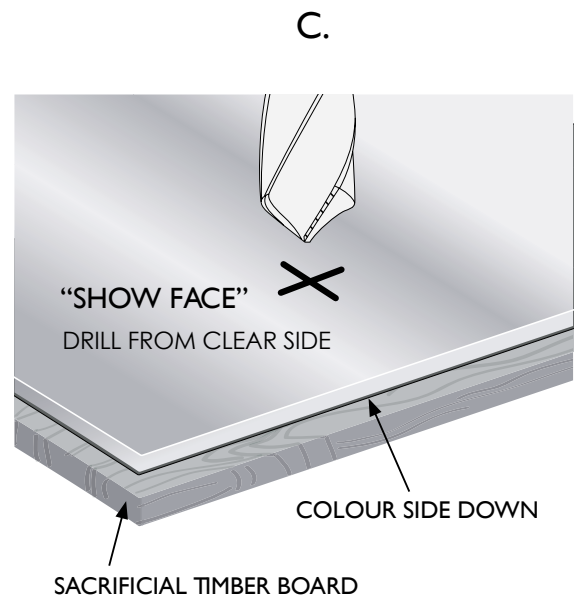
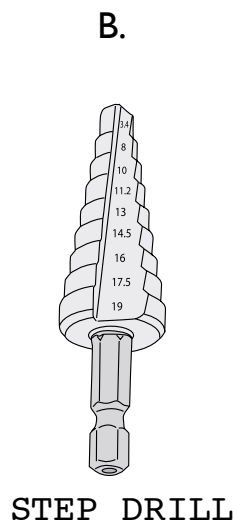
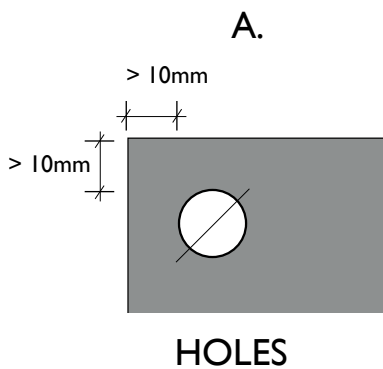

Leave a gap around the screw



Important

DO NOT SCREW INTO THE ACRYLIC PANEL ITSELF AS THIS WILL CAUSE IT TO CRACK.
As Fig. F

Edge Finishing

- **IMPORTANT - All sawn and drilled edges must be sanded or planed prior to installation of acrylic panels to ensure there are no jagged, chipped or cracked edges**
- **Edges can be sanded using medium (120 grit) and then fine (240 grit) emery paper. Use a sanding block to give a smooth flat edge finish**
- A single pass with an electric planer will provide a smooth edge and neat appearance



NOTE - Do not use flexible PVC edge trimming (such as tile trim) or gaskets at any time as they contain chemical agents that could damage the sheet.

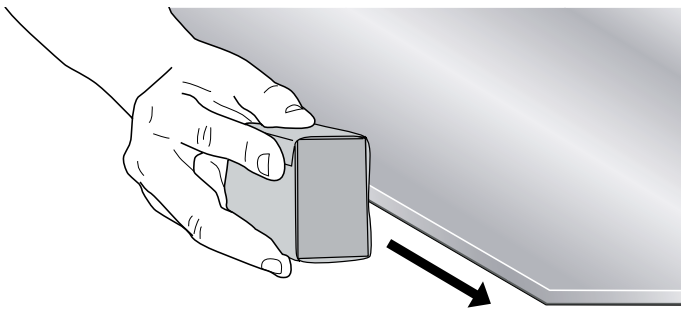

BLOCK SANDING

STEP 1: MEDIUM 120 GRIT
STEP 2: FINE 240 GRIT

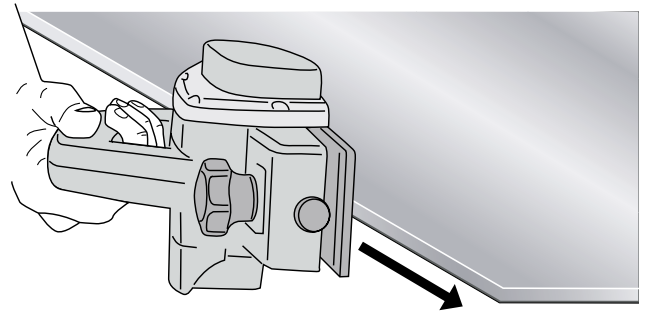

ELECTRIC PLANER

Profiles and Aluminium Splash Protectors

- Aluminium Splash Protectors are available for use behind electric, ceramic or induction hobs. These can either be installed on the surface of the acrylic panel using neutral cure silicone or they can be installed flush with the panel as they are the same thickness (4mm)
- Profiles are also available in Matt Aluminium finish as shown below in either 2500mm or 1250mm length as an alternative option for silicon joints
- If using the optional edge profiles for the acrylic panels as shown above, please refer to the individual profile fitting instructions supplied with the profiles.

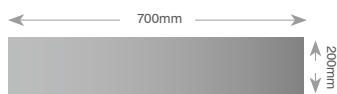
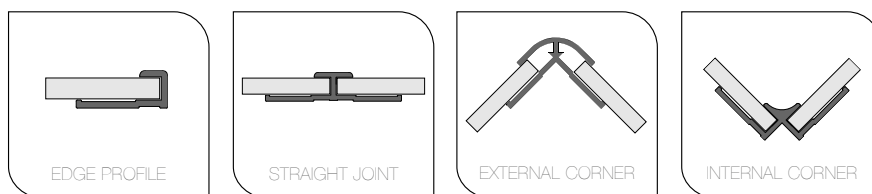

Aluminium Splashback Protectors
700 x 200 x 4mm

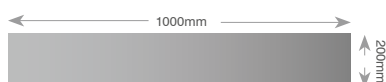

Aluminium Splashback Protectors
1000 x 200 x 4mm

Panel Installation

- STEP 1 -** Remove the protective film from the REAR FACE (i.e. colour side). **DO NOT** remove the protective film on the front (clear side) of the panel at this time
- STEP 2 -** Scuff the REAR FACE (colour side) with coarse scouring pad or 120 grit emery paper as shown below in order to create a strong adherence to the substrate
- STEP 3 -** Remove sanding dust with clean cloth
- STEP 4 -** After scuffing, ensure the REAR FACE (colour side) is clean and free of dust or any other substance before applying the tape and silicone adhesive
- STEP 5 -** Apply the 15mm x 1.5mm thick double-coated polyethylene foam tape with synthetic rubber adhesive on the rear surface of each acrylic panel. Firmly secure the tape to the panel. **Note:** The silicone and tape are applied to the COLOUR SIDE i.e. the REAR FACE . The clear side "show face" must face outwards
- STEP 6 -** Trial fit each panel with tape applied to ensure trim size and expansion gaps are correct (4mm)

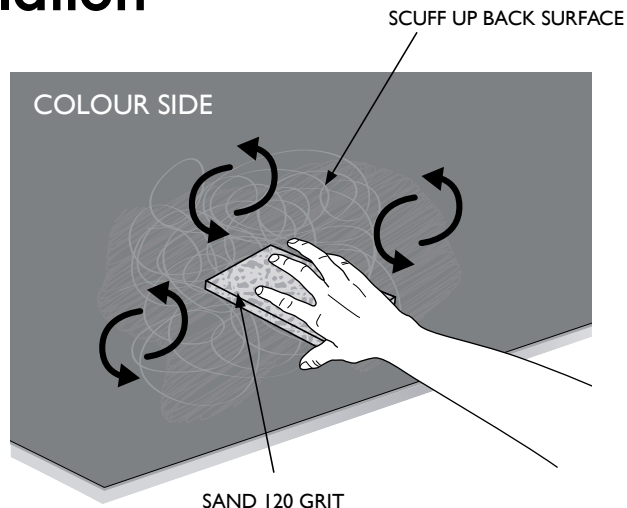

FOR LARGE PANELS

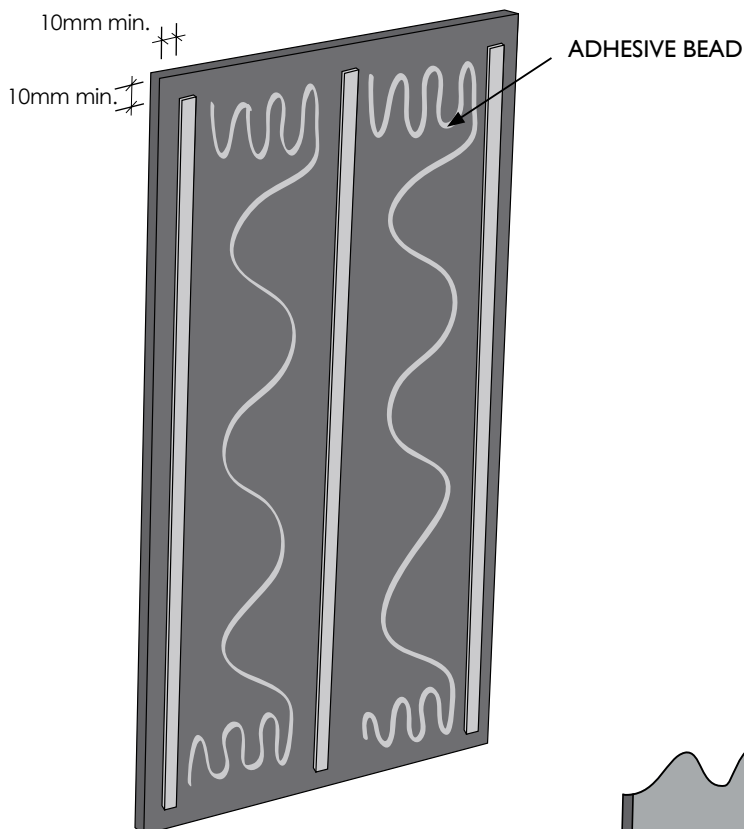

USE 4mm SPACERS & LEVELING WEDGES UNDER SHEETS AND AT JOINTS

FOR HOLES AND OPENINGS

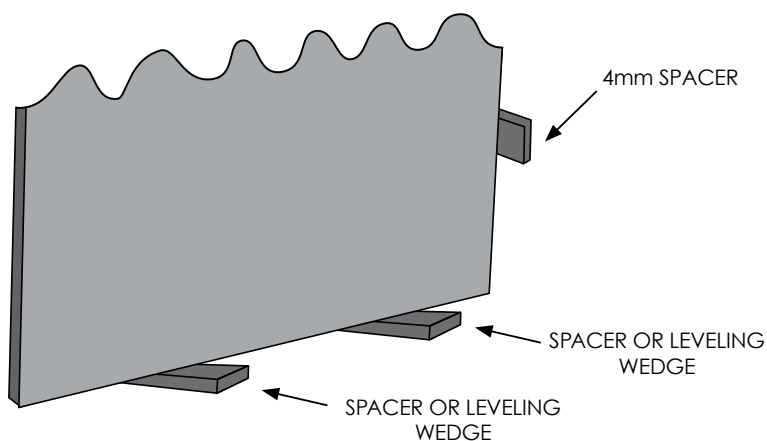
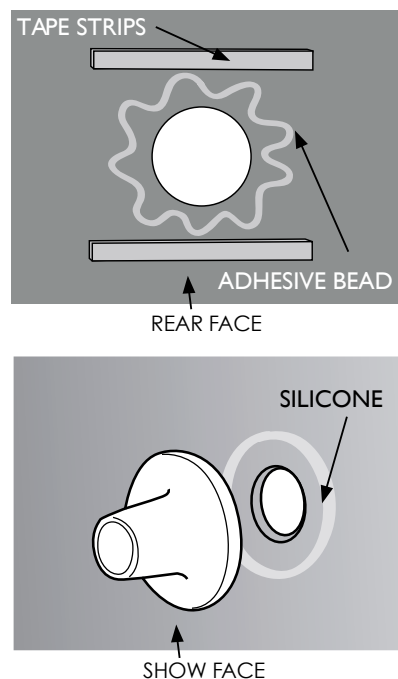

Panel Installation

- STEP 7 -** Apply a 6mm wide bead of translucent neutral cure silicone in a wavy pattern between each tape strip as shown. Near the edges of the panel, increase the wavy pattern as show in the figure. Run a bead of silicone on the rear of the panel around any holes or cut outs. **NOTE:** Always use a neutral cure silicone
- STEP 8 -** Remove the self-adhesive tape liner
- STEP 9 -** Install the panel by resting on removable spacers or wedges at the bottom and use 4mm spacers between the panels
- STEP 10 -** Firmly rub down panel to ensure tape bonds and adhesive contacts the wall. Allow to cure for 24 hours
- STEP 11 -** Remove the spacers and seal the joints, including all edges of the panel/s such as the floor, the top of the panel/s and all vertical edges with your neutral cure wet area silicone as Fig. 10. If the outer protective film of the panel is damaged or not adhered well, peel approximately 40mm of the protective film from panel edges and carefully apply 20mm masking tape either side of the joint. Once gap is filled, remove excess silicone using a soft flexible plastic spatula **NOTE:** To achieve a smooth finish on the silicone, mix up a 10% solution of mild detergent and water. Spray the solution over the silicone bead before wiping off with the spatula as Fig. 13

Important notes:



- DO NOT** use Acetic cure silicone. Always use a neutral cure silicone
- DO NOT** use Acrylic sealant as it will not bond to the panels
- VERY IMPORTANT** For corner joints without a trim please see Fig. 11 for panel positioning

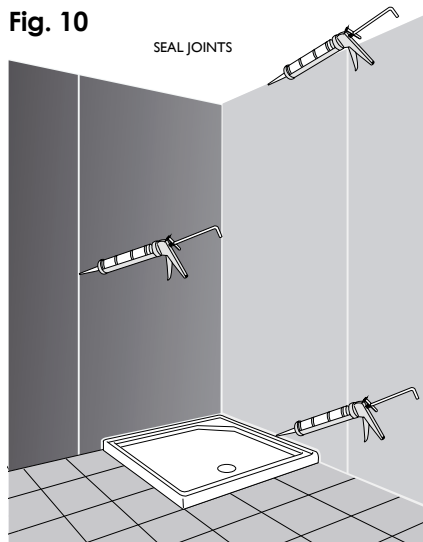

Fig. 11

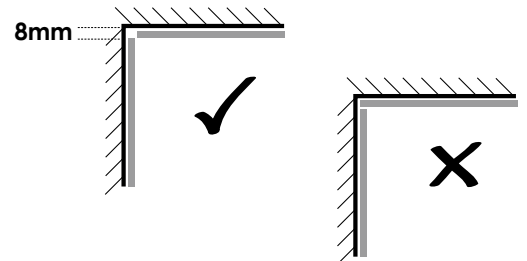

Fig. 12

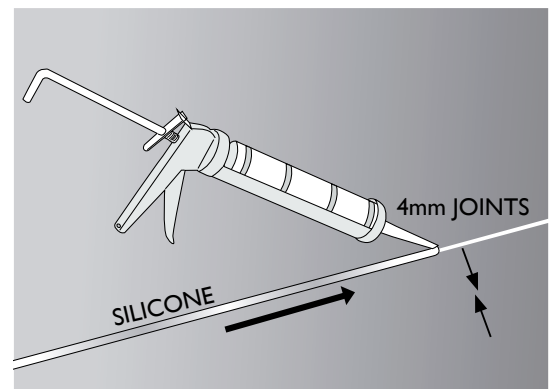
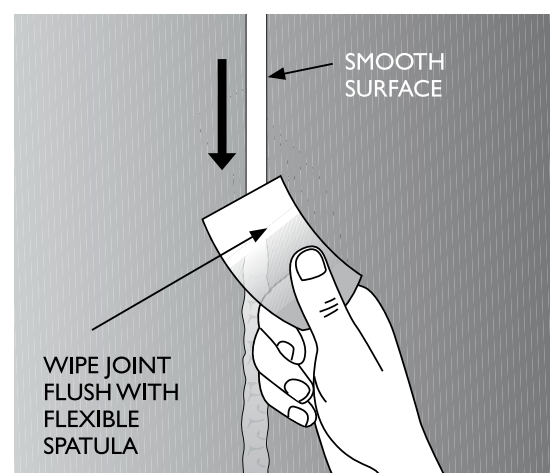

Fig. 13



Panel Installation

STEP 12 - Immediately after the silicone is applied, carefully remove the outer protective film or masking tape in one continuous movement to achieve the best finish as Fig. 14

Fig. 14

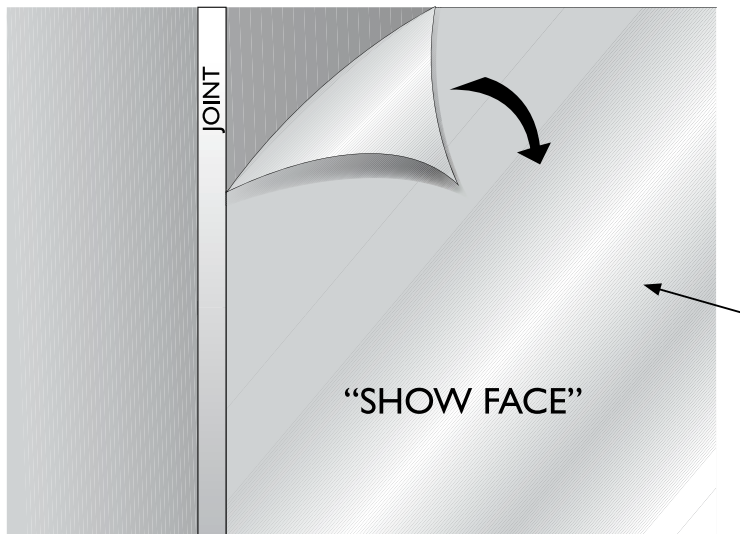

Leave for 24 hours and then you can enjoy using your acrylic panels

After Care

We recommend you have sufficient ventilation in the bathroom as per general building regulations in order to reduce condensation.

For cleaning, best results are achieved using soft microfibre cloth or chamois with non-abrasive detergent in warm water. Always rinse off with clean water.



DO NOT use brushes or scouring pads on the acrylic as prolonged use may damage the high polished surface

DO NOT use cleaners with high alkaline content such as concentrated bleach.

Chemicals Tested

The acrylic panel is suitable to use with typical soap, liquid soap, shampoo and conditioners.

The acrylic panel is compatible with cleaners such as:-

- Mr Muscle 5 in 1 Bathroom & Toilet Cleaner
- CIF Bathroom Cleaner Trigger Spray
- Ecover Multi action cleaner
- Naturally Powered multi Surface Lemon Spray
- Method All Surface Cleaner



Guarantee and Technical Details

GENERAL PROPERTIES		METRIC	
		DATA	UNIT
Water Absorption	ASTM D-570	< 0.5	%
Gloss	AS/NZS 1580.602	> 90	%
Abrasion (Taber, 10 rots. CS10F 500g)	ASTM D-1044	< 10	% Gloss
Pencil Hardness	ASTM D-3363	> 6	H
Thermal Expansion & Contraction		0.7mm/1000mm/10 °C	
HDT, 264psi, 1.82MPa	ASTM D-648	96	°C
CTE, -30 to 30C	ASTM D-696	7	mm/(mm.°C)x10 ⁻⁵
Continuous Service Temperature		77	°C
Fire Behaviour - Australia BCA 2006	AS/NZS 13837:1998	Rating 4	

5 Year Limited Warranty

Acrylic panels are manufactured using the most advanced technology available, however, there can be minor surface blemishes up to 1.0 millimetres in diameter inherent to the process. Any surface blemish should not be visible from a distance of 1 metre in normal light conditions with the panel positioned vertically.

Acrylic panels are warranted for manufacturing defects for a period of 5 years. The warranty is void if incorrect installation or cleaning procedures have been used. The warranty does not include fabrication, installation, trade services or other consequential costs.

For technical assistance please contact
your merchant.

1. The manufacturer expressly disclaims any representations or warranties of any kind, whether express or implied, as to the accuracy, currency, completeness and/or the merchantability or fitness for a particular purpose of any information contained in or provided via this documentation and/or any service or product described or promoted in this document. 2. It is the customer's responsibility to thoroughly examine intended use of the product by a qualified person, to determine whether it is suitable for the application it was purchased for. 3. The receiver of our products is fully responsible to check and to take into account possible third party's patent rights, as well as the existing laws in the country of installation prior to installing our product. 4. No liability may be derived from these images or statements. 5. Printed images are to be used as a guide only.

